

YE-IT24
EUROPE
2023/2024



CUTTING TOOLS



INDEXABLE INSERTS

YG YG-1 CO., LTD.



INDEXABLE INSERTS

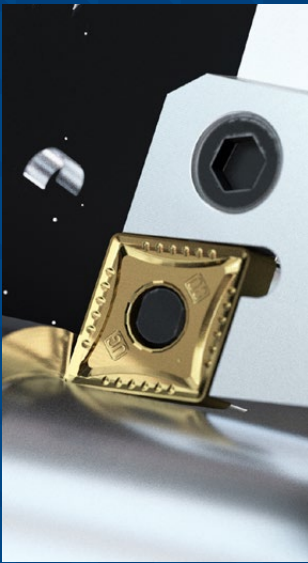

TURNING



**PARTING
GROOVING**



MILLING

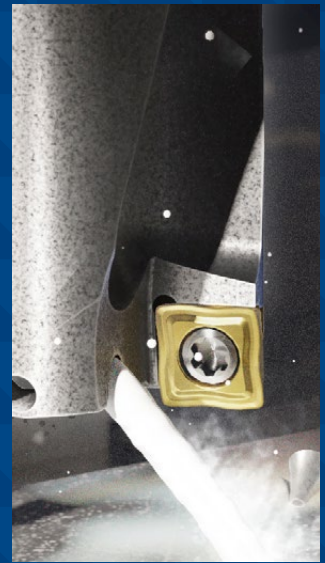

DRILLING

Turning
New Product



YG TURN YG3115 ^{NEW}

First choice grade for high cutting speed in Steels

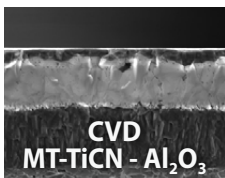

YG3115

P10 - P25

First choice grade for high cutting speed in Steels

- Suitable for mass production due to stable and predictable tool life
- Minimizing built up edge due to new post surface treatment in mild steels, low carbon steel and low carbon alloy steel.
- Best choice for both continuous as well as interrupted cuts

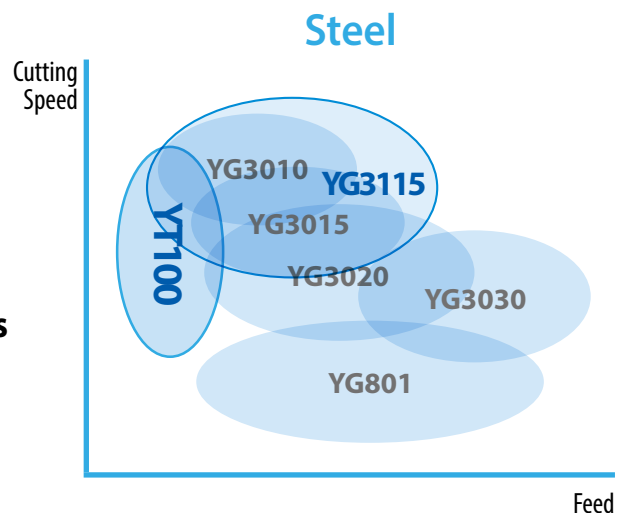

Turning
New Product

YG TURN YG2025

NEW

High Cutting Speed for Stainless steels

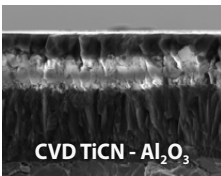

CVD TiCN - Al₂O₃

YG2025

M15 - M35

CVD grade for High Cutting Speed for Stainless steels

- Utilizing a new carbide substrate and new coating
- Excellent combination of wear resistance and chipping resistance
- Minimized built up edge due to post surface treatment

Stainless steel

Cutting Speed

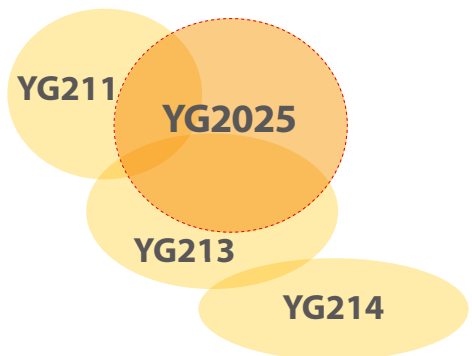

Feed

Turning
New Product

YG TURN YT100

Cermet Turning Grade

NEW

Grades

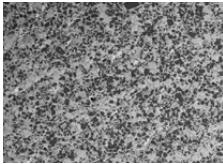

<Micro structure>

YT100 P10 - P20 M10 - M20 K10 - K20

- Enhanced wear resistance & chipping resistance
- Excellent fracture resistance
- Superior surface finish with special edge preparation

Chipbreakers

PSF

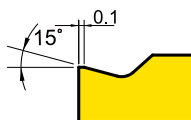

- For negative chip breaker insert
- 3 dimensional chip breakers give low cutting force
- For semi-finishing to semi-medium

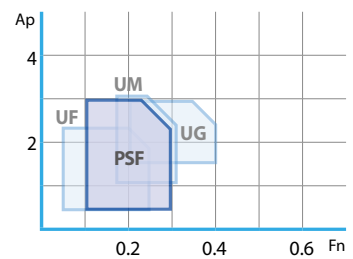

PF



- For positive chip breaker insert
- Excellent chip breaking at small depth of cut and low feed rate
- Good for low carbon contents steel in Finishing

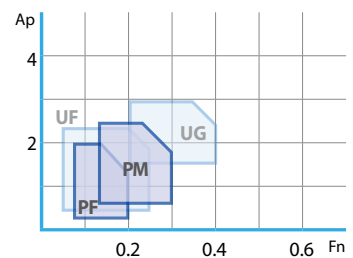

PM

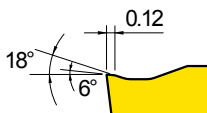

- For positive chip breaker insert
- High positive rake angle
- Good for low carbon contents steel
- For medium

Turning
New Product

YG TURN UT, UH

NEW

Single sided inserts for heavy turning

Chipbreakers

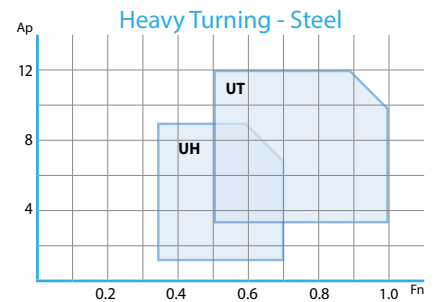

Features

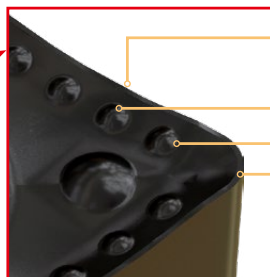
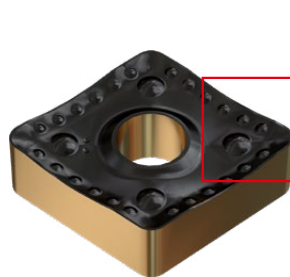
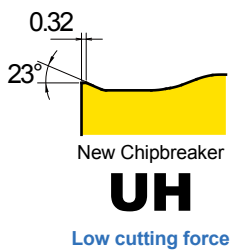

- ① Reduce cutting force due to the helix angle on the cutting edge
- ② The central dot helps chip breaking to be efficient
- ③ Decoration dot reduces friction area and helps heat release
- ④ Insert corner radius range available from 1.2mm to 2.4mm

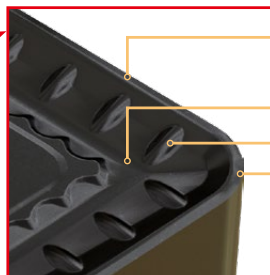
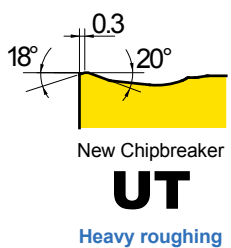

- ① Reinforced edge type with high rigidity and is suitable for irregular surface cutting
- ② Chip breaker is formed widely, suitable for heavy roughing application
- ③ Decoration dot reduces friction area and helps heat release
- ④ Insert corner radius range available from 1.2mm to 2.4mm

Turning
New Product

YG NanoCut Solid Miniature Turning for small bore applications

NEW

Overview

At present, as demand for small parts (camera lens, mobile phone parts) and medical instruments (implants) increases, demand for small-diameter products capable of high-precision processing is increasing.

Application

- Turning of Small Bore Components
- Internal Turning(Boring), Grooving and Threading

Features

- Minimum Diameter(Boring & Profiling series) : \varnothing 1 mm
- Internal Coolant for Longer Tool life and Enhanced Chip Evacuation
- Secure Connection Design: Pin + Slant Positioning
- 9 Geometries for Various Applications

Benefits

- Reduced Machine Down Time
- Lower Machining Cost

Advantages of Nanocut

Easy Clamping

Secure and Simple system for fast change and fast locking

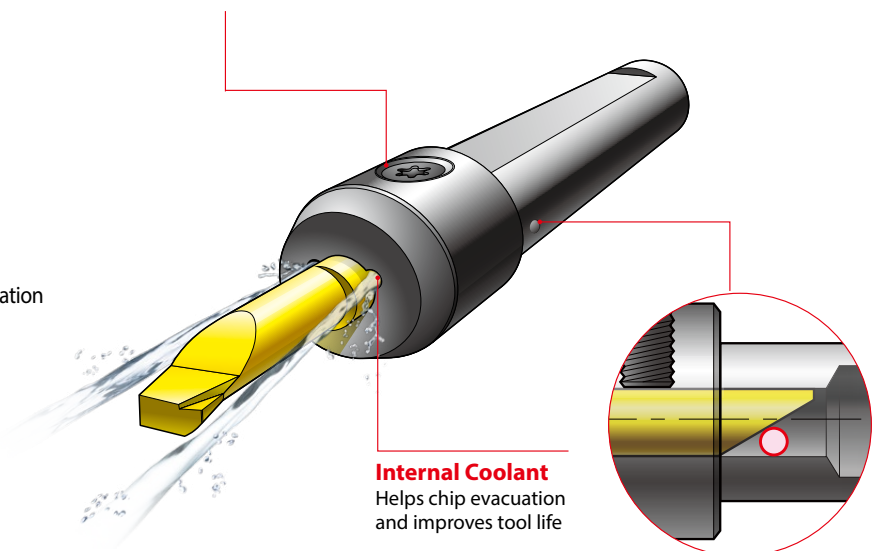

Internal Coolant
Helps chip evacuation
and improves tool life

Secure Slant Connection
Ensures High repeatability for
height and axial position

YG812 - Micro Grain Carbide Grade

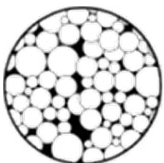

P10 - P20

M20 - M30

K20 - K30

S10 - S25

Submicron Grade Carbide Substrate Material for high toughness and wear resistance realizes high precision machining

Turning
New Product

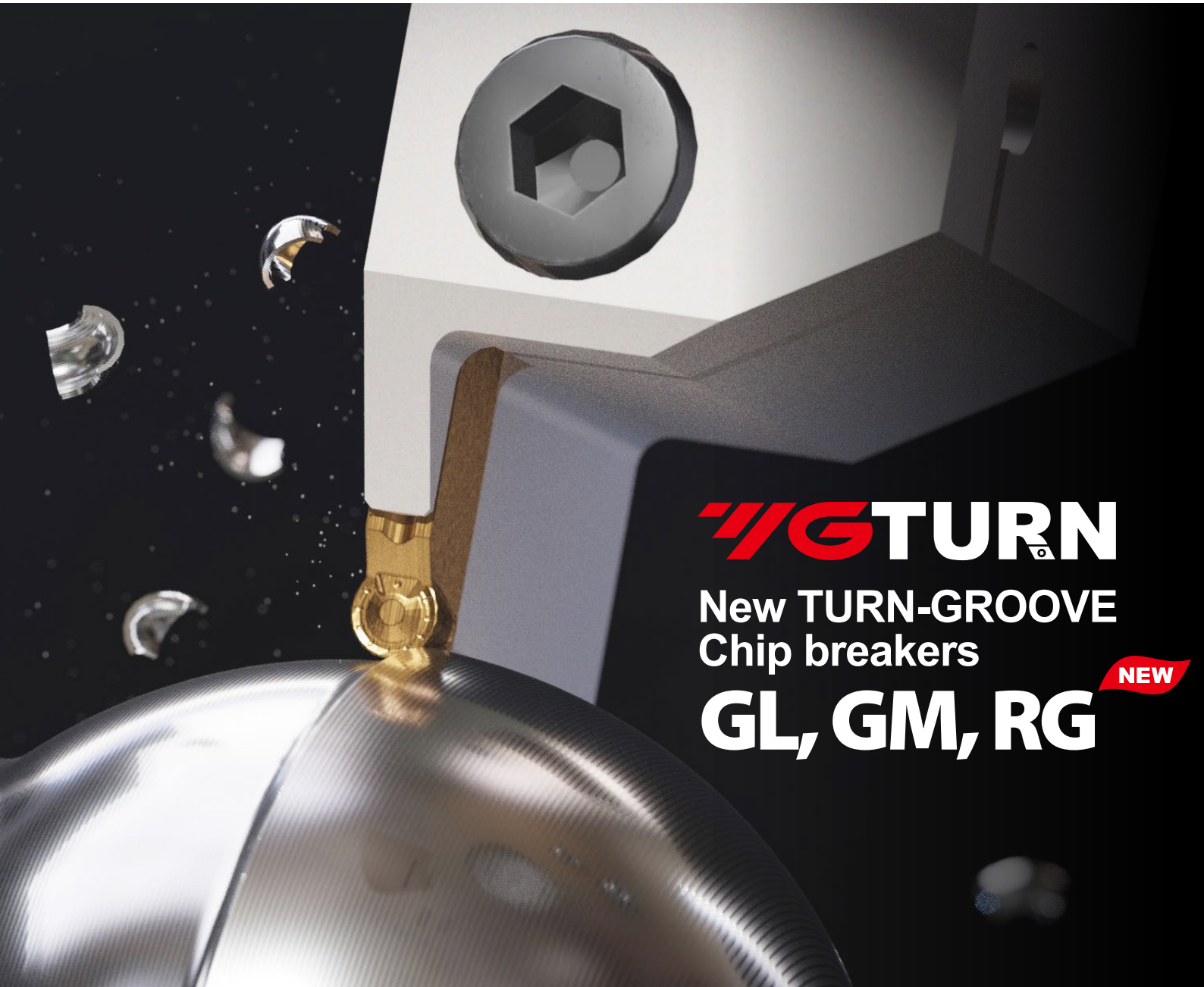







YG TURN

New TURN-GROOVE
Chip breakers

GL, GM, RG

NEW

TURN-GROOVE Chip breakers

Turning & Grooving	GL			<ul style="list-style-type: none"> • For External, Internal turning and grooving • Face grooving and Face turning • For low feed rate
	GM			<ul style="list-style-type: none"> • For External, Internal turning and grooving • First choice face grooving and Face turning • For medium feed rate
	RG			<ul style="list-style-type: none"> • For External, Internal turning and grooving • Full radius Insert for profiling

Milling
New Product

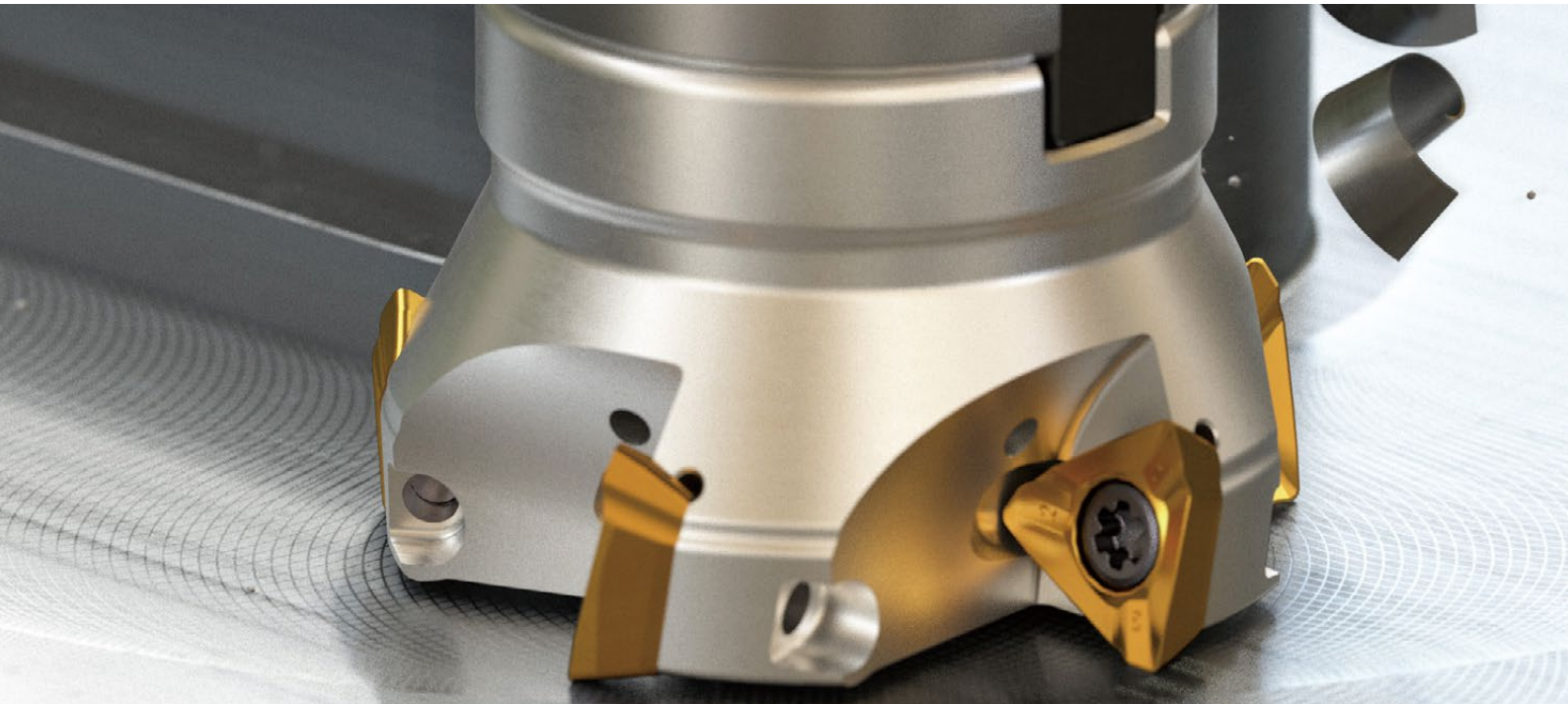

SM3 YG MILL TPKT **NEW**

True 90 degree Shoulder Milling

- 3 Cutting Edges for Shoulder Milling
- High Positive Helical Cutting edge
- Higher Cost Efficiency than 2 Cutting edges
- Wide selection and Optimal Machining with Various Cutters and Inserts

Features

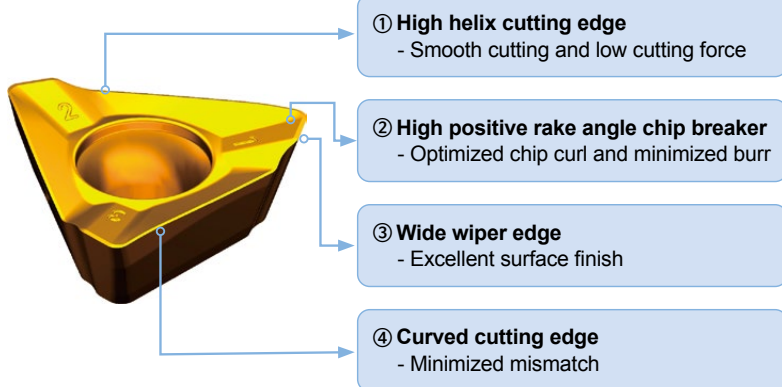

Applications

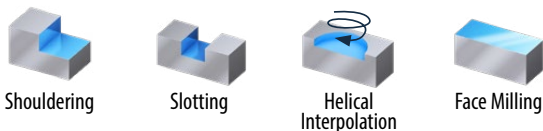

Key Technology



True 90°
shoulder milling



Larger core size
- Higher rigidity



Optimal insert placement
- More inserts for high productivity

Milling
New Product



YG MILL WNEX NEW

6 cutting edges for Shouldering

Applications

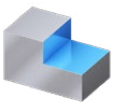

Shouldering

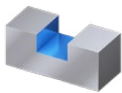

Slotting

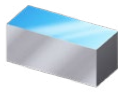

Face Milling

Features

- 6 cutting edges for Shouldering - High Cost-Efficiency
- High Positive Helical Cutting edge
- High Chipping Resistance with Reinforced cutting edge
- Ground Insert – High Precision Tolerance and Excellent Surface finish
- Diameter range : $\varnothing 32 \sim \varnothing 200$
- A_p (max) : 7mm

Key Technology

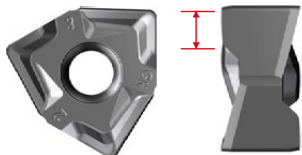

Wider wiper edge length

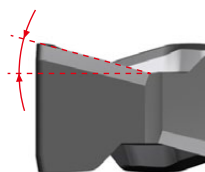

High Helix cutting edge



Unique Chip groove

Drilling
New Product



X-DRILL SYMXX

with highly efficient hole making solution

Features

- Economic square type 4 cutting edge insert
- One kind of insert in outer and inner pocket
- Twisted coolant channel and enlarged chip gullet for better chip evacuation
- Highly durable drill body due to high hardness and optimized material
- New post surface Treatment flute enables to improved chip evacuation in deeper machining

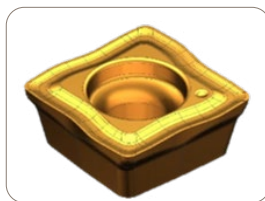
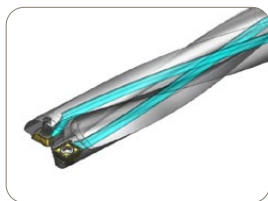
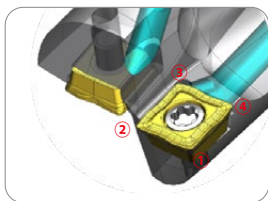



Key Technology

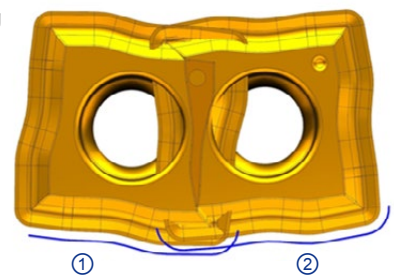

- Unique 1 chip curl per each flute
- True 4 cutting edges are available



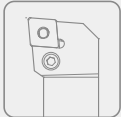
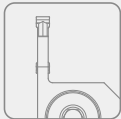

Click/Touch each page number
and move to the very page!

Contents		Page			
Code System	External Turning Holder Code	16			
	Internal Turning Holder Code	18			
	Insert ISO Code System	20			
	Grade Naming System	22			
Grades & Chipbreakers	Turning Grades Map	23			
	Turning Grades	24			
	Turning Chipbreakers	26			
Turning					
		Inserts Overview	Inserts Overview	29	
		Inserts Product	Negative Inserts	30	
			Positive Inserts	57	
		Holders Overview	External Holders Overview	68	
			Internal Holders Overview	70	
		Holders Product	External Holders	72	
			Internal Holders	93	
	Parting & Grooving		Overview	Parting & Grooving Overview	118
			Inserts & Holders Product	Parting & Grooving Inserts	119
Parting & Grooving Holders				120	
		Code System	Code Keys - Boring bar & Holder	129	
		Overview	Boring bar Insert & Holders Overview	130	
			Boring bar Series & Index	131	
	Product	Boring bar Inserts	132		
		Boring bar Holders	141		

		Contents	Page
Milling 	Code Keys	Milling Cutter Code Keys	143
		Insert ISO Code System	144
	Grades & Chipbreakers	Milling Grades and Chipbreakers	146
	Inserts	Milling Inserts Overview	148
		Milling Inserts	149
	Cutters	Milling Cutter Overview	176
Milling Cutters		178	
Drilling 	Overview	Drilling Grades and Chipbreakers	199
	Product	Drilling Inserts	200
		Drilling Holders	203
Technical Information	Technical Information	ISO 13399 Terms	219
		Hardness Conversion Table	220
		Formulas	221
	Cutting conditions	Recommended cutting conditions	222
		Material Groups	224
	Application Guide	Application Guide	241
		Surface Roughness Guide	247
		Trouble Shooting	248
	Comparison Chart	Comparison Chart - Turning	251
		Comparison Chart - Milling	253
	Search	ISO ↔ ANSI	254
Search		255	

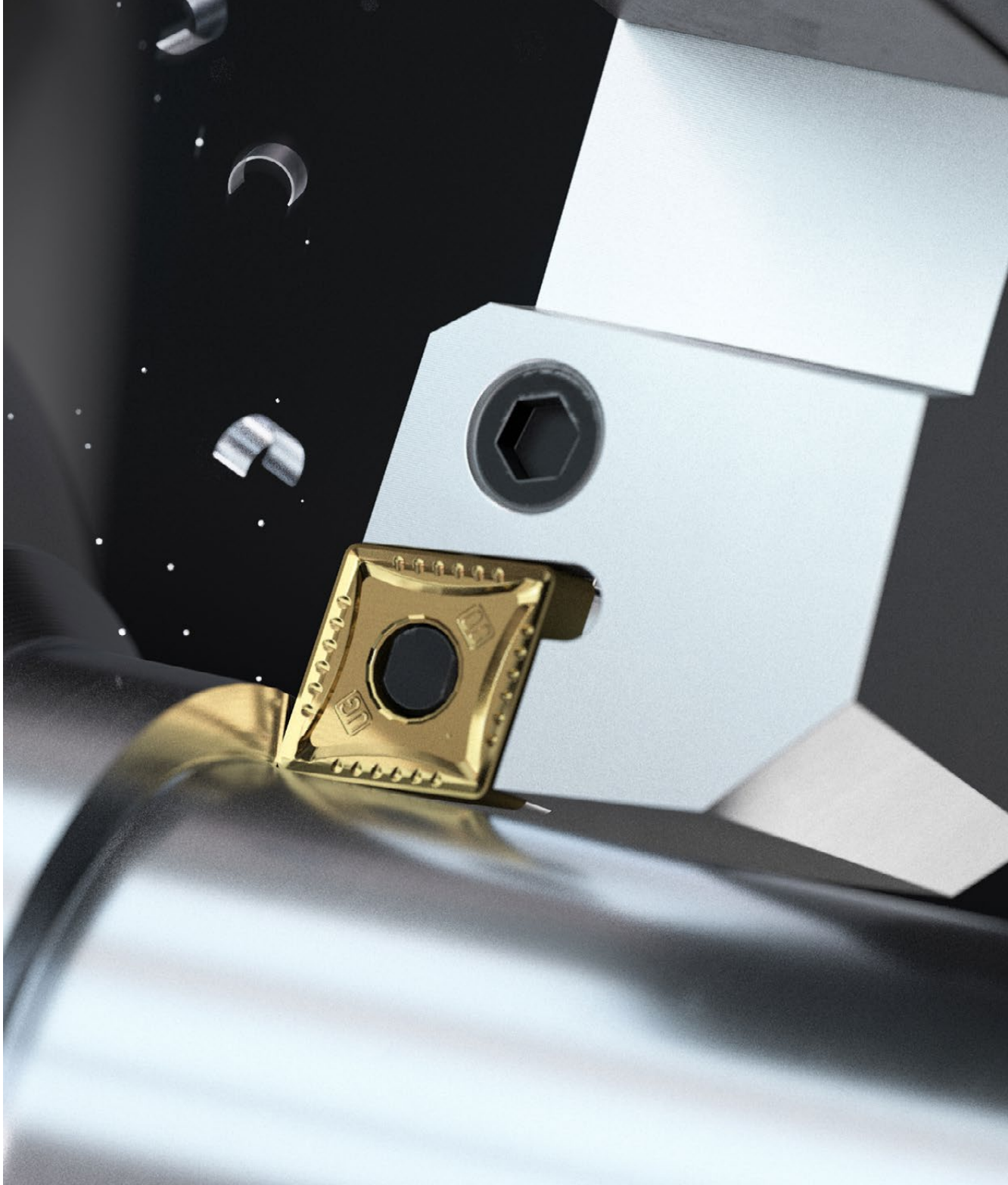

ISO TURNING

Product Overview

Application Guide

Turning Inserts Overview

Turning Inserts

Turning Holders Overview

Turning Holders

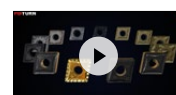

**Click this
QR code!!** 



Scan this QR code
to see our
Turning Grades
at work.

Turning - Name Code System

External Turning Holder Code

1	2	3	4	5	6	7	8	9	10
P	C	L	N	R	25	25	M	12	(C)
Clamping System	Insert Shape (1st Letter of Insert)	Tool Style	Insert Clearance (2nd Letter of Insert)	Tool Hand	Shank Height (H)	Shank Width (B)	Length (LF)	Insert Size	(Optional Clamp)

1 - Clamping System

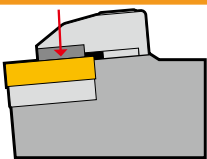
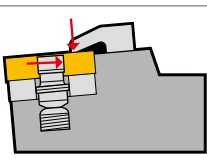
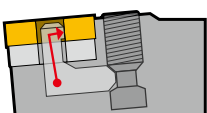
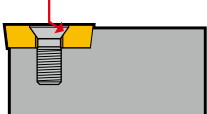
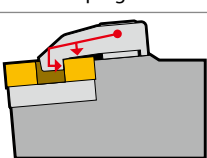





Symbol	System
C	 <p>Top Clamp (No Clamping Hole Insert)</p>
M	 <p>Multi lock (Straight Clamping Hole Insert)</p>
P	 <p>Lever Lock (Straight Clamping Hole Insert)</p>
S	 <p>Screw Clamp (Screw Clamping Hole Insert)</p>
T (D, A)	 <p>Double Clamp (Straight Clamping Hole Insert)</p>

2, 4 - Insert Compatibility *

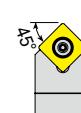

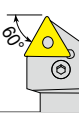
* Related to Insert Designation to check compatibility
* Refer to '1-shape' of page 20

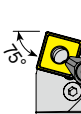
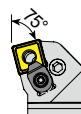
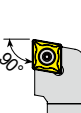
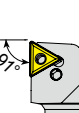
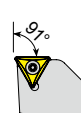
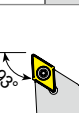
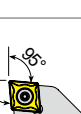
3 - Tool Style

Approach Angle (KAPR)	Side Direction		End Direction
	Straight Shank	Offset Shank	
45°	D 	S 	
60°		T 	
63°	N 		
72.5°	V 		
75°	B 		K 
90°/91°	A 	G 	F 
93°		J 	U
95°		L (Both Direction) 	
107.5°		H 	

Turning - Name Code System

External Turning Holder Code

1	2	3	4	5	6	7	8	9
S	D	J	C	R	20	20	K	11
Clamping System	Insert Shape (1st Letter of Insert)	Tool Style	Insert Clearance (2nd Letter of Insert)	Tool Hand	Shank Height (H)	Shank Width (B)	Length (LF)	Insert Size

5 - Hand Direction

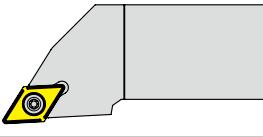
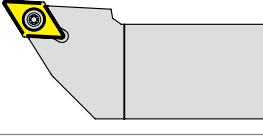
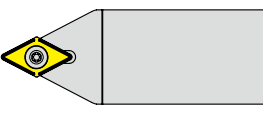
Symbol	Hand Direction
R	Right Hand 
L	Left Hand 
N	Neutral 

8 - Length (LF)

Symbol	Length (mm)	Symbol	Length (mm)
E	70	Q	180
F	80	R	200
H	100	S	250
K	125	T	300
M	150	U	350
P	170	V	400

6, 7 - Shank Height (H) Shank Width (B)

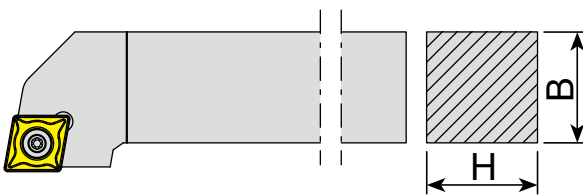

9 - Insert Size *

Examples	is Compatible with...
PCLNR 2525M 12	CNMG 1204**
SCLCR 2020K 09	CCMT 09T3**
TWLNr 2525M 08	WNMG 0804**

* Related to Insert Designation to check compatibility

(10 - Optional Clamp)

Symbol	Optional Clamp
C	Included

Internal Turning Holder Code

*Metric

1	2	3	4	5	6	7	8	9	10	
A	32	S	-	P	W	L	N	R	12	(C)
Coolant & Material	Shank Diameter (DCON)	Legth (LF)	Clamping System	Insert Shape (1st Letter of Insert)	Tool Style	Insert Clearance (2nd Letter of Insert)	Tool Hand	Insert Size	(Optional Clamp)	

1 - Coolant and Tool Material

Symbol	Internal Coolant	Tool Material
A	O	Steel
S	X	
E	O	Carbide
C	X	Carbide

2 - Shank Diameter (DCON)

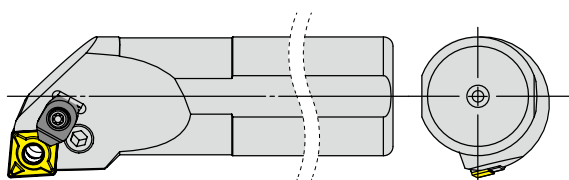

3 - Length (LF)

Symbol	Length (mm)	Symbol	Length (mm)
E	70	Q	180
F	80	R	200
H	100	S	250
K	125	T	300
M	150	U	350
P	170	V	400

4 - Clamping System

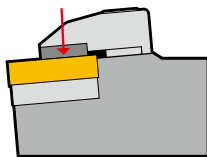
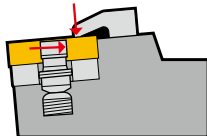
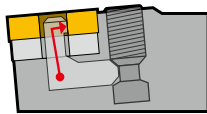
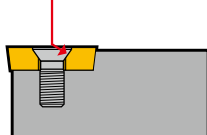
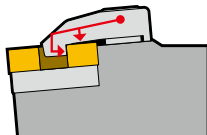
Symbol	System
C	 Top Clamp (No Clamping Hole Insert)
M	 Multi lock (Straight Clamping Hole Insert)
P	 Lever Lock (Straight Clamping Hole Insert)
S	 Screw Clamp (Screw Clamping Hole Insert)
T (D, A)	 Double Clamp (Straight Clamping Hole Insert)

Turning - Name Code System

Internal Turning Holder Code

*Metric

1	2	3	4	5	6	7	8	9
A	25	R	-	S	C	L	C	09
Coolant & Material	Shank Diameter (DCON)	Length (LF)	Clamping System	Insert Shape (1st Letter of Insert)	Tool Style	Insert Clearance (2nd Letter of Insert)	Tool Hand	Insert Size

6 - Tool Style

Approach Angle (KAPR)	Side Direction	End Direction
	Offset Shank	
75°		K
91°		F
93°	J 	U
95°	L (Both Direction) 	
107.5°		Q

8 - Hand Direction

Symbol	Hand Direction	
R	Right Hand	
L	Left Hand	

9 - Insert Size *

Examples	is Compatible with...
PCLNR 2525M 12	CNMG 1204**
SCLCR 2020K 09	CCMT 09T3**
TWLNR 2525M 08	WNMG 0804**

* Related to Insert Designation to check compatibility

5, 7 - Insert Compatibility *



* Related to Insert Designation to check compatibility
 * Refer to '1-Shape' of page 20

(10 - Optional Clamp)

Symbol	Optional Clamp
C	Included

Insert ISO Code System

*Metric : According to ISO 1832

page 14

page 12

1	2	3	4	5	6	7	8	9
C	N	M	G	12	04	08	-UG	YG3115
Shape	Clearance	Tolerance	Clamping & Chipbreaker	Insert Size	Insert Thickness	Corner Radius	Chipbreaker Geometry	Grade

1 - Shape

Symbol	Shape	
H	Hexagonal	
O	Octagonal	
P	Pentagonal	
S	Square	
T	Triangular	
C	Rhombic 80°	
D	Rhombic 55°	
V	Rhombic 35°	
W	Trigon	
L	Rectangular	
K	Parallelogram 55°	
R	Round	

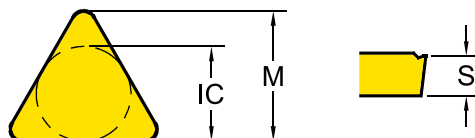

3 - Tolerance Class

Symbol	Inner Circle IC (mm)	Nose Height M (mm)	Thickness S (mm)
C	± 0.025	± 0.013	± 0.025
E	± 0.025	± 0.025	± 0.025
G	± 0.025	± 0.025	± 0.13
H	± 0.013	± 0.013	± 0.025
K*	± 0.05~0.15*	± 0.013	± 0.025
M*	± 0.05~0.15*	± 0.08~0.2*	± 0.13
U*	± 0.08~0.25*	± 0.13~0.38*	± 0.13

* Tolerance is different by insert IC size. Please see ISO 1832

2 - Relief Angle (AN)

Symbol	Relief Angle (AN)	
N	No Relief Angle	
B	Relief 5°	
C	Relief 7°	
P	Relief 11°	
D	Relief 15°	
E	Relief 20°	
F	Relief 25°	
O	Special	

4 - Clamping & Chipbreaker

Symbol	Clamping	Chipbreaker	Figure
N	No clamping hole	X	
R		One Face	
A	Cylindrical Clamping hole	X	
M		One Face	
G		Both Faces	
W	Screw Hole	X	
T		One Face	
U		Both Faces	
X		Special	

Insert ISO Code System

*Inch

page 14

page 12

1	2	3	4	5	6	7	8	9
C	N	M	G	4	3	2	-UG	YG3115
Shape	Clearance	Tolerance	Clamping & Chipbreaker	Insert Size	Insert Thickness	Corner Radius	Chipbreaker Geometry	Grade

5 - Insert Size

Metric							Inner Circle IC (mm)	Inch
S	T	C	D	V	W	R		
06	11	06	07	11			6.35	2
07	13	08	09	13	15		7.94	2.5
09	16	09	11	16	06	09 (00)	9.525	3
12	22	12	15	22	08	12 (00)	12.7	4
15	27	16	19	27	10		15.875	5
19	33	19	23	33	13		19.05	6
25		25					25.4	8
						06 (M0)	6	
						08 (M0)	8	
						10 (M0)	10	
						12 (M0)	12	
						16 (M0)	16	

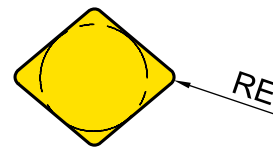
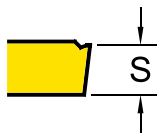

6 - Insert Thickness (S)

Metric	Thickness - S (mm)	Inch
T1	1.98	1.2
02	2.38	1.5
03	3.18	2
T3	3.97	2.5
04	4.76	3
05	5.56	3.5
06	6.35	4
07	7.94	5
09	9.525	6

7 - Corner Radius (RE)

Metric	Corner Radius - RE (mm)	Inch
01	0.1	03
02	0.2	05
04	0.4	1
08	0.8	2
12	1.2	3
16	1.6	4
20	2.0	5
24	2.4	6

Grade Naming System

TURNING

1 YG YG Brand	2 3 Workpiece Material	3 1 Grade Version	4 1 Application Range (1st Digit)	5 5 Application Range (2nd Digit)	(6) (G) Minor Variation
Carbide CVD (4 Digits)	●	●	●	●	YG3115
Carbide PVD (3 Digits)	●	●	●		YG211
Carbide Uncoated (2 Digits)	●	●			YG10

PARTING & GROOVING

1 - YG Brand

2 - Workpiece Material

Symbol	Workpiece Material	Turning	Milling	Drilling	Parting
1	K Cast Iron or N Non-Ferrous	●			
2	M Stainless Steel	●			
3	P Steel	●			
4	S Superalloys	●			
5	K Cast Iron or N Non-Ferrous		●	●	●
6	M Stainless Steel or Universal		●	●	●
7	P Steel		●	●	●
8	Universal	●			
0	Hardened Steel		●		

4 & 5 - Application Range

Symbol	Application Range
05	<p>Stable Wear Resistant Grade Stable Application Continuous Cut Finishing</p>
10	
15	
20	<p>General Balanced Grade High Versatility General Application</p>
25	
30	
35	<p>Unstable Tougher Grade Unstable Application Interrupted Cut Chipping Resistance Roughing</p>
40	
45	

3 - Grade Version

(6) - (Minor Variation)

G - Gold Coated Version

Product Overview

Turning Grades Map

Speed : Vc (m/min.)
Feed : Fn (mm/rev.)

TURNING
PARTING & GROOVING
MILLING
DRILLING
TECHNICAL INFORMATION

Steel

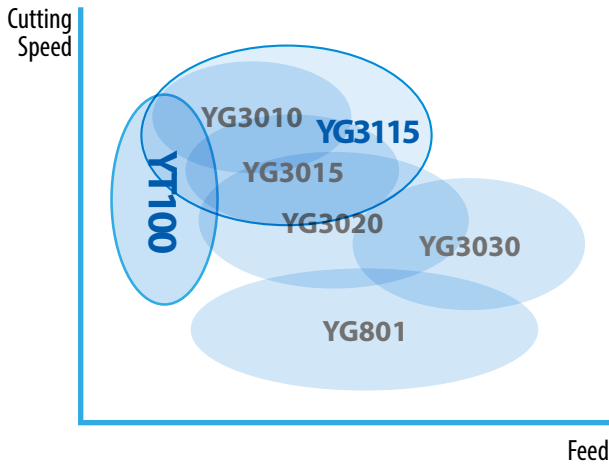

Stainless steel

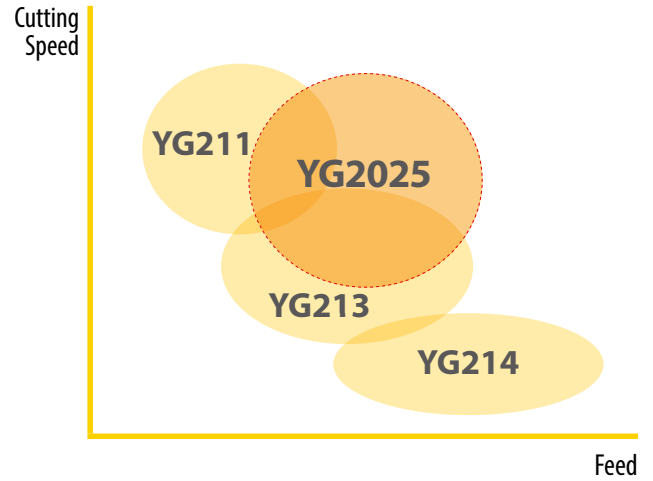

Cast iron

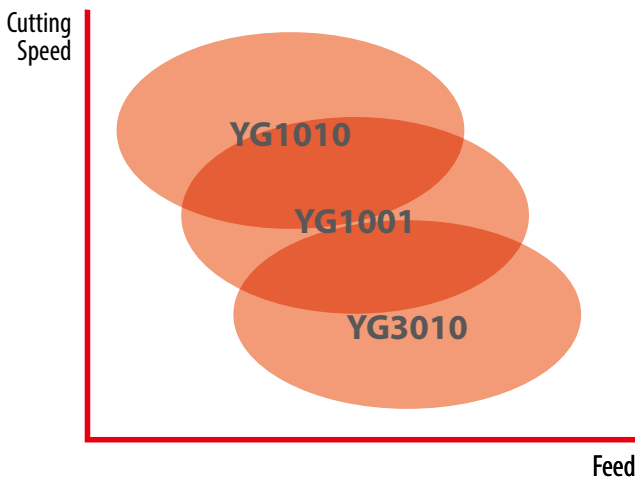

Non-ferrous Metal

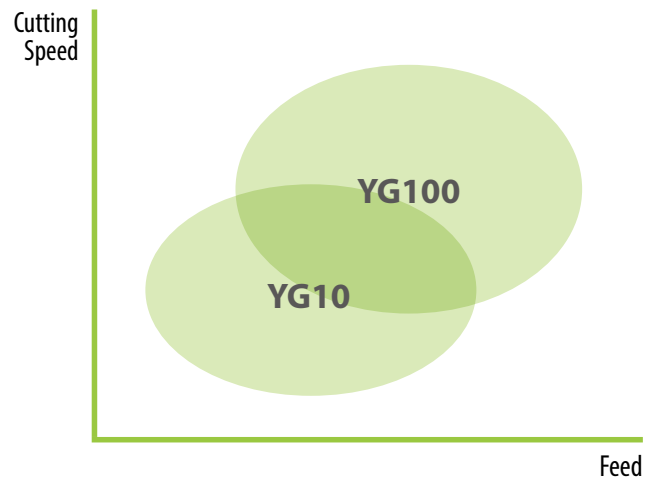

Superalloy

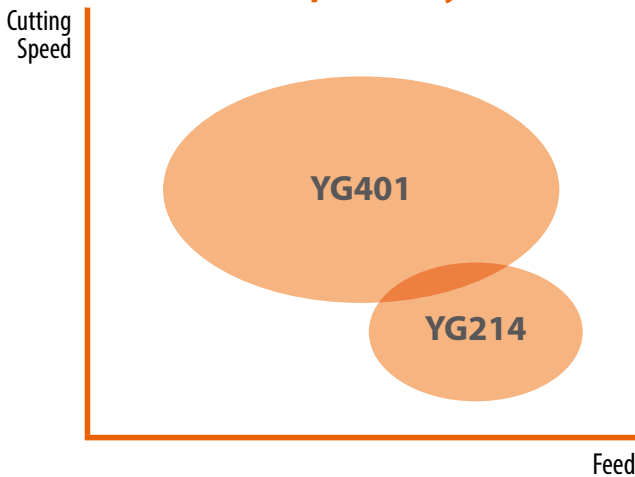

Turning Grades

TURNING
PARTING & GROOVING
MILLING
DRILLING

Turning Grades	P Steel				M Stainless steel			K Cast iron			N Non-ferrous		S Superalloys	
	P10	P20	P30	P40	M10	M20	M30	K10	K20	K30	N10	N20	S10	S20
CVD	YG1010							1010						
	YG1001	1001						1001						
	YG3010		3010						3010					
	YG3015		3015											
	YG3115		3115											
	YG3020		3020											
	YG3030		3030											
	YG2025					2025								
PVD	YG801	801												
	YG211					211								
	YG213					213								
	YG214					214							214	
	YG401												401	
Cermet	YT100	YT100				YT100		YT100						
DLC	YG100									100				
-	YG10									10				

TECHNICAL INFORMATION

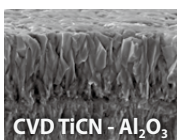
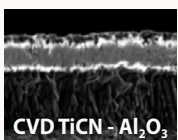
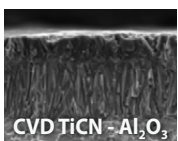
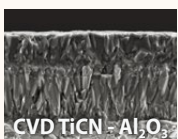
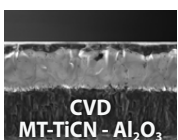
<p>YG1010</p> <p>K05 - K15</p>	 <p>CVD TiCN - Al₂O₃</p>	<p>First Choice for Cast Iron</p> <ul style="list-style-type: none"> • Effective coating structure enables high speed machining • Special post treatment for improved chipping resistance
<p>YG1001</p> <p>P01 - P10</p> <p>K10 - K25</p>	 <p>CVD TiCN - Al₂O₃</p>	<p>Stable Machining of Cast Iron</p> <ul style="list-style-type: none"> • Substrate especially designed for high wear resistance • Thick Al₂O₃ layer ensures good wear resistance at high cutting speeds including dry machining
<p>YG3010</p> <p>P05 - P20</p> <p>K15 - K35</p>	 <p>CVD TiCN - Al₂O₃</p>	<p>First choice for Finishing Steels, and Ductile Cast iron</p> <ul style="list-style-type: none"> • Finishing and light machining of steel under in stable condition • New Al₂O₃ coating technology and excellent surface smoothness increase wear resistance and chipping resistance
<p>YG3015</p> <p>P10 - P25</p>	 <p>CVD TiCN - Al₂O₃</p>	<p>Balanced Productivity for Continuous cut</p> <ul style="list-style-type: none"> • High wear resistance and improved toughness ensures high productivity with less trouble
<p>NEW</p> <p>YG3115</p> <p>P15 - P25</p>	 <p>CVD MT-TiCN - Al₂O₃</p>	<p>First choice grade for high cutting speed in Steels</p> <ul style="list-style-type: none"> • Suitable for mass production due to stable and predictable tool life • Minimizing built up edge due to new post surface treatment in mild steels, low carbon steel and low carbon alloy steel. • Best choice for both continuous as well as interrupted cuts

Product Overview

Turning Grades

<p>YG3020</p> <p>P15 - P30</p>	 <p>CVD TiCN - Al₂O₃</p>	<p>First Choice Grade for General Steel Application</p> <ul style="list-style-type: none"> • Substrate especially designed for good toughness • Excellent surface smoothness increases wear resistance and reliability
<p>YG3030</p> <p>P20 - P35</p>	 <p>CVD TiCN - Al₂O₃</p>	<p>Interrupted Cutting of Steel and Stainless steel</p> <ul style="list-style-type: none"> • Substrate for heavy roughing in mild steel and low carbon alloy steel • New Al₂O₃ technology and optimized surface treatment achieves a good balance between wear resistance and chipping resistance
<p>YG801</p> <p>P10 - P30</p>	 <p>PVD - TiAlN</p>	<p>for Carbon Steel with Low Cutting Speed</p> <ul style="list-style-type: none"> • Recommended for mild steel and boring application • Substrate and special PVD coating for excellent wear resistance
<p>NEW</p> <p>YG2025</p> <p>M15 - M35</p>	 <p>CVD TiCN - Al₂O₃</p>	<p>CVD grade for High Cutting Speed for Stainless steel</p> <ul style="list-style-type: none"> • Utilizing a new carbide substrate and new coating • Excellent combination of wear resistance and chipping resistance • Minimized built up edge due to post surface treatment
<p>YG211</p> <p>M05 - M25</p>	 <p>PVD - TiAlN</p>	<p>High wear Resistance Grade for Stainless steel</p> <ul style="list-style-type: none"> • Finishing Stainless steel
<p>YG213</p> <p>M20 - M35</p>	 <p>PVD - TiAlN</p>	<p>First Choice Grade on Low Cutting Speed of Stainless steel</p> <ul style="list-style-type: none"> • First choice on Stainless steel for Low cutting speed • For Medium to low cutting speed
<p>YG214</p> <p>M30 - M40</p> <p>S25 - S30</p>	 <p>PVD - TiAlN</p>	<p>Heavy Interrupted cut for Stainless steel</p> <ul style="list-style-type: none"> • For Heavy Interrupted cut on Stainless steel • Minimize risk of Mechanical fracture or Chipping
<p>YG401</p> <p>S10 - S20</p>	 <p>PVD - TiAlSiN</p>	<p>PVD Turning Grade for HRSA</p> <ul style="list-style-type: none"> • Highly heat-resistant TiAlSiN structure for excellent wear resistance • Greatly improved film coating realizes excellent boundary defect resistance • Top coating layer provides a smooth surface and lubricant effect
<p>NEW</p> <p>YT100</p> <p>P10 - P20</p> <p>M10 - M20</p> <p>K10 - K20</p>	 <p>Cermet</p>	<p>New Generation Cermet Grade</p> <ul style="list-style-type: none"> • Enhanced wear resistance & chipping resistance • Excellent fracture resistance • Superior surface finish with special edge preparation
<p>YG100</p> <p>N05 - N25</p>	 <p>DLC</p>	<p>First Choice Grade for Aluminum with DLC Coating</p> <ul style="list-style-type: none"> • Submicron carbide for high wear resistance • DLC coating minimizes Built Up Edge tendency. • Improve tool life in sticky non-ferrous alloy
<p>YG10</p> <p>N05 - N25</p>	 <p>Uncoated</p>	<p>Uncoated Grade for General Aluminum</p> <ul style="list-style-type: none"> • Substrate consisted of submicron carbide for high wear resistance • Shining surface to prevent built up edge

Turning Chipbreakers - Negative

	P	M	K	N	S		Feed	Fn (mm/rev.)						
								0	0.1	0.2	0.3	0.4	0.5	0.6
TURNING	P					UF	Finishing							
	P					UL	Semi Finishing and sticky materials							
	P					UM	Medium & Unstable conditions							
	P					UG	First Choice for Medium (Stable conditions)							
	PARTING & GROOVING	P					NEW PWM	Wiper-Medium						
		P					NEW UH	Low cutting force						
		P					NEW UT	Heavy roughing						
		P		K			UC	Medium Roughing and First choice for Cast iron						
	MILLING	P		K			UR	Roughing and Heavy interrupted cut						
		DRILLING					..MA	Cast iron Heavy Roughing						
TECHNICAL INFORMATION														

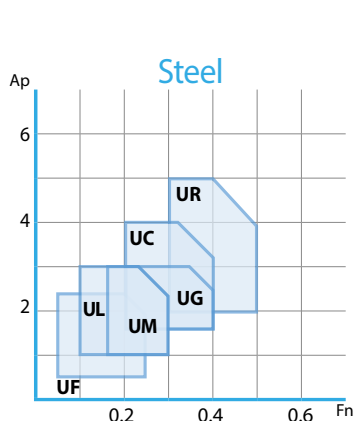

*Insert : CNMG120408

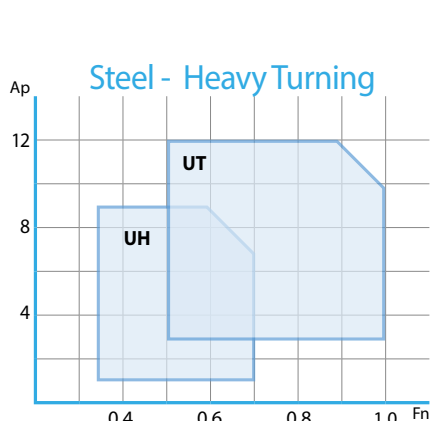

*Insert : CNMM190624

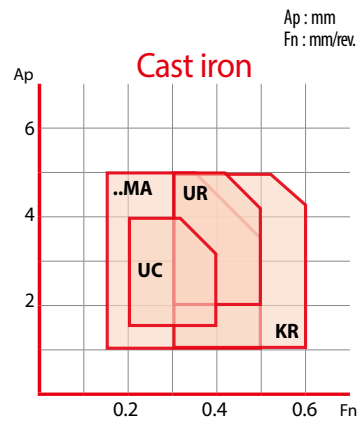

*Insert : CNMG120408

Product Overview

Turning Chipbreakers - Negative

P	M	K	N	S	Model	Application	Diagram	Feed						
								0	0.1	0.2	0.3	0.4	0.5	0.6
		K			KR	Cast Iron Heavy Roughing		<div style="background-color: #f4a460; padding: 5px; display: inline-block;">Fn 0.3~0.6</div> <div style="background-color: #808080; padding: 5px; display: inline-block;">Ap 1.0~5.0</div>						
	M			S	MF	Stainless steel Finishing		<div style="background-color: #f4a460; padding: 5px; display: inline-block;">Fn 0.07~0.30</div> <div style="background-color: #808080; padding: 5px; display: inline-block;">Ap 0.2~1.5</div>						
P	M			S	MM	Stainless steel Medium and Low Carbon Steel		<div style="background-color: #f4a460; padding: 5px; display: inline-block;">Fn 0.20~0.35</div> <div style="background-color: #808080; padding: 5px; display: inline-block;">Ap 1.0~3.5</div>						
	M			S	MG	Stainless steel General		<div style="background-color: #f4a460; padding: 5px; display: inline-block;">Fn 0.20~0.40</div> <div style="background-color: #808080; padding: 5px; display: inline-block;">Ap 1.0~4.0</div>						
	M			S	MR	Stainless steel Roughing		<div style="background-color: #f4a460; padding: 5px; display: inline-block;">Fn 0.30~0.55</div> <div style="background-color: #808080; padding: 5px; display: inline-block;">Ap 1.8~5.5</div>						
				S	SF	HRSA Finishing		<div style="background-color: #f4a460; padding: 5px; display: inline-block;">Fn 0.10~0.25</div> <div style="background-color: #808080; padding: 5px; display: inline-block;">Ap 0.2~1.0</div>						
				S	SM	HRSA Medium		<div style="background-color: #f4a460; padding: 5px; display: inline-block;">Fn 0.10~0.25</div> <div style="background-color: #808080; padding: 5px; display: inline-block;">Ap 0.5~3.0</div>						
				S	SR	Roughing for HRSA		<div style="background-color: #f4a460; padding: 5px; display: inline-block;">Fn 0.20~0.35</div> <div style="background-color: #808080; padding: 5px; display: inline-block;">Ap 1.0~4.5</div>						
P	M	K			NEW PSF	Cermet Finishing		<div style="background-color: #f4a460; padding: 5px; display: inline-block;">Fn 0.10~0.30</div> <div style="background-color: #808080; padding: 5px; display: inline-block;">Ap 0.5~3.0</div>						
P	M	K			NEW -C	Cermet Medium		<div style="background-color: #f4a460; padding: 5px; display: inline-block;">Fn 0.15~0.35</div> <div style="background-color: #808080; padding: 5px; display: inline-block;">Ap 1.0~3.5</div>						

TURNING
PARTING & GROOVING
MILLING
DRILLING
TECHNICAL INFORMATION

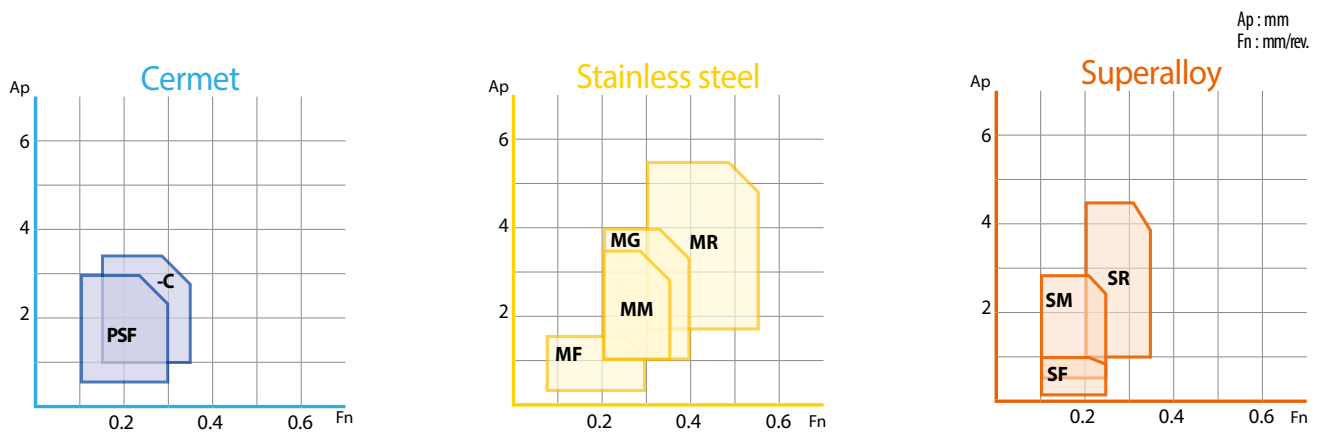

*Insert : CNMG120408 / TNGG160408

*Insert : CNMG120408

*Insert : CNMG120408

Turning Chipbreakers - Positive

TURNING

PARTING & GROOVING

MILLING

DRILLING

TECHNICAL INFORMATION

Material	Chip Breaker	Application	Diagram	Feed F _n (mm/rev.)					
				0	0.1	0.2	0.3	0.4	0.5
P M K N S		Aluminum application		Fn 0.05~0.40 Ap 0.5~5.0					
P M	UF	Finishing application		Fn 0.05~0.20 Ap 0.5~1.5					
P K	UG	Medium application		Fn 0.15~0.30 Ap 1.0~3.0					
M	NEW MF	Stainless steel Finishing		Fn 0.05~0.20 Ap 0.5~2.0					
M	NEW MM	Stainless steel Medium		Fn 0.10~0.30 Ap 0.5~3.0					
M	NEW SF	HRSA Finishing		Fn 0.02~0.15 Ap 0.1~1.5					
P M K	NEW PF	Cermet Finishing		Fn 0.05~0.20 Ap 0.5~2.0					
P M K	NEW PM	Cermet Medium		Fn 0.10~0.30 Ap 0.5~3.0					

Depth of Cut Ap (mm)

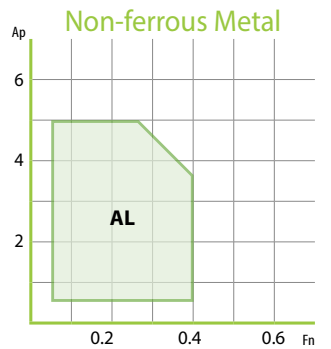
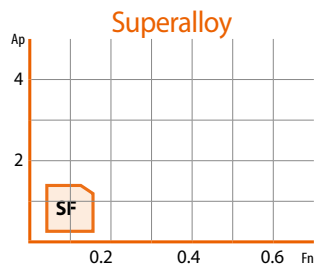
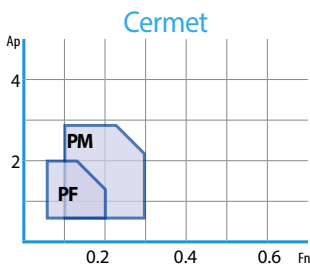
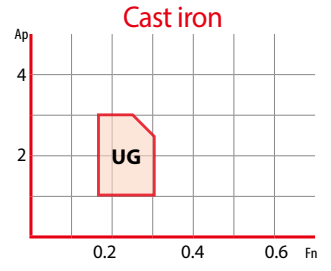
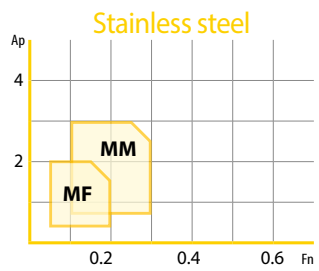
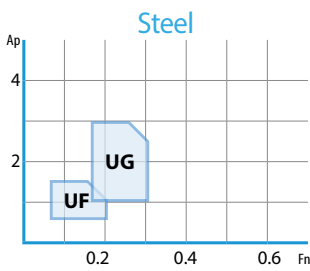









*Insert : CCMT09T308







Turning Inserts Overview

Negative Inserts

Recommended Cutting Conditions : p.222

Shape	Series	Size & Thickness										Page				
C		CNMA				1204				1606	1906					30
	CNMG	0903	0904		1204				1606	1906				2509		
	CNGG				1204											
	CNMM				1204				1606	1906				2509		
D		DNMA				1504	1506									35
	DNMG			1104		1504	1506									
	DNGG					1504	1506									
	DNMM						1506									
DNUX		DNMX				1504	1506									40
K		KNMX							1604							41
S		SNMA				1204	1506				1906					42
	SNMG	0903				1204					1906				2509	
	SNMM						1506				1906		2507	2509		
T		TNMA							1604							47
	TNMG								1604			2204				
	TNGG								1604							
TNUX		TNMX							1604							50
V		VNMA							1604							51
	VNMG								1604							
W		WNMA				0804										53
	WNMG		0604			0804										
	WNGG					0804										

Positive Inserts

Shape	Series	Size & Thickness										Page				
C		CCGT	0602			09T3				1204						57
	CCMT	0602				09T3				1204						
D		DCGT		0702						11T3						59
	DCMT		0702							11T3						
R		RCMT	0602		0803	10T3				1204						61
	RCMX												1606	2006		62
S		SCGT				09T3										63
	SCMT					09T3				1204						
T		TCGT						1102					16T3			64
	TCMT							1102					16T3			
V		VBGT / VBMT								1103			1604			66
	VCGT / VCMT									1103			1604			67



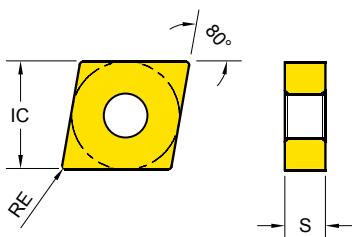

Turning Inserts - Negative CNMA / CNMG (80° Rhombic)



Series	IC	S
CN** 0903	9.525	3.18
CN** 0904	9.525	4.76
CN** 1204	12.700	4.76
CN** 1606	15.875	6.35
CN** 1906	19.050	6.35

EDP 2200..

● : Stock item ○ : Order made item

CNMA CNMG	Designation	RE	Fn (mm/rev.)	Ap (mm)	K10	P05	P10	P15	P10	P20	P30	P20	M25	M15	M30	M40	S10	P15	M15	N20	N20			
					YG1010	YG1001	YG3010	YG3015	YG3115	YG3020	YG3030	YG801	YG2025	YG211	YG213	YG214	YG401	YT100	YG100	YG10				
..MA  Cast iron	CNMA 120404	0.4	0.15~0.50	0.5~5.0	●	○	○																	
	CNMA 120408	0.8	0.15~0.50	1.0~5.0	●	○	○																	
	CNMA 120412	1.2	0.15~0.50	1.5~5.0	●	○	○																	
	CNMA 120416	1.6	0.15~0.50	2.0~5.0	●	○	○																	
	CNMA 160612	1.2	0.15~0.50	1.5~5.0	●	○	○																	
	CNMA 160616	1.6	0.15~0.50	2.0~5.0	●	○	○																	
	CNMA 190612	1.2	0.15~0.50	1.5~9.0	●	○	○																	
	CNMA 190616	1.6	0.15~1.00	3.0~10.0	●	○	○																	
-UF  Finishing	CNMG 120404 - UF	0.4	0.05~0.25	0.5~2.5			○			●	●	●	○											
	CNMG 120408 - UF	0.8	0.05~0.25	1.0~2.5			○			●	●	●												
	CNMG 120412 - UF	1.2	0.05~0.25	1.5~2.5			○			●	●	●												
-UL  Light Machining and Sticky Material	CNMG 090308 - UL	0.8	0.10~0.30	1.0~2.5			○			●	●	●												
	CNMG 090312 - UL	1.2	0.10~0.30	1.5~2.5			○			●	●	●												
	CNMG 090408 - UL	0.8	0.10~0.30	1.0~2.5			○			●	●	●												
	CNMG 090412 - UL	1.2	0.10~0.30	1.5~2.5			○			●	●	●												
	CNMG 120404 - UL	0.4	0.10~0.30	0.5~3.0			○			●	●	●												
	CNMG 120408 - UL	0.8	0.10~0.30	1.0~3.0			○			●	●	●												
	CNMG 120412 - UL	1.2	0.10~0.30	1.5~3.0			○			●	●	●												
	CNMG 120404 - UM	0.4	0.15~0.30	0.5~3.0			●			○	●	●												
-UM  Medium Machining Unstable condition	CNMG 120408 - UM	0.8	0.15~0.30	1.0~3.0	●	●	●	○		●	●													
	CNMG 120412 - UM	1.2	0.15~0.30	1.5~3.0	●	●	●			●	●													



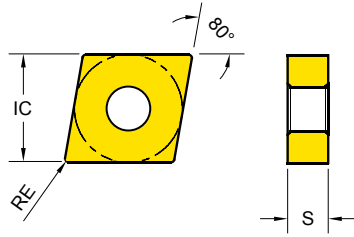

Turning Inserts - Negative CNMG (80° Rhombic)



Series	IC	S
CN** 0903	9.525	3.18
CN** 0904	9.525	4.76
CN** 1204	12.700	4.76
CN** 1606	15.875	6.35
CN** 1906	19.050	6.35

EDP 2200..

● : Stock item ○ : Order made item

CNMG	Designation	RE	Fn (mm/rev.)	Ap (mm)	K10	P05	P10	P15	P10	P20	P30	P20	M25	M15	M30	M40	S10	P15	M15	N20	N20		
					YG1010	YG1001	YG3010	YG3015	YG3115	YG3020	YG3030	YG801	YG2025	YG211	YG213	YG214	YG401	YT100	YG100	YG10			
-UG  Medium Machining at stable condition	CNMG 120404-UG	0.4	0.20~0.40	0.5~3.0	●	○	○		●	●	●												
	CNMG 120408-UG	0.8	0.20~0.40	1.0~3.0	●	○	○	○	●	●	●	○											
	CNMG 120412-UG	1.2	0.20~0.40	1.5~3.0	●	○	○		●	●	●												
	CNMG 160608-UG	0.8	0.20~0.40	1.0~5.0	●	○	○		●	●	●												
	CNMG 160612-UG	1.2	0.20~0.40	1.5~5.0	●	○	○		●	●	●												
	CNMG 160616-UG	1.6	0.30~0.50	2.0~5.0	●	○	○		●	●	●												
	CNMG 190608-UG	0.8	0.20~0.60	1.0~6.0	●		○		●	●	●												
	CNMG 190612-UG	1.2	0.20~0.60	1.5~6.0					●	●	●												
NEW -PWM  Wiper-Medium	CNMG 120404-PWM	0.4	0.10~0.50	0.5~3.5	●				●	●	○												
	CNMG 120408-PWM	0.8	0.10~0.50	0.8~3.5	●				●	●	●												
	CNMG 120412-PWM	1.2	0.10~0.50	1.0~3.5	●				●	●	●												
-UC  Cast iron and Medium roughing	CNMG 120404-UC	0.4	0.20~0.40	0.5~4.0	●	○	○		●	●	●												
	CNMG 120408-UC	0.8	0.20~0.40	1.0~4.0	●	○	○		●	●	●												
	CNMG 120412-UC	1.2	0.20~0.40	1.5~4.0	●	○	○		●	●	●												
-UR  Roughing	CNMG 120408-UR	0.8	0.30~0.50	1.0~5.0	●	○	○		●	●	●												
	CNMG 120412-UR	1.2	0.30~0.50	1.5~5.0	●	○	○		●	●	●	○											
	CNMG 120416-UR	1.6	0.30~0.50	2.0~5.0	●	○	○		●	●	●												
	CNMG 160608-UR	0.8	0.30~0.50	1.0~5.0	●	○	○		●	●	●												
	CNMG 160612-UR	1.2	0.30~0.50	1.5~5.0	●	○	○		●	●	●												
	CNMG 160616-UR	1.6	0.30~0.50	2.0~5.0	●	○	○		●	●	●												
	CNMG 190608-UR	0.8	0.30~0.80	3.0~9.0	●		○		●	●	●												
	CNMG 190612-UR	1.2	0.30~0.80	3.0~9.0	●	○	○		●	●	●												
	CNMG 190616-UR	1.6	0.30~0.80	3.0~9.0	●	○	○		●	●	●												
-KR  Cast Iron Heavy Roughing	CNMG 120408-KR	0.8	0.30~0.60	1.0~5.0	●	○	○		●	●	●												
	CNMG 120412-KR	1.2	0.30~0.60	1.5~5.0	●	○	○		●	●	●												
	CNMG 160612-KR	1.2	0.30~0.60	1.5~6.0	●		○		●	●	●												
	CNMG 160616-KR	1.6	0.30~0.60	2.0~6.0	●		○		●	●	●												
	CNMG 190612-KR	1.2	0.30~1.00	3.0~9.0	●				●	●	●												



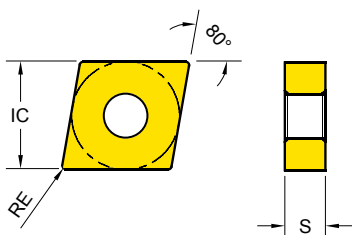

Turning Inserts - Negative CNMG (80° Rhombic)



Series	IC	S
CN** 0903	9.525	3.18
CN** 0904	9.525	4.76
CN** 1204	12.700	4.76
CN** 1606	15.875	6.35
CN** 1906	19.050	6.35

EDP 2200..

● : Stock item ○ : Order made item

CNMG	Designation	RE	Fn (mm/rev.)	Ap (mm)	K10	P05	P10	P15	P10	P20	P30	P20	M25	M15	M30	M40	S10	P15	M15	N20	N20		
					YG1010	YG1001	YG3010	YG3015	YG3115	YG3020	YG3030	YG801	YG2025	YG211	YG213	YG214	YG401	YT100	YG100	YG10	K20	K30	K15
-MF  Stainless steel Finishing	CNMG 120404 - MF	0.4	0.07~0.3	0.2~1.5																			
	CNMG 120408 - MF	0.8	0.07~0.3	0.2~1.5																			
	CNMG 120412 - MF	1.2	0.07~0.3	0.2~1.5																			
-MM  Stainless steel Medium	CNMG 120404 - MM	0.4	0.20~0.35	0.5~3.5																			
	CNMG 120408 - MM	0.8	0.20~0.35	1.0~3.5																			
	CNMG 120412 - MM	1.2	0.20~0.35	1.5~3.5																			
	CNMG 190608 - MM	0.8	0.20~0.50	2.0~5.5																			
	CNMG 190612 - MM	1.2	0.20~0.55	2.0~5.5																			
-MG  Stainless steel General	CNMG120404 - MG	0.4	0.20~0.40	0.5~4.0																			
	CNMG 120408 - MG	0.8	0.20~0.40	1.0~4.0																			
	CNMG 120412 - MG	1.2	0.20~0.40	1.5~4.0																			
	CNMG 160608 - MG	0.8	0.20~0.45	1.0~4.0																			
	CNMG 160612 - MG	1.2	0.20~0.50	2.0~4.0																			
	CNMG 160616 - MG	1.6	0.20~0.50	2.0~4.0																			
	CNMG 190616 - MG	1.6	0.20~0.50	2.0~5.0																			
-MR  Stainless steel Roughing	CNMG 120408 - MR	0.8	0.30~0.55	2.0~5.5																			
	CNMG 120412 - MR	1.2	0.30~0.55	2.0~5.5																			
	CNMG 120416 - MR	1.6	0.30~0.55	2.0~5.5																			

TURNING

PARTING & GROOVING

MILLING

DRILLING

TECHNICAL INFORMATION

Turning Inserts - Negative



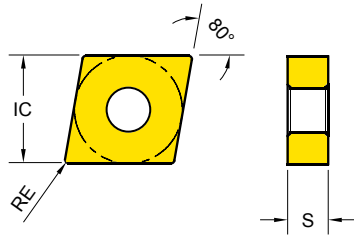

CNGG / CNMG (80° Rhombic)



Series	IC	S
CN** 0903	9.525	3.18
CN** 0904	9.525	4.76
CN** 1204	12.700	4.76
CN** 1606	15.875	6.35
CN** 1906	19.050	6.35

EDP 2200..

● : Stock item ○ : Order made item

CNGG CNMG	Designation	RE	Fn (mm/rev.)	Ap (mm)	K10	P05 K20	P10 K30	P15	P10	P20	P30	P20	M25	M15	M30	M40 S30	S10	P15 M15 K15	N20	N20
					YG1010	YG1001	YG3010	YG3015	YG3115	YG3020	YG3030	YG801	YG2025	YG211	YG213	YG214	YG401	YT100	YG100	YG10
- SF  HRSA Finishing	CNGG 120401 - SF	0.1	0.05 ~ 0.30	0.1 ~ 3.0														●		
	CNGG 120402 - SF	0.2	0.10 ~ 0.30	0.1 ~ 0.3														●		
	CNGG 120404 - SF	0.4	0.10 ~ 0.30	0.2 ~ 0.3														●		
	CNGG 120408 - SF	0.8	0.10 ~ 0.30	0.2 ~ 0.3														●		
- SM  HRSA Medium	CNMG 120408 - SM	0.8	0.10 ~ 0.25	0.5 ~ 4.0									○	○	○	○	●			
	CNMG 120412 - SM	1.2	0.10 ~ 0.25	0.5 ~ 4.0									○	○	○	○	●			
- SR  HRSA Roughing	CNMG 120408 - SR	0.8	0.10 ~ 0.40	0.5 ~ 4.0													●			
	CNMG 120412 - SR	1.2	0.10 ~ 0.40	0.5 ~ 4.0													●			
	CNMG 120416 - SR	1.6	0.10 ~ 0.40	0.5 ~ 4.0													●			
NEW - PSF  Cermet Finishing	CNMG 120404 - PSF	0.4	0.07 ~ 0.30	0.4 ~ 3.0														●		
	CNMG 120408 - PSF	0.8	0.10 ~ 0.30	0.6 ~ 3.0														●		

TURNING

PARTING & GROOVING

MILLING

DRILLING

TECHNICAL INFORMATION

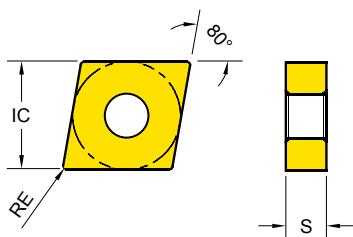

Turning Inserts - Negative CNMG / CNMM - Heavy Turning (80° Rhombic)



Series	IC	S
CN** 1204	12.700	4.76
CN** 1606	15.875	6.35
CN** 1906	19.050	6.35
CN** 2509	25.400	9.52

EDP 2200..

● : Stock item ○ : Order made item

CNMG CNMM	Designation	RE	Fn (mm/rev.)	Ap (mm)	K10	P05	P10	P15	P10	P20	P30	P20	M25	M15	M30	M40	S10	P15	M15	N20	N20		
					K20	K30	YG1001	YG3010	YG3015	YG3115	YG3020	YG3030	YG801	YG2025	YG211	YG213	YG214	YG401	YT100	YG100	YG10		
 <p>- UH Low cutting force</p>	CNMM 120408 - UH	0.8	0.30~0.50	1.5~5.0																			
	CNMM 160612 - UH	1.2	0.35~0.60	2.0~5.5																			
	CNMM 160616 - UH	1.6	0.35~0.60	2.5~5.5																			
	CNMM 190612 - UH	1.2	0.35~0.70	1.5~9.0	●	●																	
	CNMM 190616 - UH	1.6	0.35~0.70	2.0~9.0	●	●																	
	CNMM 190624 - UH	2.4	0.35~0.70	3.0~9.0	●	●																	
	CNMM 250924 - UH	2.4	0.40~0.80	3.0~10.0	●	●																	
 <p>- UR Heavy General</p>	CNMM 190616 - UR	1.6	0.30~0.80	3.0~9.0																			
	CNMG 250924 - UR	2.4	0.40~1.00	5.0~12.0																			
 <p>- UT Heavy Roughing</p>	CNMM 120408 - UT	0.8	0.40~0.70	1.5~6.0																			
	CNMM 160612 - UT	1.2	0.45~0.70	2.0~6.0																			
	CNMM 160616 - UT	1.6	0.45~0.70	2.5~6.0																			
	CNMM 190612 - UT	1.2	0.50~1.00	3.0~12.0	●	●																	
	CNMM 190616 - UT	1.6	0.50~1.00	4.0~12.0	●	●																	
	CNMM 190624 - UT	2.4	0.50~1.00	6.0~12.0	●	●																	
	CNMM 250924 - UT	2.4	0.55~1.20	6.0~13.0	●	●																	

Turning Inserts - Negative

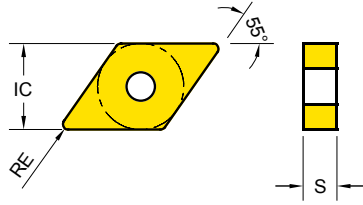

DNMA / DNMG (55° Rhombic)



Series	IC	S
DN** 1104	9.525	4.76
DN** 1504	12.700	4.76
DN** 1506	12.700	6.35

EDP 2200..

● : Stock item ○ : Order made item

DNMA DNMG	Designation	RE	Fn (mm/rev.)	Ap (mm)	K10	P05	P10	P15	P10	P20	P30	P20	M25	M15	M30	M40	S10	P15	M15	N20	N20		
					YG1010	YG1001	YG3010	YG3015	YG3115	YG3020	YG3030	YG801	YG2025	YG211	YG213	YG214	YG401	YT100	YG100	YG10			
..MA  Cast iron	DNMA 150404	0.4	0.10~0.50	0.5~5.0	●	○	○																
	DNMA 150408	0.8	0.15~0.50	1.0~5.0	●	○	○																
	DNMA 150412	1.2	0.15~0.50	1.5~5.0	●	○	○																
	DNMA 150604	0.4	0.10~0.50	1.0~5.0	●	○	○																
	DNMA 150608	0.8	0.15~0.50	1.0~5.0	●	○	○																
	DNMA 150612	1.2	0.15~0.50	1.5~5.0	●	○	○																
-UF  Finishing	DNMG 150404 - UF	0.4	0.05~0.25	0.5~2.5		○			●	●	●	○											
	DNMG 150408 - UF	0.8	0.05~0.25	1.0~2.5		○	○		●	●	●												
	DNMG 150412 - UF	1.2	0.05~0.25	1.5~2.5		○			●	●	●												
	DNMG 150604 - UF	0.4	0.05~0.25	1.0~2.0		○			●	●	●	○											
	DNMG 150608 - UF	0.8	0.05~0.25	1.5~3.5		○			●	●	●												
	DNMG 150612 - UF	1.2	0.05~0.25	1.5~2.5		○			●	●	●												
-UL  Light Machining and Sticky Material	DNMG 110404 - UL	0.4	0.10~0.3	0.5~2.5		○			●	●	●												
	DNMG 110408 - UL	0.8	0.10~0.3	1.0~2.5		○			●	●	●												
	DNMG 150404 - UL	0.4	0.10~0.3	0.5~3.0		○			●	●	●												
	DNMG 150408 - UL	0.8	0.10~0.3	1.0~3.0		○	○		●	●	●												
	DNMG 150412 - UL	1.2	0.10~0.3	1.5~3.0		○	○		●	●	●												
	DNMG 150604 - UL	0.4	0.10~0.3	0.5~3.0		○			●	●	●												
	DNMG 150608 - UL	0.8	0.10~0.3	1.5~3.0		○			●	●	●												
	DNMG 150612 - UL	1.2	0.10~0.3	1.5~3.0		○			●	●	●												

Turning Inserts - Negative DNMG (55° Rhombic)

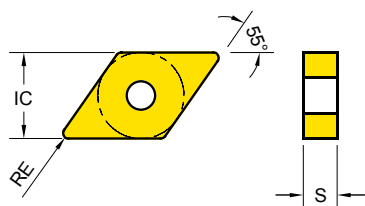

Series	IC	S
DN** 1104	9.525	4.76
DN** 1504	12.700	4.76
DN** 1506	12.700	6.35





TURNING

PARTING & GROOVING

MILLING

DRILLING

TECHNICAL INFORMATION

DNMG	Designation	RE	Fn (mm/rev.)	Ap (mm)	EDP 2200..																	
					K10		P05	P10	P15	P10	P20	P30	P20	M25	M15	M30	M40	S10	P15	M15	N20	N20
					YG1010	YG1001	K20	K30	YG3010	YG3015	YG3115	YG3020	YG3030	YG801	YG2025	YG211	YG213	YG214	YG401	YT100	YG100	YG10
-UM  Medium Machining Unstable condition	DNMG 150404 - UM	0.4	0.15 ~ 0.30	0.5 ~ 3.0	○	○				●	●	●										
	DNMG 150408 - UM	0.8	0.15 ~ 0.30	1.0 ~ 3.0		○	○			●	●	●										
	DNMG 150412 - UM	1.2	0.15 ~ 0.30	1.5 ~ 3.0		○	○			●	●	●										
	DNMG 150604 - UM	0.4	0.15 ~ 0.30	0.5 ~ 3.0		○	○			●	●	●										
	DNMG 150608 - UM	0.8	0.15 ~ 0.30	1.0 ~ 3.0		○	○			●	●	●										
	DNMG 150612 - UM	1.2	0.15 ~ 0.30	1.5 ~ 3.0		○	○			●	●	●										
-UG  Medium Machining at stable condition	DNMG 150404 - UG	0.4	0.20 ~ 0.40	0.5 ~ 3.0	●	○				●	●	●										
	DNMG 150408 - UG	0.8	0.20 ~ 0.40	1.0 ~ 3.0	●	○	○			●	●	●	○									
	DNMG 150412 - UG	1.2	0.20 ~ 0.40	1.5 ~ 3.0	●	○	○			●	●	●	○									
	DNMG 150604 - UG	0.4	0.20 ~ 0.40	0.5 ~ 3.0	●	○	○			●	●	●	○									
	DNMG 150608 - UG	0.8	0.20 ~ 0.40	1.0 ~ 3.0	●	○	○			●	●	●	○									
	DNMG 150612 - UG	1.2	0.20 ~ 0.40	1.5 ~ 3.0	●	○	○			●	●	●	○									
-UC  Cast iron and Medium roughing	DNMG 150408 - UC	0.8	0.20 ~ 0.40	1.0 ~ 4.0	●	○	○	○	●	●	●											
	DNMG 150412 - UC	1.2	0.20 ~ 0.40	1.5 ~ 4.0	●	○	○		●	●	●											
	DNMG 150608 - UC	0.8	0.20 ~ 0.40	1.0 ~ 4.0	●	○	○	○	●	●	●											
	DNMG 150612 - UC	1.2	0.20 ~ 0.40	1.5 ~ 4.0	●	○	○		●	●	●											
-UR  Roughing	DNMG 150408 - UR	0.8	0.30 ~ 0.50	1.0 ~ 5.0	●	○	○		●	●	●											
	DNMG 150412 - UR	1.2	0.30 ~ 0.50	1.5 ~ 5.0	●	○	○		●	●	●											
	DNMG 150608 - UR	0.8	0.30 ~ 0.50	1.0 ~ 5.0	●	○	○		●	●	●											
	DNMG 150612 - UR	1.2	0.30 ~ 0.50	1.5 ~ 5.0	●	○	○		●	●	●	○										



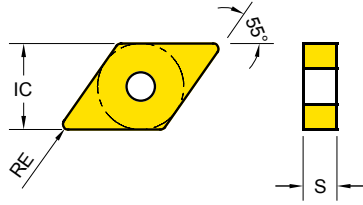

Turning Inserts - Negative DNMG (55° Rhombic)



Series	IC	S
DN** 1104	9.525	4.76
DN** 1504	12.700	4.76
DN** 1506	12.700	6.35

EDP 2200..

● : Stock item ○ : Order made item



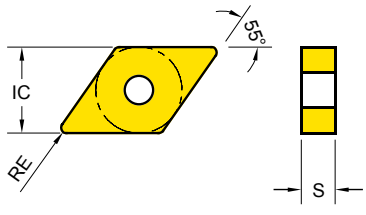

DNMG	Designation	RE	Fn (mm/rev.)	Ap (mm)	K10	P05	P10	P15	P10	P20	P30	P20	M25	M15	M30	M40	S10	P15	M15	N20	N20	
					YG1010	YG1001	YG3010	YG3015	YG3115	YG3020	YG3030	YG801	YG2025	YG211	YG213	YG214	YG401	YT100	YG100	YG10		
-MF  Stainless steel Finishing	DNMG 150404 - MF	0.4	0.07 ~ 0.30	0.2 ~ 1.5										●	●	●	●	○				
	DNMG 150408 - MF	0.8	0.07 ~ 0.30	0.2 ~ 1.5							○	0807		●	●	●	●	○				
	DNMG 150604 - MF	0.4	0.07 ~ 0.30	0.2 ~ 1.5										●	●	●	●	○				
	DNMG 150608 - MF	0.8	0.07 ~ 0.30	0.2 ~ 1.5							○	1202	○	0813	●	●	●	○				
-MM  Stainless steel Medium	DNMG 150404 - MM	0.4	0.20 ~ 0.35	0.5 ~ 3.5								○	0527	●	●	●	○					
	DNMG 150408 - MM	0.8	0.20 ~ 0.35	1.0 ~ 3.5								○	0506	●	●	●	○					
	DNMG 150412 - MM	1.2	0.20 ~ 0.35	1.5 ~ 3.5								○	0529	●	●	●	○					
	DNMG 150604 - MM	0.4	0.20 ~ 0.35	0.5 ~ 3.5								○	0528	●	●	●	○					
	DNMG 150608 - MM	0.8	0.20 ~ 0.35	1.0 ~ 3.5								○	0507	●	●	●	○					
	DNMG 150612 - MM	1.2	0.20 ~ 0.35	1.5 ~ 3.5								○	0496	●	●	●	○					
-MG  Stainless steel General	DNMG 150404 - MG	0.4	0.20 ~ 0.40	0.5 ~ 4.0										●								
	DNMG 150408 - MG	0.8	0.20 ~ 0.40	1.0 ~ 4.0										●	●	●	●					
	DNMG 150412 - MG	1.2	0.20 ~ 0.40	1.5 ~ 4.0										●								
	DNMG 150604 - MG	0.4	0.20 ~ 0.40	0.5 ~ 4.0										●								
	DNMG 150608 - MG	0.8	0.20 ~ 0.40	1.0 ~ 4.0										●	●	●	●					
	DNMG 150612 - MG	1.2	0.20 ~ 0.40	1.5 ~ 4.0										●								
-MR  Stainless steel Roughing	DNMG 150408 - MR	0.8	0.30 ~ 0.55	2.0 ~ 5.5							○	1036	●	●	●	●						
	DNMG 150412 - MR	1.2	0.30 ~ 0.55	2.0 ~ 5.5										●	●	●	○					
	DNMG 150608 - MR	0.8	0.30 ~ 0.55	2.0 ~ 5.5								○	1037	●	●	●	●					
	DNMG 150612 - MR	1.2	0.30 ~ 0.55	2.0 ~ 5.5										●	●	●	○					

Turning Inserts - Negative
DNGG / DNMG (55° Rhombic)



Series	IC	S
DN** 1104	9.525	4.76
DN** 1504	12.700	4.76
DN** 1506	12.700	6.35

EDP 2200.. ●: Stock item ○: Order made item

DNGG DNMG	Designation	RE	Fn (mm/rev.)	Ap (mm)	K10	P05 K20	P10 K30	P15	P10	P20	P30	P20	M25	M15	M30	M40 S30	S10	P15 M15 K15	N20	N20	
					YG1010	YG1001	YG3010	YG3015	YG3115	YG3020	YG3030	YG801	YG2025	YG211	YG213	YG214	YG401	YT100	YG100	YG10	
-SF  HRSA Finishing	DNGG 150404 - SF	0.4	0.10~0.30	0.2~3.0														●			
	DNGG 150408 - SF	0.8	0.10~0.30	0.5~3.0															●		
	DNGG 150604 - SF	0.4	0.10~0.30	0.2~3.0															●		
	DNGG 150608 - SF	0.8	0.10~0.30	0.5~3.0															●		
-SM  HRSA Medium	DNMG 150408 - SM	0.8	0.10~0.25	0.5~4.0												○	○	○	●		
	DNMG 150412 - SM	1.2	0.10~0.25	0.5~4.0												○	○	○	●		
	DNMG 150608 - SM	0.8	0.10~0.25	0.5~4.0												○	○	○	●		
	DNMG 150612 - SM	1.2	0.10~0.25	0.5~4.0												○	○	○	●		
-SR  HRSA Roughing	DNMG 150408 - SR	0.8	0.10~0.40	0.5~4.0															●		
	DNMG 150412 - SR	1.2	0.10~0.40	0.5~4.0															●		
	DNMG 150608 - SR	0.8	0.10~0.40	0.5~4.0															●		
	DNMG 150612 - SR	1.2	0.10~0.40	0.5~4.0															●		
NEW -PSF  Cermet Finishing	DNMG 150404 - PSF	0.4	0.07~0.30	0.4~3.0															●		
	DNMG 150408 - PSF	0.8	0.10~0.30	0.6~3.0															●		

TURNING

PARTING & GROOVING

MILLING

DRILLING

TECHNICAL INFORMATION

Turning Inserts - Negative

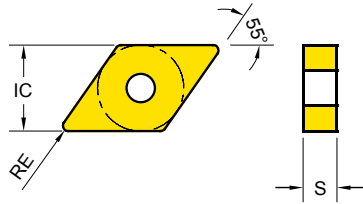

DNMM - Heavy Turning (55° Rhombic)



Series	IC	S
DN** 1104	9.525	4.76
DN** 1504	12.700	4.76
DN** 1506	12.700	6.35

EDP 2200..

● : Stock item ○ : Order made item

DNMM	Designation	RE	Fn (mm/rev.)	Ap (mm)	K10	P05	P10	P15	P10	P20	P30	P20	M25	M15	M30	M40	S10	P15	M15	N20	N20	
					YG1010	YG1001	YG3010	YG3015	YG3115	YG3020	YG3030	YG801	YG2025	YG211	YG213	YG214	YG401	YT100	YG100	YG10		
NEW -UH  Low cutting force	DNMM 150612 - UH	1.2	0.30~0.50	2.0~7.0																		
										●	●											
											2327	2328										
NEW -UT  Heavy Roughing	DNMM 150612 - UT	1.2	0.30~0.50	2.0~7.0																		
											●	●										
										2329	2330											

Turning Inserts - Negative DNUX (55° Rhombic)

Series	IC	S
DNUX 1504	12.7	4.76
DNUX 1506	12.7	6.35

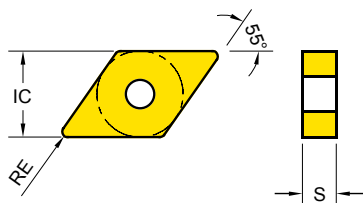

TURNING

PARTING & GROOVING



MILLING

DRILLING

TECHNICAL INFORMATION

EDP 2200..

● : Stock item ○ : Order made item

DNUX	Designation	RE	Fn (mm/rev.)	Ap (mm)	K10	P05	P10	P15	P10	P20	P30	P20	M25	M15	M30	M40	S10	P15	M15	N20	N20		
					YG1010	K20	K30	YG3010	YG3015	YG3115	YG3020	YG3030	YG801	YG2025	YG211	YG213	YG214	YG401	YT100	YG100	YG10		
 <p>NEW ..UX Left Hand Shown</p>	DNUX 150404 L	0.4	0.10~0.35	0.7~4.0			○	●	●	●													
	DNUX 150408 L	0.8	0.10~0.35	1.0~4.0			○	●	●	●													
	DNUX 150604 L	0.4	0.10~0.35	0.7~4.0			○	●	●	●								●	●				
	DNUX 150608 L	0.8	0.10~0.35	1.0~4.0			○	●	●	●								●	●				
 <p>NEW ..UX Right Hand Shown</p>	DNUX 150404 R	0.4	0.10~0.35	0.7~4.0			●	●	●	●													
	DNUX 150408 R	0.8	0.10~0.35	1.0~4.0			●	●	●	●													
	DNUX 150604 R	0.4	0.10~0.35	0.7~4.0			●	●	●	●											●		
	DNUX 150608 R	0.8	0.10~0.35	1.0~4.0			●	●	●	●								●	●				

Turning Inserts - Negative

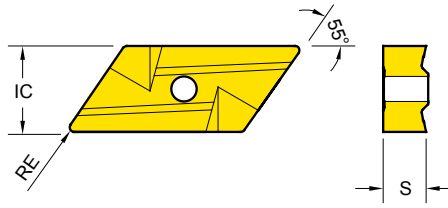

KNUX (55° - 2 Corners Rhombic)



Series	IC	S
KN** 1604	9.525	4.76

EDP 2200..

● : Stock item ○ : Order made item

KNUX	Designation	RE	Fn (mm/rev.)	Ap (mm)	K10	P05	P10	P15	P10	P20	P30	P20	M25	M15	M30	M40	S10	P15	M15	N20	N20	
					YG1010	YG1001	YG3010	YG3015	YG3115	YG3020	YG3030	YG801	YG2025	YG211	YG213	YG214	YG401	YT100	YG100	YG10		
..UX  Left Hand Shown	KNUX 160405 L	0.5	0.10~0.40	0.5~6.0			●															
	KNUX 160410 L	1.0	0.30~0.60	1.0~6.0			●															
..UX  Right Hand Shown	KNUX 160405 R	0.5	0.10~0.40	0.5~6.0			○															
	KNUX 160410 R	1.0	0.30~0.60	1.0~6.0			○															

Turning Inserts - Negative SNMA / SNMG (90° Square)

TURNING

PARTING & GROOVING

MILLING

DRILLING



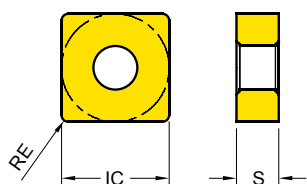

TECHNICAL INFORMATION



Series	IC	S
SN** 0903	9.525	3.18
SN** 1204	12.700	4.76
SN** 1506	15.875	6.35
SN** 1906	19.050	6.35

EDP 2200..

● : Stock item ○ : Order made item

SNMA SNMG	Designation	RE	Fn (mm/rev.)	Ap (mm)	K10	P05	P10	P15	P10	P20	P30	P20	M25	M15	M30	M40	S10	P15	M15	N20	N20	
					YG1010	YG1001	YG3010	YG3015	YG3115	YG3020	YG3030	YG801	YG2025	YG211	YG213	YG214	YG401	YT100	YG100	YG10		
..MA  Cast iron	SNMA 120408	0.8	0.15~0.50	1.0~5.0	● 0767	○ 0027	○ 1166															
	SNMA 120412	1.2	0.15~0.50	1.5~5.0	● 0768	○ 0028	○ 1133															
	SNMA 120416	1.2	0.15~0.70	1.0~6.0	● 2023																	
	SNMA 150612	1.2	0.15~0.50	1.5~5.0	● 1423	○ 0729	○ 1150															
	SNMA 190616	1.6	0.15~1.00	3.0~10.0	● 1344	○ 1184	○ 1261															
-UF  Finishing	SNMG 090308 - UF	0.8	0.05~0.20	1.0~2.0						● 2630	● 0999											
	SNMG 120404 - UF	0.4	0.05~0.25	0.5~1.5		○ 1458			● 2631	● 1459	● 1454	○ 0029										
	SNMG 120408 - UF	0.8	0.05~0.25	1.0~2.5		○ 1430			● 2633	● 1433	● 1437											
-UL  Light Machining and Sticky Material	SNMG 120404 - UL	0.4	0.10~0.30	0.5~3.0		○ 1167			● 2632	● 0747	● 1194											
	SNMG 120408 - UL	0.8	0.10~0.30	1.0~3.0		○ 0389			● 2634	● 0390	● 0391											
-UM  Medium Machining Unstable condition	SNMG 120408 - UM	0.8	0.15~0.30	1.0~3.0		○ 0983	○ 0739		● 2635	● 0784	● 0740											

Turning Inserts - Negative SNMG (90° Square)

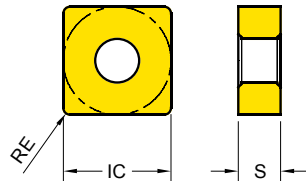

Series	IC	S
SN** 0903	9.525	3.18
SN** 1204	12.700	4.76
SN** 1506	15.875	6.35
SN** 1906	19.050	6.35

EDP 2200..

● : Stock item ○ : Order made item

SNMG	Designation	RE	Fn (mm/rev.)	Ap (mm)	K10	P05	P10	P15	P10	P20	P30	P20	M25	M15	M30	M40	S10	P15	M15	N20	N20		
					YG1010	YG1001	YG3010	YG3015	YG3115	YG3020	YG3030	YG801	YG2025	YG211	YG213	YG214	YG401	YT100	YG100	YG10			
-UG Medium Machining at stable condition	SNMG 120408 - UG	0.8	0.20~0.40	1.0~3.0	●	○	○			●	●	○											
	SNMG 120412 - UG	1.2	0.20~0.40	1.5~3.0	●	○	○			●	●	○											
	SNMG 120416 - UG	1.6	0.20~0.40	2.0~3.0	●	○	○			●	●	○											
-UC Cast iron and Medium roughing	SNMG 120408 - UC	0.8	0.20~0.40	1.0~4.0	●	○	○			●	●	●											
	SNMG 120412 - UC	1.2	0.20~0.40	1.5~4.0	●	○	○			●	●	○											
	SNMG 120416 - UC	1.6	0.20~0.40	2.0~5.0	●	○	○			●	●	○											
-UR Roughing	SNMG 120408 - UR	0.8	0.30~0.50	1.0~5.0	●	○	○			●	●	●											
	SNMG 120412 - UR	1.2	0.30~0.50	1.5~5.0	●	○	○			●	●	○											
	SNMG 120416 - UR	1.6	0.30~0.50	2.0~5.0	●	○	○	○		●	●	●											
	SNMG 190612 - UR	1.2	0.30~0.80	3.0~9.0						●	●	●											
	SNMG 190616 - UR	1.6	0.30~0.80	3.0~9.0	●					●	●	●											
-KR Cast Iron Heavy Roughing	SNMG 120412 - KR	1.2	0.30~0.60	1.5~5.0	●	○	○			●													
	SNMG 120416 - KR	1.6	0.30~0.60	2.0~5.0	●	○	○	○		●													

Turning Inserts - Negative SNMG (90° Square)

TURNING

PARTING & GROOVING

MILLING

DRILLING



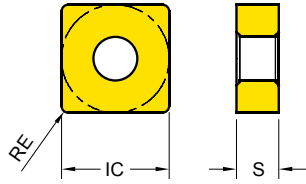

TECHNICAL INFORMATION



Series	IC	S
SN** 0903	9.525	3.18
SN** 1204	12.700	4.76
SN** 1506	15.875	6.35
SN** 1906	19.050	6.35

EDP 2200..

● : Stock item ○ : Order made item

SNMG	Designation	RE	Fn (mm/rev.)	Ap (mm)	K10	P05	P10	P15	P10	P20	P30	P20	M25	M15	M30	M40	S10	P15	M15	N20	N20	
					YG1010	K20	K30	YG3010	YG3015	YG3115	YG3020	YG3030	YG801	YG2025	YG211	YG213	YG214	YG401	YT100	YG100	YG10	
-MF  Stainless steel Finishing	SNMG 120404 - MF	0.4	0.07~0.30	0.2~1.5													●	●	●	○		
	SNMG 120408 - MF	0.8	0.07~0.30	0.2~1.5								○		●	●	●	●	○	○	○		
	SNMG 120412 - MF	1.2	0.07~0.30	0.2~1.5								○		●	●	●	●	○	○	○		
-MM  Stainless steel Medium	SNMG 120408 - MM	0.8	0.20~0.35	1.0~3.5												●	●	●	○			
	SNMG 120412 - MM	1.2	0.20~0.35	1.5~3.5												●	●	●	○			
-MG  Stainless steel General	SNMG 120404 - MG	0.4	0.20~0.40	0.5~4.0									●									
	SNMG 120408 - MG	0.8	0.20~0.40	1.0~4.0									●	●	●	●	●					
	SNMG 120412 - MG	1.2	0.20~0.40	1.5~4.0									●									
-MR  Stainless steel Roughing	SNMG 120408 - MR	0.8	0.30~0.55	2.0~5.5							○		●	●	●	●						
	SNMG 120412 - MR	1.2	0.30~0.55	2.0~5.5							○		●	●	●	●						
	SNMG 120416 - MR	1.6	0.30~0.55	2.0~5.5									●									

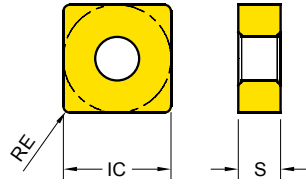

Turning Inserts - Negative SNMG (90° Square)



Series	IC	S
SN** 0903	9.525	3.18
SN** 1204	12.700	4.76
SN** 1506	15.875	6.35
SN** 1906	19.050	6.35

EDP 2200..

● : Stock item ○ : Order made item

SNMG	Designation	RE	Fn (mm/rev.)	Ap (mm)	K10	P05	P10	P15	P10	P20	P30	P20	M25	M15	M30	M40	S10	P15	M15	N20	N20	
					YG1010	YG1001	YG3010	YG3015	YG3115	YG3020	YG3030	YG801	YG2025	YG211	YG213	YG214	YG401	YT100	YG100	YG10		
-SM  HRSA Medium	SNMG 090304 - SM	0.4	0.08 ~ 0.20	0.5 ~ 3.0																		
	SNMG 120408 - SM	0.8	0.10 ~ 0.25	0.5 ~ 4.0																		
-SR  HRSA Roughing	SNMG 120408 - SR	0.8	0.10 ~ 0.40	0.5 ~ 4.0																		
	SNMG 120412 - SR	1.2	0.10 ~ 0.40	0.5 ~ 4.0																		

Turning Inserts - Negative

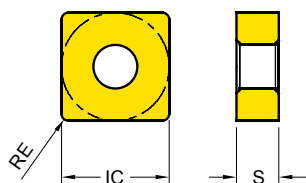

SNMG / SNMM - Heavy Turning (90° Square)



Series	IC	S
SN** 1506	15.875	6.35
SN** 1906	19.050	6.35
SN** 2507	25.400	7.94
SN** 2509	25.400	9.52

EDP 2200..

● : Stock item ○ : Order made item

SNMG SNMM	Designation	RE	Fn (mm/rev.)	Ap (mm)	K10	P05	P10	P15	P10	P20	P30	P20	M25	M15	M30	M40	S10	P15	M15	N20	N20	
					K20	K30	YG3010	YG3015	YG3115	YG3020	YG3030	YG801	YG2025	YG211	YG213	YG214	YG401	YT100	YG100	YG10		
NEW -UH  Low cutting force	SNMM 150612 - UH	1.2	0.35~0.60	2.0~5.5	○	○	○	○	○	○	○	○	○	○	○	○	○	○	○	○	○	○
	SNMM 190612 - UH	1.2	0.35~0.70	1.5~9.0	●	○	○	○	○	○	○	○	○	○	○	○	○	○	○	○	○	○
	SNMM 190616 - UH	1.6	0.35~0.70	2.0~9.0	●	○	○	○	○	○	○	○	○	○	○	○	○	○	○	○	○	○
	SNMM 190624 - UH	2.4	0.35~0.70	3.0~9.0	●	○	○	○	○	○	○	○	○	○	○	○	○	○	○	○	○	○
	SNMM 250924 - UH	2.4	0.40~0.80	3.0~10.0	●	○	○	○	○	○	○	○	○	○	○	○	○	○	○	○	○	○
-UR  Heavy General	SNMG 250924 - UR	2.4	0.40~1.00	5.0~12.0	○	○	○	○	○	○	○	○	○	○	○	○	○	○	○	○	○	
	SNMM 150612 - UT	1.2	0.45~0.70	2.0~6.0	○	○	○	○	○	○	○	○	○	○	○	○	○	○	○	○	○	○
NEW -UT  Heavy Roughing	SNMM 190612 - UT	1.2	0.50~1.00	3.0~12.0	●	○	○	○	○	○	○	○	○	○	○	○	○	○	○	○	○	
	SNMM 190616 - UT	1.6	0.50~1.00	4.0~12.0	●	○	○	○	○	○	○	○	○	○	○	○	○	○	○	○	○	○
	SNMM 190624 - UT	2.4	0.50~1.00	6.0~12.0	●	○	○	○	○	○	○	○	○	○	○	○	○	○	○	○	○	○
	SNMM 250724 - UT	2.4	0.55~1.20	6.0~13.0	○	○	○	○	○	○	○	○	○	○	○	○	○	○	○	○	○	○
	SNMM 250924 - UT	2.4	0.55~1.20	6.0~13.0	○	○	○	○	○	○	○	○	○	○	○	○	○	○	○	○	○	○

Turning Inserts - Negative



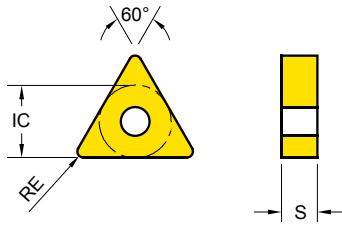



TNMA / TNMG (60° Triangle)



Series	IC	S
TN** 1604	9.525	4.76
TN** 2204	12.700	4.76

EDP 2200..

● : Stock item ○ : Order made item

TNMA TNMG	Designation	RE	Fn (mm/rev.)	Ap (mm)	K10	P05	P10	P15	P10	P20	P30	P20	M25	M15	M30	M40	S10	P15	M15	N20	N20		
					YG1010	YG1001	YG3010	YG3015	YG3115	YG3020	YG3030	YG801	YG2025	YG211	YG213	YG214	YG401	YT100	YG100	YG10			
..MA  Cast iron	TNMA 160404	0.4	0.15 ~ 0.50	0.5 ~ 5.0	●	○	○																
	TNMA 160408	0.8	0.15 ~ 0.50	1.0 ~ 5.0	●	○	○																
	TNMA 160412	1.2	0.15 ~ 0.50	1.5 ~ 5.0	●	○	○																
-UF  Finishing	TNMG 160404 - UF	0.4	0.05 ~ 0.25	0.5 ~ 2.5			○		●	●	●	○											
	TNMG 160408 - UF	0.8	0.05 ~ 0.25	1.0 ~ 2.5			○		●	●	●												
	TNMG 160412 - UF	1.2	0.05 ~ 0.25	1.5 ~ 2.5			○		●	●	●												
	TNMG 220404 - UF	0.4	0.10 ~ 0.35	0.5 ~ 4.0			○		●	●	●	○											
-UL  Light Machining and Sticky Material	TNMG 160404 - UL	0.4	0.10 ~ 0.30	0.5 ~ 3.0			○		●	●	●												
	TNMG 160408 - UL	0.8	0.10 ~ 0.30	1.0 ~ 3.0			○		●	●	●												
	TNMG 160412 - UL	1.2	0.10 ~ 0.30	1.5 ~ 3.0			○		●	●	●												
-UM  Medium Machining Unstable condition	TNMG 160404 - UM	0.4	0.15 ~ 0.30	0.5 ~ 3.0	○	○	○	○	●	●	●												
	TNMG 160408 - UM	0.8	0.15 ~ 0.30	1.0 ~ 3.0	○	○	○	○	●	●	●												
	TNMG 160412 - UM	1.2	0.15 ~ 0.30	1.5 ~ 3.0	○	○	○	○	●	●	●												
-UG  Medium Machining at stable condition	TNMG 160404 - UG	0.4	0.20 ~ 0.40	0.5 ~ 3.0	●	○	○		●	●	●												
	TNMG 160408 - UG	0.8	0.20 ~ 0.40	1.0 ~ 3.0	●	○	○		●	●	●												
	TNMG 160412 - UG	1.2	0.20 ~ 0.40	1.5 ~ 3.0	●	○	○		●	●	●												
	TNMG 220408 - UG	0.8	0.25 ~ 0.60	1.0 ~ 6.0	●	○	○		●	●	●												
	TNMG 220412 - UG	1.2	0.25 ~ 0.60	1.5 ~ 6.0	●	○	○		●	●	●												
	TNMG 220416 - UG	1.6	0.25 ~ 0.60	2.0 ~ 6.0	●	○	○		●	●	●												
-UC  Cast iron and Medium roughing	TNMG 160404 - UC	0.4	0.20 ~ 0.40	0.5 ~ 4.0	●	○	○		●	●	●												
	TNMG 160408 - UC	0.8	0.20 ~ 0.40	1.0 ~ 4.0	●	○	○		●	●	●												
	TNMG 160412 - UC	1.2	0.20 ~ 0.40	1.5 ~ 4.0	●	○	○		●	●	●												
	TNMG 220416 - UC	1.6	0.20 ~ 0.40	2.0 ~ 4.0																			
-UR  Roughing	TNMG 160408 - UR	0.8	0.30 ~ 0.50	1.0 ~ 5.0	●	○	○		●	●	●												
	TNMG 160412 - UR	1.2	0.30 ~ 0.50	1.5 ~ 5.0	●	○	○		●	●	●												
	TNMG 220412 - UR	1.2	0.30 ~ 0.65	1.5 ~ 7.0	●	○	○		●	●	●												
	TNMG 220416 - UR	1.6	0.30 ~ 0.65	2.0 ~ 7.0	●	○	○		●	●	●												

Turning Inserts - Negative TNMG (60° Triangle)

TURNING

PARTING & GROOVING

MILLING



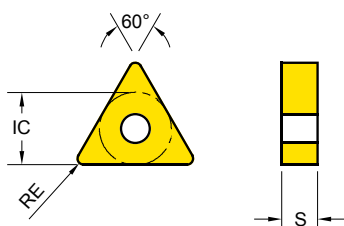

DRILLING

TECHNICAL INFORMATION

Series	IC	S
TN** 1604	9.525	4.76
TN** 2204	12.700	4.76



EDP 2200.. ● : Stock item ○ : Order made item

TNMG	Designation	RE	Fn (mm/rev.)	Ap (mm)	K10	P05	P10	P15	P10	P20	P30	P20	M25	M15	M30	M40	S10	P15	M15	N20	N20		
					YG1010	YG1001	YG3010	YG3015	YG3115	YG3020	YG3030	YG801	YG2025	YG211	YG213	YG214	YG401	YT100	YG100	YG10	K20	K30	K15
-MF  Stainless steel Finishing	TNMG 160404 - MF	0.4	0.07~0.3	0.2~1.5													●	●	●	○			
	TNMG 160408 - MF	0.8	0.07~0.3	0.2~1.5						○								●	●	●	○		
-MM  Stainless steel Medium	TNMG 160404 - MM	0.4	0.20~0.35	0.5~3.5													●	●	●	○			
	TNMG 160408 - MM	0.8	0.20~0.35	1.0~3.5														●	●	●	○		
	TNMG 160412 - MM	1.2	0.20~0.35	1.5~3.5														●	●	●	○		
-MG  Stainless steel General	TNMG 160404 - MG	0.4	0.20~0.40	0.5~4.0													●	●	●	●			
	TNMG 160408 - MG	0.8	0.20~0.40	1.0~4.0														●	●	●	●		
	TNMG 160412 - MG	1.2	0.20~0.50	2.0~4.0														●	●	●	●		
-MR  Stainless steel Roughing	TNMG 160408 - MR	0.8	0.30~0.55	2.0~5.5							○						●	●	●	●			
	TNMG 160412 - MR	1.2	0.30~0.55	2.0~5.5							○							●	●	●	●		

Turning Inserts - Negative



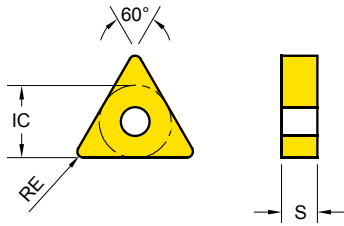



TNGG / TNMG (60° Triangle)



Series	IC	S
TN** 1604	9.525	4.76
TN** 2204	12.700	4.76

EDP 2200..

● : Stock item ○ : Order made item

TNGG TNMG	Designation	RE	Fn (mm/rev.)	Ap (mm)	K10	P05 K20	P10 K30	P15	P10	P20	P30	P20	M25	M15	M30	M40 S30	S10	P15 M15 K15	N20	N20				
					YG1010	YG1001	YG3010	YG3015	YG3115	YG3020	YG3030	YG801	YG2025	YG211	YG213	YG214	YG401	YT100	YG100	YG10				
-SF  Stainless steel Finishing	TNMG 160408 - SF	0.8	0.10 ~ 0.25	0.5 ~ 3.0																				
																	●	1427						
-SM  Stainless steel Medium	TNMG 160408 - SM	0.8	0.10 ~ 0.25	0.5 ~ 4.0										○	○	○	●							
	TNMG 160412 - SM	1.2	0.10 ~ 0.25	0.5 ~ 4.0										○	○	○	●							
														○	○	○	●							
														○	○	○	●							
-SR  HRSA Roughing	TNMG 160408 - SR	0.8	0.10 ~ 0.40	0.5 ~ 4.0																				
	TNMG 160412 - SR	1.2	0.10 ~ 0.40	0.5 ~ 4.0														●	1307					
																		●	1306					
NEW -PSF  Cermet Finishing	TNMG 160404 - PSF	0.4	0.07 ~ 0.30	0.4 ~ 2.5																	●	2535		
	TNMG 160408 - PSF	0.8	0.10 ~ 0.30	0.6 ~ 2.5																		●	2536	
NEW -C  Cermet Medium Left Hand Shown	TNGG 160402L - C	0.2	0.10 ~ 0.30	0.8 ~ 3.5																	○	2524		
	TNGG 160404L - C	0.4	0.12 ~ 0.30	1.0 ~ 3.5																		○	2526	
	TNGG 160408L - C	0.8	0.05 ~ 0.35	1.0 ~ 3.5																		○	2528	
NEW -C  Cermet Medium Right Hand Shown	TNGG 160402R - C	0.2	0.10 ~ 0.30	0.8 ~ 3.5																		○	2525	
	TNGG 160404R - C	0.4	0.12 ~ 0.30	1.0 ~ 3.5																			○	2527
	TNGG 160408R - C	0.8	0.05 ~ 0.35	1.0 ~ 3.5																			○	2529

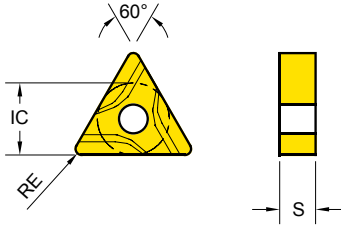

Turning Inserts - Negative TNUX (60° Triangle)

Series	IC	S
TN** 1604	9.525	4.76



EDP 2200..

● : Stock item ○ : Order made item

TNUX	Designation	RE	Fn (mm/rev.)	Ap (mm)	K10	P05	P10	P15	P10	P20	P30	P20	M25	M15	M30	M40	S10	P15	M15	N20	N20
					K20	K30	YG3010	YG3015	YG3115	YG3020	YG3030	YG801	YG2025	YG211	YG213	YG214	YG401	YT100	YG100	YG10	
..UX  Left Hand Shown	TNUX 160404 L	0.4	0.10~0.30	0.5~4.0	○	○	○	●	●	●	○										
	TNUX 160408 L	0.8	0.10~0.40	1.0~5.0	○	○	○	●	●	●	○										
..UX  Right Hand Shown	TNUX 160404 R	0.4	0.10~0.30	0.5~4.0	●	●	●	●	●	●	●										
	TNUX 160408 R	0.8	0.10~0.40	1.0~5.0	●	●	●	●	●	●	●										

TURNING

PARTING & GROOVING

MILLING

DRILLING

TECHNICAL INFORMATION

Turning Inserts - Negative

VNMA / VNMG (35° Rhombic)

Series	IC	S
VN** 1604	9.525	4.76

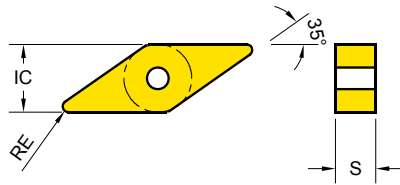

EDP 2200..

● : Stock item ○ : Order made item

VNMA VNMG	Designation	RE	Fn (mm/rev.)	Ap (mm)	K10	P05	P10	P15	P10	P20	P30	P20	M25	M15	M30	M40	S10	P15	M15	N20	N20	
					YG1010	YG1001	YG3010	YG3015	YG3115	YG3020	YG3030	YG801	YG2025	YG211	YG213	YG214	YG401	YT100	YG100	YG10		
	VNMA 160408	0.8	0.15~0.40	1.0~5.0	●	○	○															
..MA Cast iron					1573	0162	1275															
	VNMG 160404 - UF	0.4	0.05~0.25	0.5~2.5			○			●	●	●										
-UF Finishing	VNMG 160408 - UF	0.8	0.05~0.25	1.0~2.5			○			●	●	●										
	VNMG 160404 - UL	0.4	0.10~0.30	0.5~3.0			○			●	●	●										
-UL Light Machining and Sticky Material	VNMG 160408 - UL	0.8	0.10~0.30	1.0~3.0			○			●	●	●										
	VNMG160412 - UL	1.2	0.10~0.30	1.5~3.0						●												
	VNMG 160408 - UM	0.8	0.15~0.30	1.0~3.0		○	○			●	●	●										
-UM Medium Machining Unstable condition	VNMG 160412 - UM	1.2	0.15~0.30	1.5~3.0		○	○			●	●	●										
	VNMG 160404 - UG	0.4	0.20~0.40	0.5~3.0	●	○	○			●	●	●										
-UG Medium Machining at stable condition	VNMG 160408 - UG	0.8	0.20~0.40	1.0~3.0	●	○	○			●	●	●										○
	VNMG 160412 - UG	1.2	0.20~0.40	1.5~3.0	●	○	○			●	●	●										
	VNMG 160404 - UC	0.4	0.20~0.40	0.5~3.5	●	○	○			●	●	●										
-UC Cast iron and Medium roughing	VNMG 160408 - UC	0.8	0.20~0.40	1.0~3.5	●	○	○			●	●	●										
	VNMG 160412 - UC	1.2	0.20~0.40	1.5~3.5	●	○	○			●	●	●										
	VNMG 160412 - UR	1.2	0.30~0.50	1.5~5.0	●	○	○	○		●	●	●										○
-UR Roughing					1638	1231	0430	0871		2380	0431	0432	0051									





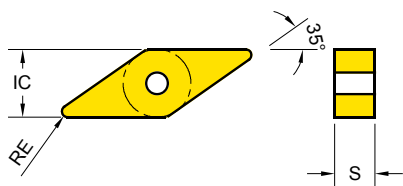

Turning Inserts - Negative VNMG (35° Rhombic)

Series	IC	S
VN** 1604	9.525	4.76



EDP 2200..

● : Stock item ○ : Order made item

VNMG	Designation	RE	Fn (mm/rev.)	Ap (mm)	K10	P05	P10	P15	P10	P20	P30	P20	M25	M15	M30	M40	S10	P15	M15	N20	N20
					YG1010	K20	K30	YG1001	YG3010	YG3015	YG3115	YG3020	YG3030	YG801	YG2025	YG211	YG213	YG214	YG401	YT100	YG100
-MF  Stainless steel Finishing	VNMG 160404 - MF	0.4	0.07~0.30	0.2~1.5												●	●	●	○		
	VNMG 160408 - MF	0.8	0.07~0.30	0.2~1.5								○		●	●	●	●	○	○		
-MM  Stainless steel Medium	VNMG 160404 - MM	0.4	0.20~0.35	0.5~3.5												●	●	●	○		
	VNMG 160408 - MM	0.8	0.20~0.35	1.0~3.5												●	●	●	○		
-MG  Stainless steel Genera	VNMG 160404 - MG	0.4	0.20~0.40	0.5~4.0											●						
	VNMG 160408 - MG	0.8	0.20~0.40	1.0~4.0											●						
	VNMG 160412 - MG	1.2	0.20~0.40	1.5~4.0											●						
-MR  Stainless steel Roughing	VNMG 160408 - MR	0.8	0.30~0.55	2.0~5.5							○				●	●	●	●			
-SR  HRSA Medium	VNMG 160408 - SR	0.8	0.10~0.40	0.5~4.0														●			
NEW -PSF  Cermet Finishing	VNMG 160404 - PSF	0.4	0.07~0.30	0.3~2.0																●	
	VNMG 160408 - PSF	0.8	0.10~0.30	0.5~2.0																	●

Turning Inserts - Negative



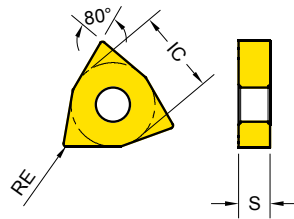

WNMA / WNMG (80° Trigon)

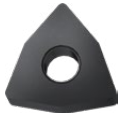

Series	IC	S
WN** 0604	9.525	4.76
WN** 0804	12.700	4.76

EDP 2200..

● : Stock item ○ : Order made item

WNMA WNMG	Designation	RE	Fn (mm/rev.)	Ap (mm)	K10	P05	P10	P15	P10	P20	P30	P20	M25	M15	M30	M40	S10	P15	M15	N20	N20		
					YG1010	YG1001	YG3010	YG3015	YG3115	YG3020	YG3030	YG801	YG2025	YG211	YG213	YG214	YG401	YT100	YG100	YG10			
..MA  Cast iron	WNMA 080404	0.4	0.15 ~ 0.50	0.5 ~ 5.0	●	○	○																
	WNMA 080408	0.8	0.15 ~ 0.50	1.0 ~ 5.0	●	○	○																
	WNMA 080412	1.2	0.15 ~ 0.50	1.5 ~ 5.0	●	○	○																
-UF  Finishing	WNMG 060404 - UF	0.4	0.05 ~ 0.20	0.5 ~ 2.0			○		●	●	●	○											
	WNMG 080404 - UF	0.4	0.05 ~ 0.25	0.5 ~ 2.5			○		●	●	●	○											
	WNMG 080408 - UF	0.8	0.05 ~ 0.25	1.0 ~ 2.5			○		●	●	●												
	WNMG 080412 - UF	1.2	0.05 ~ 0.25	1.5 ~ 2.5			○		●	●	●												
-UL  Light Machining and Sticky Material	WNMG 060408 - UL	0.8	0.10 ~ 0.30	1.0 ~ 2.5			○		●	●	●												
	WNMG 080404 - UL	0.4	0.10 ~ 0.30	0.5 ~ 3.0			○		●	●	●												
	WNMG 080408 - UL	0.8	0.10 ~ 0.30	1.0 ~ 3.0			○		●	●	●												
	WNMG 080412 - UL	1.2	0.10 ~ 0.30	1.5 ~ 3.0			○		●	●	●												
-UM  Medium Machining Unstable condition	WNMG 060404 - UM	0.4	0.15 ~ 0.30	0.5 ~ 2.5	○	○	○		●	●	●												
	WNMG 060408 - UM	0.8	0.15 ~ 0.30	1.0 ~ 2.5	○	○	○		●	●	●												
	WNMG 080404 - UM	0.4	0.15 ~ 0.30	0.5 ~ 3.0		○	○		●	●	●												
	WNMG 080408 - UM	0.8	0.15 ~ 0.30	1.0 ~ 3.0		○	○		●	●	●												
	WNMG 080412 - UM	1.2	0.15 ~ 0.30	1.5 ~ 3.0		○	○		●	●	●												
	WNMG 080416 - UM	1.6	0.15 ~ 0.30	2.0 ~ 3.0		○	○		●	●	●												

Turning Inserts - Negative WNMG (80° Trigon)

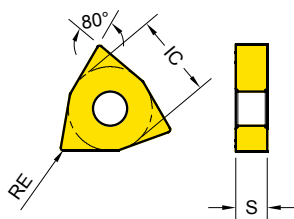

Series	IC	S
WN** 0604	9.525	4.76
WN** 0804	12.700	4.76

TURNING

PARTING & GROOVING





MILLING

DRILLING

TECHNICAL INFORMATION

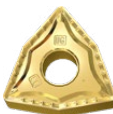
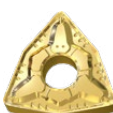
EDP 2200..

● : Stock item ○ : Order made item

WNMG	Designation	RE	Fn (mm/rev.)	Ap (mm)	K10	P05	P10	P15	P10	P20	P30	P20	M25	M15	M30	M40	S10	P15	M15	N20	N20	
					YG1010	YG1001	YG3010	YG3015	YG3115	YG3020	YG3030	YG801	YG2025	YG211	YG213	YG214	YG401	YT100	YG100	YG10	K20	K30
-UG 	WNMG 060408 - UG	0.8	0.20~0.40	1.0~3.0	●	○	○			●	●	○										
	WNMG 080404 - UG	0.4	0.20~0.40	0.5~3.0	●	○	○			●	●	○										
	WNMG 080408 - UG	0.8	0.20~0.40	1.0~3.0	●	○	○	○		●	●	○										
	WNMG 080412 - UG	1.2	0.20~0.40	1.5~3.0	●	○	○	○		●	●	○										
	WNMG 080416 - UG	1.6	0.20~0.40	2.0~4.0	●	○	○	○		●	●	○										
-PWM 	WNMG 080408 - PWM	0.8	0.10~0.50	0.8~3.5						●												
-UC 	WNMG 060408 - UC	0.8	0.20~0.40	1.0~3.0	●	○	○			●	●	○										
	WNMG 080404 - UC	0.4	0.20~0.40	0.5~4.0	●	○	○			●	●	○										
	WNMG 080408 - UC	0.8	0.20~0.40	1.0~4.0	●	○	○	○		●	●	○										
	WNMG 080412 - UC	1.2	0.20~0.40	1.5~4.0	●	○	○	○		●	●	○										
	WNMG 080416 - UC	1.6	0.20~0.40	2.0~4.0	●	○	○	○		●	●	○										
-UR 	WNMG 060412 - UR	1.2	0.30~0.50	1.5~4.0	●	○	○			●	●	○										
	WNMG 080408 - UR	0.8	0.30~0.50	1.0~5.0	●	○	○			●	●	○										
	WNMG 080412 - UR	1.2	0.30~0.50	1.5~5.0	●	○	○	○		●	●	○									○	
	WNMG 080416 - UR	1.6	0.30~0.50	2.0~5.0	●	○	○	○		●	●	○										
-KR 	WNMG 080408 - KR	0.8	0.30~0.60	1.0~5.0	●	○	○			●												
	WNMG 080412 - KR	1.2	0.30~0.60	1.5~5.0	●	○	○			●												

Turning Inserts - Negative



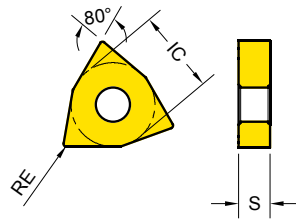

WNMG (80° Trigon)



Series	IC	S
WN** 0604	9.525	4.76
WN** 0804	12.700	4.76

EDP 2200..

● : Stock item ○ : Order made item

WNGM	Designation	RE	Fn (mm/rev.)	Ap (mm)	K10	P05	P10	P15	P10	P20	P30	P20	M25	M15	M30	M40	S10	P15	M15	N20	N20			
					YG1010	K20	K30	YG3010	YG3015	YG3115	YG3020	YG3030	YG801	YG2025	YG211	YG213	YG214	YG401	YT100	YG100	YG10			
-MF  Stainless steel Finishing	WNMG 060404 - MF	0.4	0.07 ~ 0.30	0.2 ~ 1.5																				
	WNMG 060408 - MF	0.8	0.07 ~ 0.30	0.2 ~ 1.5			○ 0833																	
	WNMG 080404 - MF	0.4	0.07 ~ 0.30	0.2 ~ 1.5																				
	WNMG 080408 - MF	0.8	0.07 ~ 0.30	0.2 ~ 1.5																				
-MM  Stainless steel Medium	WNMG 080404 - MM	0.4	0.20 ~ 0.35	0.5 ~ 3.5																				
	WNMG 080408 - MM	0.8	0.20 ~ 0.35	1.0 ~ 3.5																				
	WNMG 080412 - MM	1.2	0.20 ~ 0.35	1.5 ~ 3.5																				
-MG  Stainless steel General	WNMG 060404 - MG	0.4	0.20 ~ 0.40	0.5 ~ 3.0																				
	WNMG 060408 - MG	0.8	0.20 ~ 0.40	1.0 ~ 3.0																				
	WNMG 060412 - MG	1.2	0.20 ~ 0.40	1.5 ~ 3.0																				
	WNMG 080404 - MG	0.4	0.20 ~ 0.40	0.5 ~ 4.0																				
	WNMG 080408 - MG	0.8	0.20 ~ 0.40	1.0 ~ 4.0																				
	WNMG 080412 - MG	1.2	0.20 ~ 0.40	1.5 ~ 4.0																				
-MR  Stainless steel Roughing	WNMG 060412 - MR	1.2	0.30 ~ 0.55	1.2 ~ 4.0																				
	WNMG 080408 - MR	0.8	0.30 ~ 0.55	2.0 ~ 5.5																				
	WNMG 080412 - MR	1.2	0.30 ~ 0.55	2.0 ~ 5.5																				

Turning Inserts - Negative WNGG / WNMG (80° Trigon)

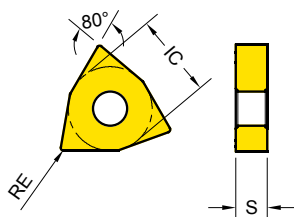

Series	IC	S
WN** 0604	9.525	4.76
WN** 0804	12.700	4.76

TURNING

PARTING & GROOVING





MILLING

DRILLING

TECHNICAL INFORMATION

EDP 2200..

● : Stock item ○ : Order made item

WNGG WNMG	Designation	RE	Fn (mm/rev.)	Ap (mm)	K10	P05	P10	P15	P10	P20	P30	P20	M25	M15	M30	M40	S10	P15	M15	N20	N20	
					YG1010	YG1001	YG3010	YG3015	YG3115	YG3020	YG3030	YG801	YG2025	YG211	YG213	YG214	YG401	YT100	YG100	YG10		
-SF  HRSA Finishing	WNGG 080408 - SF	0.8	0.10~0.25	0.50~3.00																		
																		●				
-SM  HRSA Medium	WNMG 080408 - SM	0.8	0.10~0.25	0.5~4.0												○	○	○	●			
	WNMG 080412 - SM	1.2	0.10~0.25	0.5~4.0												○	○	○	●			
-SR  HRSA Roughing	WNMG 060412 - SR	1.2	0.10~0.40	0.5~3.0														●				
	WNMG 080408 - SR	0.8	0.10~0.40	0.5~4.0														●				
	WNMG 080412 - SR	1.2	0.10~0.40	0.5~4.0														●				
-PSF  Cermet Finishing	WNMG 080404 - PSF	0.4	0.07~0.30	0.4~2.5															●			
	WNMG 080408 - PSF	0.8	0.10~0.30	0.6~2.5															●			

Turning Inserts - Positive

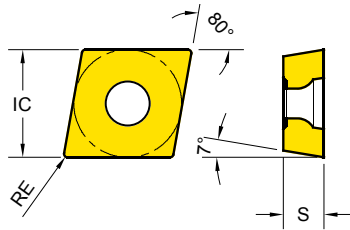

CCGT / CCMT (80° Rhombic)



Series	IC	S
CC** 0602	6.350	2.38
CC** 09T3	9.525	3.97
CC** 1204	12.700	4.76

EDP 2200..

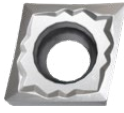
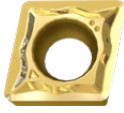
● : Stock item ○ : Order made item

CCGT CCMT	Designation	RE	Fn (mm/rev.)	Ap (mm)	K10	P05	P10	P15	P10	P20	P30	P20	M25	M15	M30	M40	S10	P15	M15	N20	N20		
					YG1010	YG1001	YG3010	YG3015	YG3115	YG3020	YG3030	YG801	YG2025	YG211	YG213	YG214	YG401	YT100	YG100	YG10			
-AL  Aluminum	CCGT 060202 - AL	0.2	0.02 ~ 0.15	0.1 ~ 2.0																		●	
	CCGT 060204 - AL	0.4	0.02 ~ 0.15	0.5 ~ 2.0																			●
	CCGT 09T302 - AL	0.2	0.02 ~ 0.08	0.5 ~ 1.0																			●
	CCGT 09T304 - AL	0.4	0.05 ~ 0.25	0.5 ~ 2.0																			●
	CCGT 09T308 - AL	0.8	0.10 ~ 0.35	1.0 ~ 3.0																			●
	CCGT 120402 - AL	0.2	0.04 ~ 0.15	0.1 ~ 1.0																			●
	CCGT 120404 - AL	0.4	0.04 ~ 0.20	0.3 ~ 1.5																			●
	CCGT 120408 - AL	0.8	0.04 ~ 0.30	0.6 ~ 2.5																			●
-UF  Finishing	CCMT 060204 - UF	0.4	0.05 ~ 0.20	0.5 ~ 2.0			○	○	●	●	●												
	CCMT 09T304 - UF	0.4	0.05 ~ 0.25	0.5 ~ 2.0			○		●	●	●												
	CCMT 09T308 - UF	0.8	0.05 ~ 0.25	1.0 ~ 2.0			○		●	●	●												
	CCMT 120404 - UF	0.4	0.10 ~ 0.25	1.0 ~ 5.0					●	●	●												
-UG  General	CCMT 060204 - UG	0.4	0.10 ~ 0.25	0.5 ~ 2.0	●		○		●	●	●	○					○						
	CCMT 060208 - UG	0.8	0.10 ~ 0.25	0.8 ~ 2.0	●		○		●	●	●	○					○						
	CCMT 09T304 - UG	0.4	0.15 ~ 0.30	0.5 ~ 2.5	●		○		●	●	●	○					○						
	CCMT 09T308 - UG	0.8	0.15 ~ 0.30	0.8 ~ 2.5	●	○			●	●	●	○				○		○					
	CCMT 120404 - UG	0.4	0.15 ~ 0.35	0.5 ~ 3.0	●		○		●	●	●	○											
	CCMT 120408 - UG	0.8	0.15 ~ 0.35	0.8 ~ 3.0	●		○		●	●	●	○						○					
	CCMT 120412 - UG	1.2	0.15 ~ 0.35	1.2 ~ 3.0	●		○		●	●	●	○						○					

Turning Inserts - Positive CCGT / CCMT (80° Rhombic)

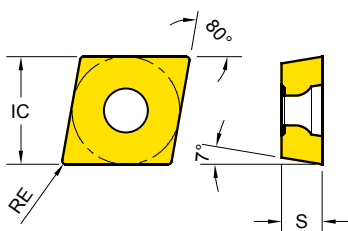

Series	IC	S
CC** 0602	6.350	2.38
CC** 09T3	9.525	3.97
CC** 1204	12.700	4.76

TURNING

PARTING & GROOVING





MILLING

DRILLING

TECHNICAL INFORMATION

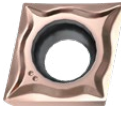
EDP 2200..

● : Stock item ○ : Order made item

CCGT CCMT	Designation	RE	Fn (mm/rev.)	Ap (mm)	K10	P05	P10	P15	P10	P20	P30	P20	M25	M15	M30	M40	S10	P15	M15	N20	N20	
					YG1010	K20	K30	YG3010	YG3015	YG3115	YG3020	YG3030	YG801	YG2025	YG211	YG213	YG214	YG401	YT100	YG100	YG10	
-SF  HRSA Finishing	CCGT 060201 - SF	0.1	0.02~0.15	0.10~1.5														●	●			
	CCGT 060202 - SF	0.2	0.02~0.15	0.10~1.5														●	●			
	CCGT 060204 - SF	0.4	0.03~0.20	0.10~2.4														●	●			
	CCGT 09T301 - SF	0.1	0.02~0.15	0.10~2.5														●	●			
	CCGT 09T302 - SF	0.2	0.02~0.15	0.10~2.5														●	●			
	CCGT 09T304 - SF	0.4	0.03~0.20	0.10~2.5														●	●			
	CCGT 09T308 - SF	0.8	0.03~0.25	0.10~2.5														●	●			
																		●	●			
-MF  Stainless steel Finishing	CCMT 060208 - MF	0.8	0.05~0.20	1.00~2.0												●	●	●	●			
	CCMT 09T302 - MF	0.2	0.04~0.15	0.08~2.0												●	●	●	●			
	CCMT 09T304 - MF	0.4	0.06~0.25	0.10~2.0												●	●	●	●			
	CCMT 09T308 - MF	0.8	0.08~0.30	0.15~2.0												●	●	●	●			
-MM  Stainless steel Medium	CCMT 09T304 - MM	0.4	0.08~0.25	0.25~3.0												●	●	●	●			
	CCMT 09T308 - MM	0.8	0.10~0.30	0.50~3.0												●	●	●	●			
-PF  Cermet Finishing	CCMT 09T302 - PF	0.2	0.04~0.15	0.08~2.0																●		
	CCMT 09T304 - PF	0.4	0.06~0.25	0.10~2.0																	●	
	CCMT 09T308 - PF	0.8	0.08~0.30	0.15~2.0																	●	
-PM  Cermet Medium	CCMT 09T304 - PM	0.4	0.08~0.25	0.25~3.0																	●	
	CCMT 09T308 - PM	0.8	0.10~0.30	0.50~3.0																		●

Turning Inserts - Positive

DCGT / DCMT (55° Rhombic)

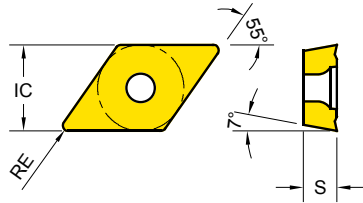

Series	IC	S
DC** 0702	6.350	2.38
DC** 11T3	9.525	3.97

EDP 2200..

● : Stock item ○ : Order made item

DCGT DCMT	Designation	RE	Fn (mm/rev.)	Ap (mm)	K10	P05 K20	P10 K30	P15	P10	P20	P30	P20	M25	M15	M30	M40 S30	S10	P15 M15 K15	N20	N20		
					YG1010	YG1001	YG3010	YG3015	YG3115	YG3020	YG3030	YG801	YG2025	YG211	YG213	YG214	YG401	YT100	YG100	YG10		
-AL Aluminum	DCGT 070202 - AL	0.2	0.01 ~ 0.08	0.05 ~ 1.0																	● 1399	
	DCGT 070204 - AL	0.4	0.02 ~ 0.15	0.10 ~ 2.0																		● 1400
	DCGT 11T301 - AL	0.1	0.01 ~ 0.08	0.50 ~ 1.0																		● 2101
	DCGT 11T302 - AL	0.2	0.02 ~ 0.08	0.50 ~ 1.0																		● 0342
	DCGT 11T304 - AL	0.4	0.05 ~ 0.25	0.50 ~ 2.0																		● 0332
	DCGT 11T308 - AL	0.8	0.10 ~ 0.30	1.00 ~ 2.5																		● 0083
-UF Finishing	DCMT 070204 - UF	0.4	0.05 ~ 0.20	0.50 ~ 2.0			○ 0207		● 2397	● 0208	● 0209					○ 1909	○ 1903					
	DCMT 11T304 - UF	0.4	0.05 ~ 0.25	0.50 ~ 2.0			○ 0213		● 2208	● 0214	● 0215					○ 1044	○ 1043	○ 1910				
	DCMT 11T308 - UF	0.8	0.05 ~ 0.25	1.00 ~ 2.0	● 2053		○ 0219		● 1897	● 0220	● 0221											
-UG General	DCMT 070204 - UG	0.4	0.10 ~ 0.25	0.50 ~ 2.0	● 1849		○ 0210		● 2391	● 0211	● 0212	○ 0013										
	DCMT 070208 - UG	0.8	0.10 ~ 0.25	0.80 ~ 2.0	● 1850		○ 0484		● 2386	● 0717	● 1136											
	DCMT 11T304 - UG	0.4	0.15 ~ 0.30	0.50 ~ 2.5	● 1831	○ 0677	○ 0216		● 2209	● 0217	● 0218	○ 0014				○ 1520	○ 1522	○ 1521				
	DCMT 11T308 - UG	0.8	0.15 ~ 0.30	0.80 ~ 2.5	● 1832	○ 0678	○ 0222		● 2215	● 0223	● 0224	○ 0015										
	DCMT 11T312 - UG	1.2	0.15 ~ 0.35	1.50 ~ 3.0					● 2605	● 2056												

Turning Inserts - Positive DCGT / DCMT (55° Rhombic)

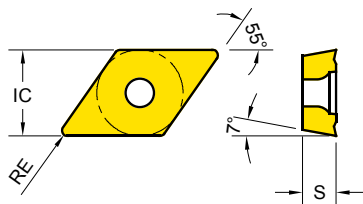

Series	IC	S
DC** 0702	6.350	2.38
DC** 11T3	9.525	3.97

TURNING

PARTING & GROOVING





MILLING

DRILLING

TECHNICAL INFORMATION

EDP 2200..

● : Stock item ○ : Order made item

DCGT DCMT	Designation	RE	Fn (mm/rev.)	Ap (mm)	K10	P05	P10	P15	P10	P20	P30	P20	M25	M15	M30	M40	S10	P15	M15	N20	N20	
					YG1010	K20	K30	YG3010	YG3015	YG3115	YG3020	YG3030	YG801	YG2025	YG211	YG213	YG214	YG401	YT100	YG100	YG10	
	DCGT 070201 - SF	0.1	0.02~0.15	0.10~1.5														●	●			
	DCGT 070202 - SF	0.2	0.02~0.15	0.10~1.5														●	●			
NEW	 HRSA Finishing	DCGT 070204 - SF	0.4	0.03~0.20	0.10~1.5												○	●	●			
-SF		DCGT 11T301 - SF	0.1	0.01~0.05	0.10~2.5													●	●			
	DCGT 11T302 - SF	0.2	0.02~0.15	0.10~2.5													○	●	●			
	DCGT 11T304 - SF	0.4	0.03~0.20	0.10~2.5													○	●	●			
	DCGT 11T308 - SF	0.8	0.03~0.20	0.10~2.5													○	●	●			
																		○	○	●	●	
																		○	○	●	●	
																		○	○	●	●	
																		○	○	●	●	
																		○	○	●	●	
NEW	 Stainless steel Finishing	DCMT 070204 - MF	0.4	0.05~0.17	0.08~1.5												●	●	●	●	●	
-MF		DCMT 11T302 - MF	0.2	0.04~0.15	0.08~2.0													●	●	●	●	●
	DCMT 11T304 - MF	0.4	0.06~0.25	0.10~2.0													●	●	●	●	●	
	DCMT 11T308 - MF	0.8	0.07~0.20	0.15~2.0													●	●	●	●	●	
																		●	●	●	●	
																		●	●	●	●	
NEW	 Stainless steel Medium	DCMT 070204 - MM	0.4	0.08~0.30	0.20~2.3												●	●	●	●	●	
-MM		DCMT 070208 - MM	0.8	0.08~0.25	0.50~1.5								○					●	●	●	●	●
	DCMT 11T304 - MM	0.4	0.06~0.17	0.25~3.0													●	●	●	●	●	
	DCMT 11T308 - MM	0.8	0.08~0.25	0.50~3.0													●	●	●	●	●	
																		●	●	●	●	
																		●	●	●	●	
																		●	●	●	●	
NEW	 Cermet Finishing	DCMT 070204 - PF	0.4	0.05~0.17	0.08~1.5																●	
-PF		DCMT 11T302 - PF	0.2	0.04~0.15	0.08~2.0																	●
	DCMT 11T304 - PF	0.4	0.06~0.25	0.10~2.0																		●
	DCMT 11T308 - PF	0.8	0.07~0.20	0.15~2.0																		●
																						●
																						●
NEW	 Cermet Medium	DCMT 070204 - PM	0.4	0.08~0.30	0.20~2.3																	●
-PM		DCMT 11T304 - PM	0.4	0.06~0.17	0.25~3.0																	
	DCMT 11T308 - PM	0.8	0.08~0.25	0.50~3.0																		●

Turning Inserts - Positive

RCMT (Round)

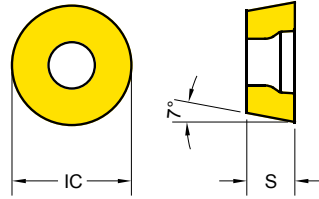

Series	IC	S
RC** 0602	6	2.38
RC** 0803	8	3.18
RC** 10T3	10	3.97
RC** 1204	12	4.76

EDP 2200..

● : Stock item ○ : Order made item

RCMT	Designation	RE	Fn (mm/rev.)	Ap (mm)	K10	P05	P10	P15	P10	P20	P30	P20	M25	M15	M30	M40	S10	P15	M15	N20	N20	
					YG1010	YG1001	YG3010	YG3015	YG3115	YG3020	YG3030	YG801	YG2025	YG211	YG213	YG214	YG401	YT100	YG100	YG10		
	RCMT 0602M0	3.0	0.05 ~ 0.25	0.2 ~ 1.2	●	○	○			●	●	●	○									
	RCMT 0803M0	4.0	0.05 ~ 0.30	0.5 ~ 1.5	●	○	○			●	●	●	○									
	RCMT 10T3M0	5.0	0.10 ~ 0.35	0.5 ~ 2.5	●	○	○			●	●	●	○									
	RCMT 1204M0	6.0	0.15 ~ 0.45	0.5 ~ 3.0	●	○	○			●	●	●	○									



General

Turning Inserts - Positive

RCMX - Heavy Turning (Round)

TURNING

PARTING & GROOVING

MILLING

DRILLING

TECHNICAL INFORMATION

Series	IC	S
RC** 1606	16	6.35
RC** 2006	20	6.35

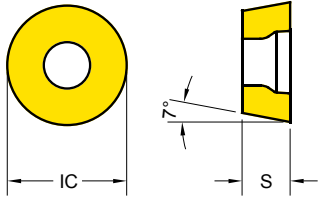

EDP 2200..

● : Stock item ○ : Order made item

RCMX	Designation	RE	Fn (mm/rev.)	Ap (mm)	K10	P05	P10	P15	P10	P20	P30	P20	M25	M15	M30	M40	S10	P15	M15	N20	N20	
					K20	K30	YG3010	YG3015	YG3115	YG3020	YG3030	YG801	YG2025	YG211	YG213	YG214	YG401	YT100	YG100	YG10		
	RCMX 1606M0 - UT	8.0	0.30~0.80	1.0~7.0	● 2441																	
	RCMX 2006M0 - UT	10.0	0.05~0.25	0.2~1.2																		

NEW
-UT



Heavy Roughing

Turning Inserts - Positive

SCGT / SCMT (Square)

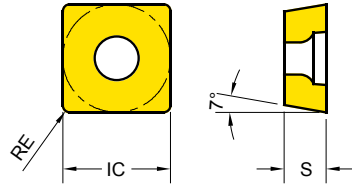

Series	IC	S
SC** 09T3	9.525	3.97
SC** 1204	12.700	4.76

EDP 2200..

● : Stock item ○ : Order made item

SCGT SCMT	Designation	RE	Fn (mm/rev.)	Ap (mm)	K10	P05	P10	P15	P10	P20	P30	P20	M25	M15	M30	M40	S10	P15	M15	N20	N20					
					YG1010	YG1001	YG3010	YG3015	YG3115	YG3020	YG3030	YG801	YG2025	YG211	YG213	YG214	YG401	YT100	YG100	YG10						
-AL Aluminium	SCGT 09T304 - AL	0.4	0.05 ~ 0.25	0.5 ~ 2.0																		● 1516				
	SCGT 09T308 - AL	0.8	0.10 ~ 0.35	1.0 ~ 3.0																			● 1517			
-UF Finishing	SCMT 09T304 - UF	0.4	0.05 ~ 0.25	0.5 ~ 2.0			○ 0386		● 2628	● 0387	● 0783															
	SCMT 09T308 - UF	0.8	0.05 ~ 0.25	1.0 ~ 2.0	● 2083		○ 1021		● 2629	● 1022	● 0997															
-UG General	SCMT 09T304 - UG	0.4	0.15 ~ 0.30	0.5 ~ 2.5	● 1834	○ 0455	○ 0482		● 2414	● 0916	● 1171	○ 0025														
	SCMT 09T308 - UG	0.8	0.15 ~ 0.30	0.8 ~ 2.5	● 1835	○ 0456	○ 0159		● 2383	● 0160	● 0161	○ 0026									○ 1904					
	SCMT 120408 - UG	0.8	0.15 ~ 0.35	0.8 ~ 3.0	● 1836	○ 0674	○ 0255		● 2393	● 0256	● 0257										○ 1911					
	SCMT 120412 - UG	1.2	0.15 ~ 0.35	1.5 ~ 3.0	● 2098																					
NEW -MF Stainless steel Finishing	SCMT 09T308 - MF	0.8	0.09 ~ 0.35	0.3 ~ 2.0																		● 2564				
NEW -MM Stainless steel Medium	SCMT 120408 - MM	0.8	0.10 ~ 0.30	0.6 ~ 4.0																		● 2519	● 1973	● 1974	● 1975	● 1976
NEW -PM Cermet Medium	SCMT 120408 - PM	0.8	0.10 ~ 0.30	0.6 ~ 4.0																					● 2530	

Turning Inserts - Positive TCGT / TCMT (Triangle)

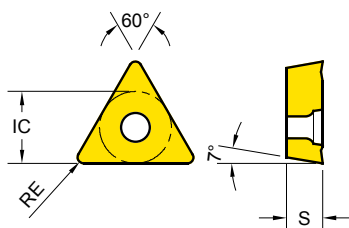

Series	IC	S
TC** 1102	6.350	2.38
TC** 16T3	9.525	3.97

TURNING

PARTING & GROOVING



MILLING

DRILLING

TECHNICAL INFORMATION

EDP 2200..

● : Stock item ○ : Order made item

TCGT TCMT	Designation	RE	Fn (mm/rev.)	Ap (mm)	K10	P05	P10	P15	P10	P20	P30	P20	M25	M15	M30	M40	S10	P15	M15	N20	N20		
					YG1010	YG1001	YG3010	YG3015	YG3115	YG3020	YG3030	YG801	YG2025	YG211	YG213	YG214	YG401	YT100	YG100	YG10	K20	K30	S30
-AL  Aluminum	TCGT 110204 - AL	0.4	0.03~0.30	0.5~2.0																		●	
	TCGT 16T302 - AL	0.2	0.02~0.05	0.5~1.0																			●
	TCGT 16T304 - AL	0.4	0.05~0.25	0.5~2.0																			●
	TCGT 16T308 - AL	0.8	0.10~0.35	1.0~3.0																			●
-UF  Finishing	TCMT 110204 - UF	0.4	0.05~0.20	0.5~2.0					○		●	●				○	○	○					
	TCMT 16T304 - UF	0.4	0.05~0.25	0.5~2.0					○		●	●				○	○						
	TCMT 16T308 - UF	0.8	0.05~0.25	0.8~2.0					○		●	●											
-UG  General	TCMT 110204 - UG	0.4	0.10~0.25	0.5~2.0	●	○	○			●	●	●	○										
	TCMT 110208 - UG	0.8	0.10~0.25	0.8~2.0	●					●	●	●											
	TCMT 16T304 - UG	0.4	0.15~0.30	0.5~2.5	●	○	○			●	●	●											
	TCMT 16T308 - UG	0.8	0.15~0.30	0.8~2.5	●	○	○			●	●	●	○					○					



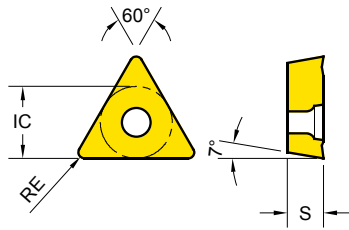

Turning Inserts - Positive TCMT (Triangle)



Series	IC	S
TC** 1102	6.350	2.38
TC** 16T3	9.525	3.97

EDP 2200..

● : Stock item ○ : Order made item

TCMT	Designation	RE	Fn (mm/rev.)	Ap (mm)	K10	P05 K20	P10 K30	P15	P10	P20	P30	P20	M25	M15	M30	M40 S30	S10	P15 M15 K15	N20	N20
					YG1010	YG1001	YG3010	YG3015	YG3115	YG3020	YG3030	YG801	YG2025	YG211	YG213	YG214	YG401	YT100	YG100	YG10
NEW -MF  Stainless steel Finishing	TCMT 110204 - MF	0.4	0.07 ~ 0.20	0.20 ~ 2.0														●		
	TCMT 110208 - MF	0.8	0.07 ~ 0.20	0.30 ~ 2.0														●		
	TCMT 16T304 - MF	0.4	0.06 ~ 0.25	0.10 ~ 2.0									●	●	●	●	●	●		
	TCMT 16T308 - MF	0.8	0.08 ~ 0.30	0.15 ~ 2.0									●	●	●	●	●	●		
NEW -MM  Stainless steel Medium	TCMT 16T304 - MM	0.4	0.08 ~ 0.25	0.25 ~ 3.0									●	●	●	●	●	●		
	TCMT 16T308 - MM	0.8	0.10 ~ 0.30	0.50 ~ 3.0									●	●	●	●	●	●		
													●	●	●	●	●	●		
													●	●	●	●	●	●		
NEW -PF  Cermet Medium	TCMT 16T304 - PF	0.4	0.06 ~ 0.25	0.10 ~ 2.0														●		
	TCMT 16T308 - PF	0.8	0.08 ~ 0.30	0.15 ~ 2.0														●		
NEW -PM  Cermet Medium	TCMT 16T304 - PM	0.4	0.08 ~ 0.25	0.25 ~ 3.0														●		
	TCMT 16T308 - PM	0.8	0.10 ~ 0.30	0.50 ~ 3.0														●		

Turning Inserts - Positive

VBGT / VBMT (35° Rhombic)

Series	IC	S
VB** 1103	6.350	3.18
VB** 1604	9.525	4.76

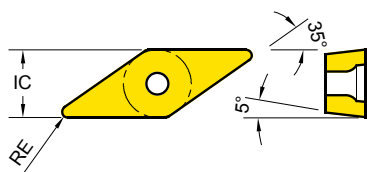

EDP 2200..

● : Stock item ○ : Order made item

VBGT VBMT	Designation	RE	Fn (mm/rev.)	Ap (mm)	YG1010	K10	P05	P10	P15	P10	P20	P30	P20	M25	M15	M30	M40	S10	P15	M15	N20	N20			
						K20	K30	YG3010	YG3015	YG3115	YG3020	YG3030	YG801	YG2025	YG211	YG213	YG214	YG401	YT100	YG100	YG10				
NEW -SF HRSA Finishing	VBGT 110301 - SF	0.1	0.01 ~ 0.20	0.10 ~ 1.5																					
	VBGT 110302 - SF	0.2	0.02 ~ 0.20	0.10 ~ 1.5																				● 2432	
	VBGT 110304 - SF	0.4	0.05 ~ 0.20	0.20 ~ 1.5																				● 2433	
	VBGT 160404 - SF	0.4	0.05 ~ 0.20	0.20 ~ 2.0																				● 2358	
-UF Finishing	VBMT 110304 - UF	0.4	0.04 ~ 0.16	0.10 ~ 0.8						● 2697															
	VBMT 110308 - UF	0.4								● 2698															
	VBMT 160404 - UF	0.4	0.05 ~ 0.25	0.50 ~ 2.0			○ 0294			● 2364	● 0295	● 0296													
	VBMT 160408 - UF	0.8	0.05 ~ 0.25	0.80 ~ 2.0			○ 0300			● 2216	● 0301	● 0302													
-UG General	VBMT 160404 - UG	0.4	0.15 ~ 0.30	0.50 ~ 2.5	● 1842	○ 0682	○ 0297		● 2181	● 0298	● 0299	○ 0047													
	VBMT 160408 - UG	0.8	0.15 ~ 0.30	0.80 ~ 2.5	● 1843	○ 0681	○ 0303		● 2211	● 0304	● 0305	● 0048													
NEW -MF Stainless steel Finishing	VBMT 160402 - MF	0.2	0.04 ~ 0.15	0.10 ~ 2.0													● 2510	● 2008	● 2009	● 2010	● 2036				
	VBMT 160404 - MF	0.4	0.05 ~ 0.20	0.20 ~ 2.0														● 2511	● 1960	● 1961	● 1962	● 2037			
	VBMT 160408 - MF	0.8	0.07 ~ 0.27	0.30 ~ 2.0														● 2512	● 2011	● 2012	● 2013	● 2038			
NEW -MM Stainless steel Medium	VBMT 160404 - MM	0.4	0.07 ~ 0.21	0.25 ~ 2.7													● 2522	● 1996	● 1997	● 1998	● 2044				
	VBMT 160408 - MM	0.8	0.08 ~ 0.27	0.50 ~ 2.7														● 2523	● 1987	● 1988	● 1989	● 2045			
NEW -PF Cermet Medium	VBMT 160402 - PF	0.2	0.04 ~ 0.15	0.10 ~ 2.0																				● 2550	
	VBMT 160404 - PF	0.4	0.05 ~ 0.20	0.20 ~ 2.0																				● 2551	
	VBMT 160408 - PF	0.8	0.07 ~ 0.27	0.30 ~ 2.0																				● 2552	
NEW -PM Cermet Medium	VBMT 160404 - PM	0.4	0.07 ~ 0.21	0.25 ~ 2.7																				● 2561	
	VBMT 160408 - PM	0.8	0.08 ~ 0.27	0.50 ~ 2.7																				● 2562	

Turning Inserts - Positive



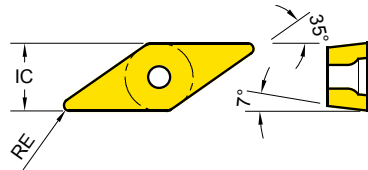



VCGT / VCMT (35° Rhombic)



Series	IC	S
VC** 1103	6.350	3.18
VC** 1604	9.525	4.76

EDP 2200..

● : Stock item ○ : Order made item

VCGT VCMT	Designation	RE	Fn (mm/rev.)	Ap (mm)	K10	P05	P10	P15	P10	P20	P30	P20	M25	M15	M30	M40	S10	P15	P15	N20	N20		
					YG1010	YG1001	YG3010	YG3015	YG3115	YG3020	YG3030	YG801	YG2025	YG211	YG213	YG214	YG401	YT100	YG100	YG10			
-AL  Aluminum	VCGT 110301 - AL	0.1	0.02 ~ 0.20	0.2 ~ 2.0																	●	●	
	VCGT 110302 - AL	0.2	0.02 ~ 0.20	0.2 ~ 2.0																		●	●
	VCGT 110304 - AL	0.4	0.05 ~ 0.25	0.2 ~ 3.0																		●	●
	VCGT 160402 - AL	0.2	0.02 ~ 0.05	0.5 ~ 1.0																		●	●
	VCGT 160404 - AL	0.4	0.05 ~ 0.25	0.5 ~ 2.0																		●	●
	VCGT 160408 - AL	0.8	0.10 ~ 0.35	1.0 ~ 3.0																		●	●
	VCGT 160412 - AL	1.2	0.10 ~ 0.35	1.2 ~ 3.0																		●	●
-SF  HRSA Finishing	VCGT 110301 - SF	0.1	0.01 ~ 0.20	0.1 ~ 1.5																	●	●	
	VCGT 110302 - SF	0.2	0.02 ~ 0.20	0.1 ~ 1.5													○	○				●	●
	VCGT 110304 - SF	0.4	0.05 ~ 0.20	0.2 ~ 1.5																		●	●
	VCGT 110308 - SF	0.8	0.05 ~ 0.20	0.4 ~ 1.5																		●	●
-UF  Finishing	VCMT 160404 - UF	0.4	0.05 ~ 0.25	0.5 ~ 2.0			○						●	●	●								
	VCMT 160408 - UF	0.8	0.05 ~ 0.25	1.0 ~ 2.0			○						●	●									
-UG  General	VCMT 160404 - UG	0.4	0.10 ~ 0.20	0.3 ~ 2.5																	○	○	
	VCMT 160408 - UG	0.8	0.15 ~ 0.30	0.8 ~ 2.5	●	○							●	●	●	○							
-MF  Stainless steel Finishing	VCMT 110304 - MF	0.4	0.05 ~ 0.20	0.1 ~ 1.7																	●	●	
-PF  Cermet Medium	VCMT 110304 - PF	0.4	0.05 ~ 0.20	0.1 ~ 1.7																	●	●	

External Holders Overview

Click/Touch each page number and move to the very page!











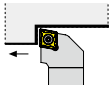
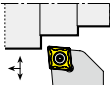

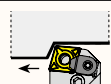





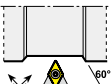

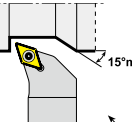

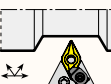
TURNING

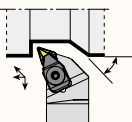
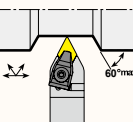
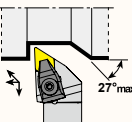
PARTING & GROOVING

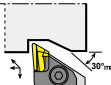
MILLING

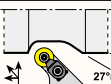
DRILLING

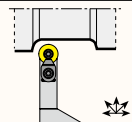
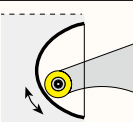
TECHNICAL INFORMATION

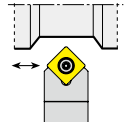
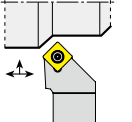
Series		Turning Holder				
	CCGT CCMT	 SCACR/L Screw	 SCLCR/L Screw			
Page	57	86	86			
	CNMA CNMG	 PCBNR/L Lever	 PCLNR/L Lever (+Clamp)	 TCLNR/L Double Clamp	 TCBNR/L Double Clamp	 TCKNR/L Double Clamp
Page	30	72	72	77	77	77
	DCGT DCMT	 SDNCN Screw	 SDJCR/L Screw	 SDHCR/L Screw		
Page	59	87	87	87		
	DNMA DNMG	 PDNNN Lever (+Clamp)	 PDJNR/L Lever (+Clamp)	 TDHNR/L Double Clamp	 TDNNN Double Clamp	 TDJNR/L Double Clamp
Page	35	73	73	78	78	78
	KNUX	 CKJNR/L Top Clamp				
Page	41	79				
	RCMT	 SRGCR/L Screw	 SRDCN Screw	 SRDCN Screw	 SRHCN Screw	
Page	61	88	88	88	88	
	SCGT SCMT	 SSDCN Screw	 SSSCR/L Screw			
Page	63	89	89			

Turning - Holder - External

External Holders Overview

Click/Touch each page number and move to the very page!

Series		Turning Holder						
	SNMA SNMG							
		PSDNN Lever (+Clamp)	PSSNR/L Lever (+Clamp)	PSBNR/L Lever (+Clamp)	PSKNR/L Lever (+Clamp)	TSDNN Double Clamp	TSSNR/L Double Clamp	TSKNR/L Double Clamp
		Page 42	74	74	74	74	80	80
	TCGT TCMT							
		STFCR/L Screw	STGCR/L Screw	STJCR/L Screw	STUCR/L Screw			
		Page 64	p. 90	p. 90	p. 90	p. 90		
	TNMA TNMG TNUX							
		PTTNR/L Lever (+Clamp)	PTFNR/L Lever (+Clamp)	PTGNR/L Lever (+Clamp)	PTJNR/L Lever (+Clamp)	TTGNR/L Double Clamp	TTJNR/L Double Clamp	MTJNR/L Multi-Clamp
		Page 47	75	75	75	75	81	81
	VBMT							
		SVHBR/L Screw	SVVBN Screw	SVJBR/L Screw				
		Page 66	91	91	91			
	VCGT VCMT							
		SVHCR/L Screw	SVVCN Screw	SVJCR/L Screw				
		Page 67	92	92	92			
	VNMA VNMG							
		TVVNN Double Clamp	TVJNR/L Double Clamp	TVHNR/L Double Clamp				
		Page 51	82	82	82			
	WNMA WNMG							
		PWLNR/L Lever (+Clamp)	TWLNR/L Double Clamp	MWLNR/L Multi-Clamp				
		Page 53	76	83	85			

Internal Holders Overview

Click/Touch each page number and move to the very page!











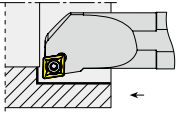
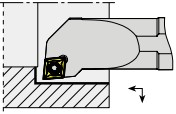
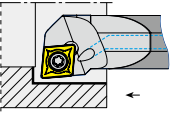

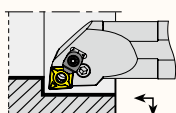
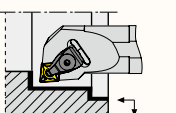
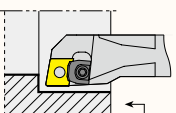
TURNING

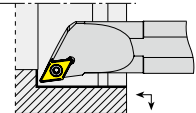
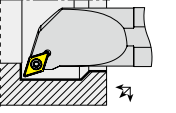
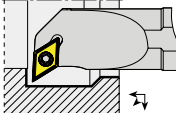
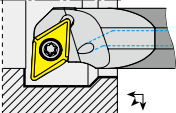
PARTING & GROOVING

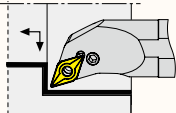
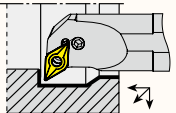
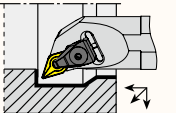
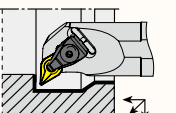
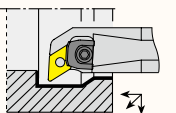
MILLING

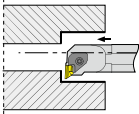
DRILLING

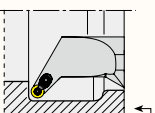

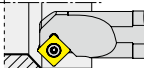







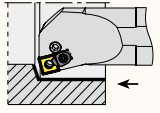
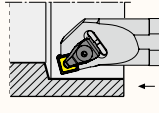

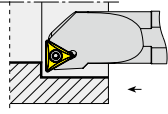
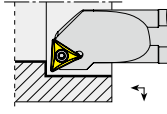
TECHNICAL INFORMATION

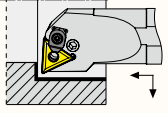
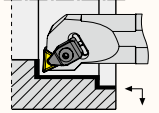
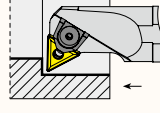
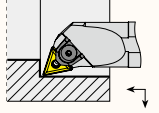
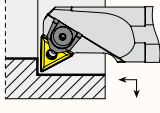
Series		Turning Holder				
	CCGT CCMT					
		..-SCFCR/L Screw	..-SCLCR/L Screw	E..-SCLCR/L Screw		
Page	57	108	109	109		
	CNMA CNMG					
		..-PCLNR/L Lever (+Clamp)	..-TCLNR/L Double Clamp	..-MCLNR/L Multi-Clamp		
Page	30	93	98	104		
	DCGT DCMT					
		..-SDPCR/L Screw	..-SDQCR/L Screw	..-SDUCR/L Screw	E..-SDUCR/L Screw	
Page	59	110	110	111	111	
	DNMA DNMG					
		..-PDQNR/L Lever (+Clamp)	..-PDUNR/L Lever (+Clamp)	..-TDQNR/L Double Clamp	..-TDUNR/L Double Clamp	..-MDUNR/L Multi-Clamp
Page	35	94	94	99	99	104
	KNUX					
		..-CKUNR/L Top Clamp				
Page	41	107				
	RCMT					
		..-SRGCR-L Screw Type				
Page	61	112				
	SCGT SCMT					
		..-SSSCR/L Screw Type				
Page	63	113				

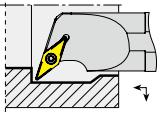
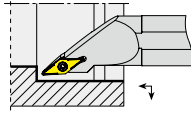
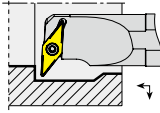
Turning - Holder - Internal

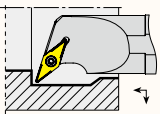
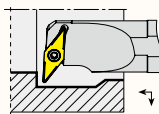
Internal Holders Overview

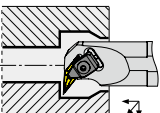
Click/Touch each page number and move to the very page!

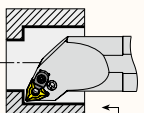
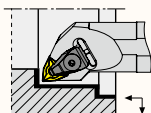
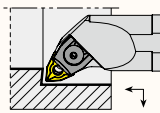
Series		Turning Holder				
	SNMA SNMG					
		..PSKNR/L Lever (+Clamp)	..TSKNR/L Double Clamp			
Page	42	95	100			
	TCGT TCMT					
		..STFCR/L Screw	..STUCR/L Screw			
Page	64	114	114			
	TNMA TNMG TNUX					
		..PTUNR/L Lever (+Clamp)	..TTUNR/L Double Clamp	..MTFNR/L Pin + Clamp	..MTQNR/L Multi-Clamp	..MTUNR/L Pin + Clamp
Page	47	96	101	105	105	105
	VBMT					
		..SVQBR/L Screw	..SVJBR/L Screw	..SVUBR/L Screw		
Page	66	115	115	115		
	VCGT VCMT					
		..SVQCR/L Screw	..SVUCR/L Screw			
Page	67	116	116			
	VNMA VNMG					
		..TVUNR/L Double Clamp				
Page	51	102				
	WNMA WNMG					
		..PWLNR/L Lever (+Clamp)	..TWLNR/L Double Clamp	..MWLNR/L Multi-Clamp		
Page	53	97	103	106		

Turning - Holder - External

Lever Lock type for CN Insert**

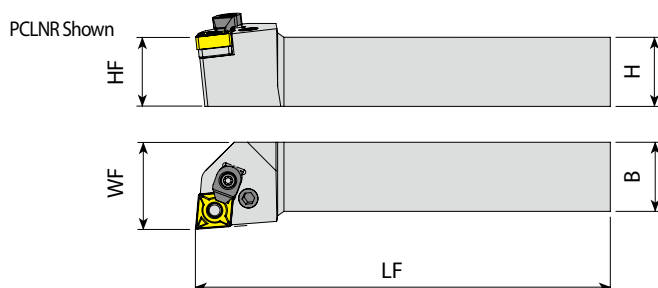

* 'C' Letter at Last : Optional Clamp Included

: p. 30

Unit:mm

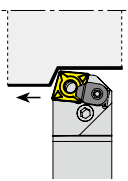
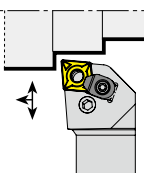
Series	Designation	EDP 2700.. R	L	H (= HF)	B	WF	LF	Insert
 <p>PCBNR/L Approach angle 75°</p>	PCBNR/L 2020K 12C	0438	0439	20	20	17.5	125	CN1204
	PCBNR/L 2525M 12C	0440	0441	25	25	22.5	150	
	PCBNR/L 3232P 12C	0442	0443	32	32	29.5	170	CN1606
	PCBNR/L 2525M 16C	0444	0445	25	25	22.0	150	
	PCBNR/L 3232P 16C	0446	0447	32	32	27.0	170	CN1906
	PCBNR/L 3232P 19C	0448	0449	32	32	37.0	170	
	PCBNR/L 4040S 19C	0450	0451	40	40	37.0	250	
 <p>PCLNR/L Approach angle 95°</p>	PCLNR/L 1616-H09	0001	0002	16	16	20.0	100	CN0903
	PCLNR/L 1616H 12	0464	0465	16	16	20.0	100	CN1204
	PCLNR/L 2020K 12C	0466	0467	20	20	25.0	125	
	PCLNR/L 2525M 12C	0468	0469	25	25	32.0	150	
	PCLNR/L 3232P 12C	0470	0471	32	32	40.0	170	CN1606
	PCLNR/L 2525M 16C	0472	0473	25	25	32.0	150	
	PCLNR/L 3232P 16C	0474	0475	32	32	40.0	170	CN1906
	PCLNR/L 2525M 19C	0476	0477	25	25	32.0	150	
	PCLNR/L 3232P 19C	0478	0479	32	32	40.0	170	
	PCLNR/L 4040S 19C	0480	0481	40	40	50.0	250	

Series	Designation	Infomation	Lever	Lever Screw	Clamp	Clamp Screw	Shim	Shim Pin	Allen Key
H09	Descritpion	YAPL-01	YALV-02-M6x17	-	-	YAACN-2-0002	YAAY-01	YAAL-02-2.5	
	EDP	18000092	18000099			28000028	18000053	18000060	
..12	Descritpion	YAPL-02	YALV-03-M8x19	-	-	YAACN-3-0001	YAAY-02	YAAL-03-3	
	EDP	18000093	18000100			18000137	18000054	18000061	
PC.. ..12C	Descritpion	YAPL-02	YALV-03-M8x19	YACK-05	Y4015-M4x11	YAACN-3-0001	YAAY-02	YAAL-03-3	
	EDP	18000093	18000100	18000065	18000119	18000137	18000054	18000061	
..16C	Descritpion	YAPL-04	YALV-04-M8x22	YACK-09	YAAV-05-M6x15	YAACN-3-0002	YAAY-03	YAAL-03-3	
	EDP	18000095	18000101	18000066	18000078	18000138	18000055	18000061	
..19C	Descritpion	YAPL-05	YALV-05-M10x27	YACK-09	YAAV-05-M6x15	YAACN-3-0003	YAAY-04	YAAL-05-4	
	EDP	18000096	18000102	18000066	18000078	18000139	18000056	18000062	

Turning - Holder - External

Lever Lock type for DN** Insert

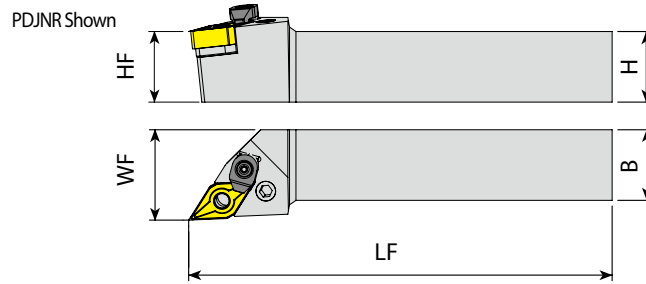

* 'C' Letter at Last : Optional Clamp Included

: p. 35

Unit: mm

Series	Designation	EDP 2700.. R	L	H (= HF)	B	WF	LF	Insert
<p>PDNNN Approach angle 62.5°</p>	PDNNN 2020K 15C	0515		20	20	10.0	125	DN1506
	PDNNN 2525M 15C	0516		25	25	12.5	150	
	PDNNN 3232P 15C	0517		32	32	16.0	170	
<p>PDJNR/L Approach angle 93°</p>	PDJNR/L 1616-H11	0031	0032	16	16	20.0	100	DN1104
	PDJNR/L 2020K 15C	0500	0501	20	20	25.0	125	DN1506
	PDJNR/L 2525M 15C	0502	0503	25	25	32.0	150	
	PDJNR/L 3232P 15C	0504	0505	32	32	40.0	170	
	PDJNR/L 4040S 15C	1734	0506	40	40	50.0	250	

Series	Designation	Information	Lever	Lever Screw	Clamp	Clamp Screw	Shim	Shim Pin	Allen Key
PD..	..15C	Description	YAPL-03	YALV-03-M8x19	YACK-05	Y4015-M4x11	YAADN-3-0001	YAAY-02	YAAL-03-3
		EDP	18000094	18000100	18000065	18000119	18000137	18000054	18000061
	..H11	Description	YAPL-01	YALV-02-M6x17	-	-	YAADN-SD317	YAAY-01	YAAL-02-2.5
		EDP	18000092	18000099	-	-	28000029	18000053	18000060
	..M15	Description	YAPL-03	YALV-03-M8x19	YACK-05	Y4015-M4x11	YAADN-3-0001	YAAY-02	YAAL-03-3
		EDP	18000094	18000100	18000065	18000119	18000137	18000054	18000061

Turning - Holder - External

Lever Lock type for SN** Insert

PSKNR Shown

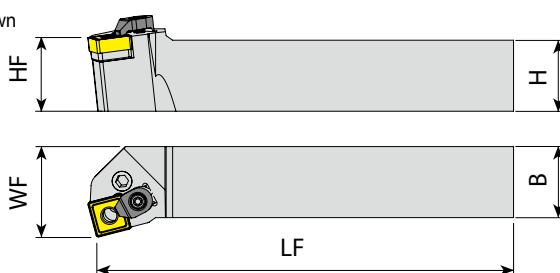

* 'C' Letter at Last : Optional Clamp Included

: p. 32

Unit:mm

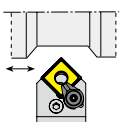
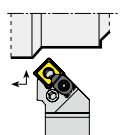
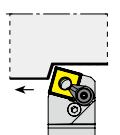
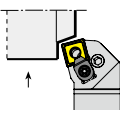
Series	Designation	EDP 2700.. R	L	H (= HF)	B	WF	LF	Insert
 <p>PSDNN Approach angle 45°</p>	PSDNN 1616-H09	0075		16	16	8.0	100	SN0903
	PSDNN 2020K 12C	0530		20	20	10.0	125	SN1204
	PSDNN 2525M 12C	0531		25	25	12.5	150	
	PSDNN 3232P 12C	0532		32	32	16.0	170	
 <p>PSSNR/L Approach angle 45°</p>	PSSNR/L 1616-H09	0079	0080	16	16	20.0	100	SN0903
	PSSNR/L 2020K 12C	0548	0549	20	20	25.0	125	SN1204
	PSSNR/L 2525M 12C	0550	0551	25	25	32.0	150	
	PSSNR/L 3232P 12C	0552	0553	32	32	40.0	170	
 <p>PSBNR/L Approach angle 75°</p>	PSBNR/L 1616-H09	0069	0070	16	16	13.0	100	SN0903
	PSBNR/L 2020K 12	0430	0525	20	20	17.0	125	SN1204
	PSBNR/L 2525M 12C	0526	0527	25	25	22.0	150	
	PSBNR/L 3232P 12C	0528	0529	32	32	27.0	170	
 <p>PSKNR/L Approach angle 75°</p>	PSKNR/L 2020K 12C	0537		20	20	25.0	125	SN1204
	PSKNR/L 2525M 12C	0538	0539	25	25	32.0	150	
	PSKNR/L 3232P 12C	0540	0541	32	32	40.0	170	

Series	Designation	Infomation	Lever	Lever Screw	Clamp	Clamp Screw	Shim	Shim Pin	Allen Key
PS..	..H09	Descriptipn	YAPL-01	YALV-02-M6x17	-	-	YAASN-2-0002	YAAY-01	YAAL-02-2.5
		EDP	18000092	18000099			28000028	18000053	18000060
	..12	Descriptipn	YAPL-02	YALV-03-M8x19	-	-	YAASN-3-0004	YAAY-02	YAAL-03-3
		EDP	18000093	18000100			18000145	18000054	18000060
	..12C	Descriptipn	YAPL-02	YALV-03-M8x19	YACK-05	Y4015-M4x11	YAASN-3-0004	YAAY-02	YAAL-03-3
		EDP	18000093	18000100	18000065	18000119	18000145	18000054	18000060

Turning - Holder - External

Lever Lock type for TN** Insert

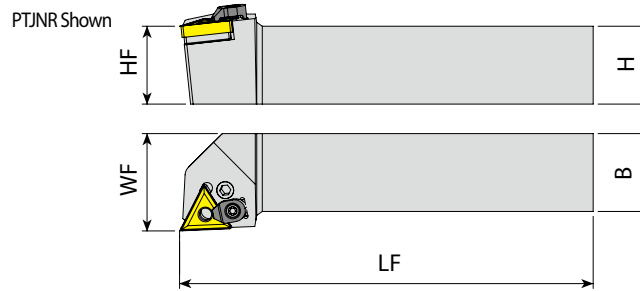

* 'C' Letter at Last : Optional Clamp Included

 : p. 47

Unit: mm

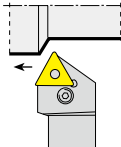
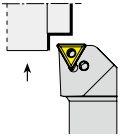
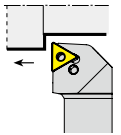
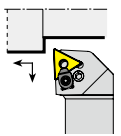
Series	Designation	EDP 2700.. R	EDP 2700.. L	H (= HF)	B	WF	LF	Insert
 PTTNR/L Approach angle 60°	PTTNR/L 1616H 16	0619	0620	16	16	13.0	100	TN1604
	PTTNR/L 2020K 16	0429	0621	20	20	17.0	125	
	PTTNR/L 2525M 16	0622	0623	25	25	21.5	150	
	TN2204	PTTNR/L 2525M 22C	0626	0627	25	25	20.5	150
		PTTNR/L 3232P 16	0624	0625	32	32	31.0	170
		PTTNR/L 3232P 22C	0628	0629	32	32	29.0	170
 PTFNR/L Approach angle 91°	PTFNR/L 1616H 16	0560	0561	16	16	20.0	100	TN1604
	PTFNR/L 2020K 16	0049	0050	20	20	25.0	125	
	PTFNR/L 2525M 16	0051	0052	25	25	32.0	150	
	TN2204	PTFNR/L 2525M 22C	0564	0565	25	25	32.0	150
		PTFNR/L 3232P 16	0562	0563	32	32	40.0	170
		PTFNR/L 3232P 22C	0566	0567	32	32	40.0	170
 PTGNR/L Approach angle 91°	PTGNR/L 1616H 16	0568	0569	16	16	20.0	100	TN1604
	PTGNR/L 2020K 16	0055	0056	20	20	25.0	125	
	TN2204	PTGNR/L 2525M 16	0057	0058	25	25	32.0	150
		PTGNR/L 2525M 22C	0570	0571	25	25	32.0	150
		PTGNR/L 3232P 22C	0572	0573	32	32	40.0	170
 PTJNR/L Approach angle 93°	PTJNR/L 1616H 16	0597	0598	16	16	20.0	100	TN1604
	PTJNR/L 2020K 16	0599	0600	20	20	25.0	125	
	PTJNR/L 2525M 16	0601	0602	25	25	32.0	150	
	TN2204	PTJNR/L 3232P 16	0603	0604	32	32	40.0	170
		PTJNR/L 2525M 22C	0605	0606	25	25	32.0	150
		PTJNR/L 3232P 22C	0607	0608	32	32	40.0	170

Series	Designation	Information	Lever	Lever Screw	Clamp	Clamp Screw	Shim	Shim Pin	Allen Key
PT..	..16	Description	YAPL-01	YALV-02-M6x17	-	-	YAATN-3-0025	YAAY-01	YAAL-02-2.5
		EDP	18000092	18000099	-	-	18000149	18000053	18000060
	..22..	Description	YAPL-02	YALV-03-M8x19	YACK-05	Y4015-M4x11	YAATN-3-0015	YAAY-02	YAAL-03-3
		EDP	18000093	18000100	18000065	18000119	18000148	18000054	18000061

Lever Lock type for WN** Insert

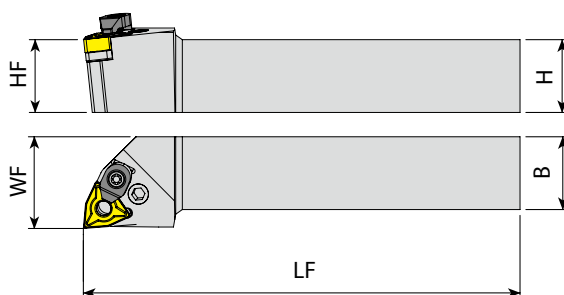

* 'C' Letter at Last : Optional Clamp Included

: p. 53

Unit:mm

Series	Designation	EDP 2700..		H (= HF)	B	WF	LF	Insert
		R	L					
PWLNR/L	PWLNR/L 1616H 06	0647	0648	16	16	20	100	WN0604
	PWLNR/L 2020K 06	0649	0650	20	20	25	125	
	PWLNR/L 2525M 06	0651	0652	25	25	32	150	
PWLNR/L	PWLNR/L 1616H 08	0653	0654	16	16	20	100	WN0804
	PWLNR/L 2020K 08C	0655	0656	20	20	25	125	
	PWLNR/L 2525M 08C	0657	0658	25	25	32	150	
	PWLNR/L 3232P 08C	0659	0660	32	32	40	170	

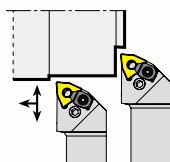

PWLNR/L

Approach angle
95°

Series	Designation	Infomation	Lever	Lever Screw	Clamp	Clamp Screw	Shim	Shim Pin	Allen Key
PW..	..06	Descritpion	YAPL-01	YALV-02-M6x17	-	-	YAAWN-SW317	YAAY-01	YAAL-02-2.5
		EDP	18000092	18000099	-	-	18000152	18000053	18000060
	..08	Descritpion	YAPL-02	YALV-03-M8x19	-	-	YAAWN-3-0001	YAAY-02	YAAL-03-3
		EDP	18000093	18000100	-	-	18000151	18000054	18000061
	..08C	Descritpion	YAPL-02	YALV-03-M8x19	YACK-05	Y4015-M4x11	YAAWN-3-0001	YAAY-02	YAAL-03-3
		EDP	18000093	18000100	18000065	18000119	18000151	18000054	18000061

Turning - Holder - External

Double Clamp type for CN** Insert

TCLNR Shown

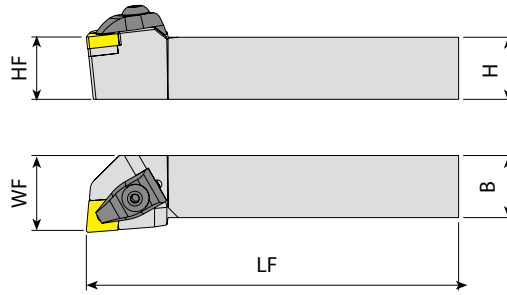

* 'C' Letter at Last : Optional Clamp Included

 : p. 30

Unit: mm

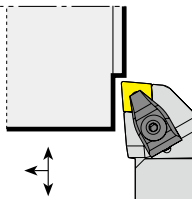
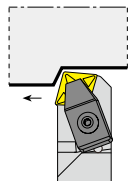
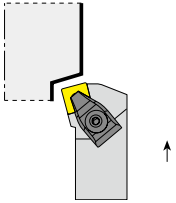
Series	Designation	EDP 2700..		H (= HF)	B	WF	LF	Insert
		R	L					
 <p>TCLNR/L Approach angle 95°</p>	TCLNR/L 2020K 12	0482	0483	20	20	25	125	CN1204
	TCLNR/L 2525M 12	0484	0485	25	25	32	150	
	TCLNR/L 3232P 12	0486	0487	32	32	40	170	
	TCLNR/L 4040S 12	0488	0489	40	40	50	250	
	TCLNR/L 5050S 12	0490	0491	50	50	63	250	
	TCLNR/L 2525M 16	0492	0493	25	25	32	150	CN1606
TCLNR/L 3232P 16	0494	-	32	32	40	170		
 <p>TCBNR/L Approach angle 75°</p>	TCBNR/L 2525M 16	0452	0453	25	25	22	150	CN1606
 <p>TCKNR/L Approach angle 75°</p>	TCKNR/L 2020K 12	0454	0455	20	20	25	125	CN1204
	TCKNR/L 2525M 12	0456	0457	25	25	32	150	
	TCKNR/L 3232P 12	0458	0459	32	32	40	170	
	TCKNR/L 2525M 16	0460	0461	25	25	32	150	CN1606
	TCKNR/L 3232P 16	0462	0463	32	32	40	170	

Series	Designation	Information	Clamp	Clamp Screw	Upper Ring	Lower Ring	Shim	Shim Screw	Allen Key
TC..	..12	Description	YATK-02	YAKV-30-M6x22	YABPL-01	YAS-01	YAACN-3-0001	YAAV-02-M5x12	YAAL-03-3
		EDP	18000075	18000091	18000058	18000052	18000137	18000156	18000061
	..16	Description	YATK-04	YAKV-19-M7x25	YABPL-02	YAS-02	YAACN-3-0002	YAAV-05-M6x15	YAAL-05-4
		EDP	18000077	18000088	18000059	28000042	18000138	18000078	18000062

Double Clamp type for DN Insert**

TDJNR Shown

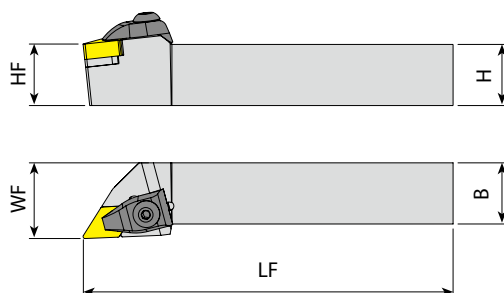

* 'C' Letter at Last : Optional Clamp Included

: p. 35 Unit:mm

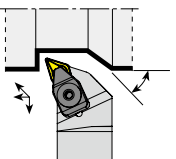
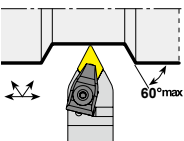
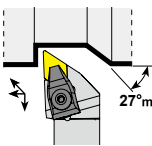
Series	Designation	EDP 2700..		H (= HF)	B	WF	LF	Insert	
		R	L						
 TDHNR/L Approach angle 107.5°	TDHNR/L 2020K 15	0495	0496	20	20	25.0	125	DN1506	
	TDHNR/L 2525M 15	0497	0498	25	25	32.0	150		
	TDHNR 3232P 15	0499	-	32	32	40.0	170	DN1504	
 TDNNN Approach angle 62.5°	TDNNN 2020K 15		0518	20	20	10.0	125	DN1506	
	TDNNN 2525M 15		0519	25	25	12.5	150		
	TDNNN 3232P 15		0520	32	32	16.0	170		
 TDJNR/L Approach angle 93°	TDJNR/L 2020K 15		0507	0508	20	20	25.0	125	DN1506
	TDJNR/L 2525M 15		0509	0510	25	25	32.0	150	
	TDJNR/L 3232P 15		0511	0512	32	32	40.0	170	
	TDJNR/L 4040S 15		0513	0514	40	40	50.0	250	

Series	Designation	Information	Clamp	Clamp Screw	Upper Ring	Lower Ring	Shim	Shim Screw	Allen Key
TD..	..15	Description	YATK-02	YAKV-30-M6x22	YABPL-01	YAS-01	YAADN-3-0001	YAAV-02-M5x12	YAAL-03-3
		EDP	18000075	18000091	18000058	18000052	18000142	18000156	18000061

Turning - Holder - External

Top Clamp type for KN** Insert

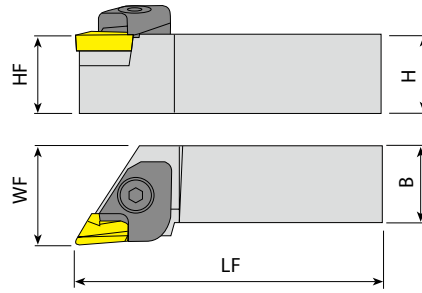

: p. 41

Unit:mm

Series	Designation	EDP 2700..		H (= HF)	B	WF	LF	Insert
		R	L					
<p>CKJNR/L Approach angle 93°</p>	CKJNR/L 2020K 16	0521	0522	20	20	27.5	125	KNUX1604
	CKJNR/L 2525M 16	0152	0153	25	25	31.5	150	
	CKJNR/L 3232P 16	0154	0155	32	32	40.0	170	
	CKJNR/L 4040S 16	0523	0524	40	40	50.0	250	

Series	Designation	Information	Clamp	Clamp Screw	Spring	Upper Ring	Shim	Shim Screw	Allen Key
CK..	..16	Description	YACK-01-R	YAKV-06-M6x20	YAKY-02	YABPL-01	YAKS-16-R	YAAV-01-M3x10	YAAL-05-4
		EDP	18000064	18000083	18000164	18000058	18000154	18000155	18000062
	..16	Description	YACK-02-L	YAKV-06-M6x20	YAKY-02	YABPL-01	YAKS-16-L	YAAV-01-M3x10	YAAL-05-4
		EDP	18000063	18000083	18000164	18000058	18000153	18000155	18000062

Turning - Holder - External

Double Clamp type for SN Insert**

TSSNR Shown

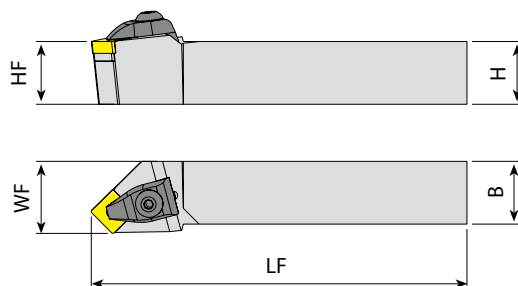

* 'C' Letter at Last : Optional Clamp Included

: p. 42 Unit:mm

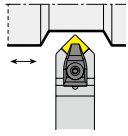
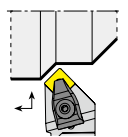
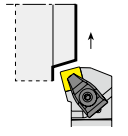
Series	Designation	EDP 2700.. R	L	H (= HF)	B	WF	LF	Insert
 TSDNN Approach angle 45°	TSDNN 1616H 12	0533		16	16	8.0	100	SN1204
	TSDNN 2020K 12	0534		20	20	10.0	125	
	TSDNN 2525M 12	0535		25	25	12.5	150	
	TSDNN 3232P 12	0536		32	32	16.0	170	
 TSSNR/L Approach angle 45°	TSSNR/L 2020K 12	0554	0555	20	20	25.0	125	SN1204
	TSSNR/L 2525M 12	0556	0557	25	25	32.0	150	
	TSSNR/L 3232P 12	0558	0559	32	32	40.0	170	
 TSKNR/L Approach angle 75°	TSKNR/L 2020K 12	0542	0543	20	20	25.0	125	SN1204
	TSKNR/L 2525M 12	0544	0545	25	25	32.0	150	
	TSKNR/L 3232P 12	0546	0547	32	32	40.0	170	

Series	Designation	Infomation	Clamp	Clamp Screw	Upper Ring	Lower Ring	Shim	Shim Screw	Allen Key
TS..	..12	Description	YATK-02	YAKV-30-M6x22	YABPL-01	YAS-01	YAASN-3-0004	YAAV-02-M5x12	YAAL-03-3
		EDP	18000075	18000091	18000058	18000052	18000145	18000156	18000061

Turning - Holder - External

Double Clamp type for TN** Insert

TTJNR Shown

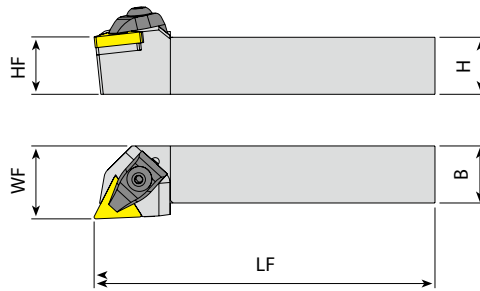

* 'C' Letter at Last : Optional Clamp Included

: p. 47

Unit: mm

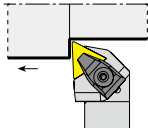
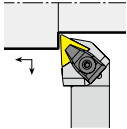
Series	Designation	EDP 2700..		H (= HF)	B	WF	LF	Insert	
		R	L						
 <p>TTGNR/L Approach angle 91°</p>	TTGNR/L 2020K 16	0574	0575	20	20	25	125	TN1604	
	TTGNR/L 2525M 16	0576	0577	25	25	32	150		
	TTGNR/L 3232P 16	0578	0579	32	32	40	170		
	 <p>TTJNR/L Approach angle 93°</p>	TTGNR/L 2525M 22	0580	0581	25	25	32	150	TN2204
		TTGNR/L 3232P 22	0582	0583	32	32	40	170	
		TTGNR/L 4040S 22	0584	-	40	40	50	250	
TTJNR/L 2020K 16		0609	0610	20	20	25	125		
TTJNR/L 2525M 16		0611	0612	25	25	32	150		
	TTJNR/L 3232P 16	0613	0614	32	32	40	170	TN1604	
	TTJNR/L 2525M 22	0615	0616	25	25	32	150		
	TTJNR/L 3232P 22	0617	0618	32	32	40	170	TN2204	

Series	Designation	Information	Clamp	Clamp Screw	Upper Ring	Lower Ring	Shim	Shim Screw	Allen Key
TT..	..16	Description	YATK-01	YAKV-01-M5x22	YABPL-01	-	YAATN-2-0002	YAAV-03-M5x12	YAAL-03-3
		EDP	18000074	18000080	18000058	-	18000147	18000157	18000061
	..22	Description	YATK-02	YAKV-30-M6x22	YABPL-01	YAS-01	YAATN-3-0015	YAAV-02-M5x12	YAAL-03-3
		EDP	18000075	18000091	18000058	18000052	18000148	18000156	18000061

Turning - Holder - External

Double Clamp type for VN Insert**

TVJNR Shown

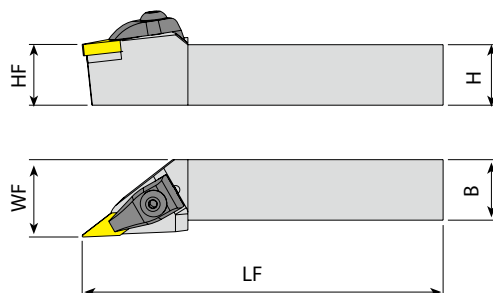

: p.51 Unit:mm

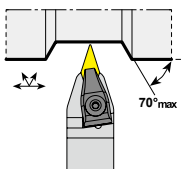
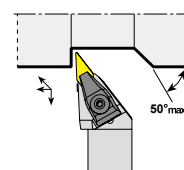
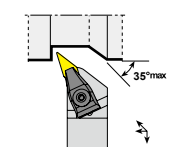
Series	Designation	EDP 2700.. R	L	H (= HF)	B	WF	LF	Insert
 <p>TVVNN Approach angle 72.5°</p>	TVVNN 2020K 16	0642		20	20	10.0	125	VN1604
	TVVNN 2525M 16	0643		25	25	12.5	150	
	TVVNN 3232P 16	0644		32	32	16.0	170	
 <p>TVJNR/L Approach angle 93°</p>	TVJNR/L 2020K 16	0636	0637	20	20	25.0	125	VN1604
	TVJNR/L 2525M 16	0638	0639	25	25	32.0	150	
	TVJNR/L 3232P 16	0640	0641	32	32	40.0	170	
 <p>TVHNR/L Approach angle 107.5°</p>	TVHNR/L 2020K 16	0630	0631	20	20	25.0	125	VN1604
	TVHNR/L 2525M 16	0632	0633	25	25	32.0	150	
	TVHNR/L 3232P 16	0634	0635	32	32	40.0	170	

Series	Designation	Infomation	Clamp	Clamp Screw	Upper Ring	Lower Ring	Shim	Shim Screw	Allen Key
TV..	..16	Description	YATK-03	YAKV-30-M6x22	YABPL-01	YAS-01	YAAVN-2-0002	YAAV-04-M5x12	YAAL-03-3
		EDP	18000076	18000091	18000058	18000052	18000150	18000158	18000061

Turning - Holder - External

Double Clamp type for WN** Insert

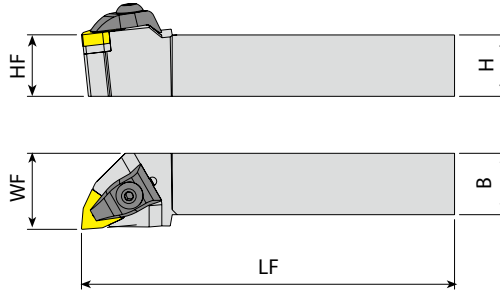

* 'C' Letter at Last : Optional Clamp Included

: p.53

Unit:mm

Series	Designation	EDP 2700..		H (= HF)	B	WF	LF	Insert
		R	L					
TWLNR/L	TWLNR/L 1616H 06	0661	0662	16	16	20	100	WN0604
	TWLNR/L 2020K 06	0663	0664	20	20	25	125	
	TWLNR/L 2525M 06	0665	0666	25	25	32	150	
TWLNR/L	TWLNR/L 2020K 08	0667	0668	20	20	25	125	WN0804
	TWLNR/L 2525M 08	0669	0670	25	25	32	150	
	TWLNR/L 3232P 08	0671	0672	32	32	40	170	
	TWLNR/L 4040S 08	0673	0674	40	40	50	250	

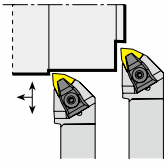

TWLNR/L

Approach angle
95°

Series	Designation	Information	Clamp	Clamp Screw	Upper Ring	Lower Ring	Shim	Shim Screw	Allen Key
TW..	..06	Description	YATK-01	YAKV-01-M5x22	YABPL-01	-	YAAWN-SW317	YAAV-01-M3x10	YAAL-03-3
		EDP	18000074	18000080	18000058	-	18000152	18000155	18000061
	..08	Description	YATK-02	YAKV-30-M6x22	YABPL-01	YAS-01	YAAWN-3-0001	YAAV-02-M5x12	YAAL-03-3
		EDP	18000075	18000091	18000058	18000052	18000151	18000156	18000061

Turning - Holder - External

Multi-Clamp type for TN** Insert

TURNING

PARTING & GROOVING

MILLING

DRILLING

TECHNICAL INFORMATION

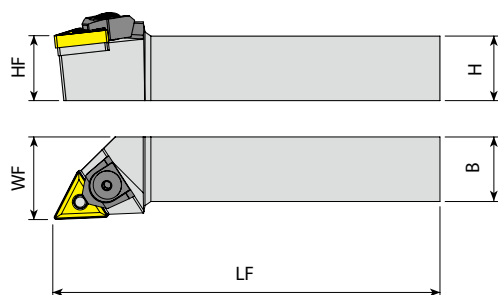

* 'C' Letter at Last : Optional Clamp Included

: p. 47 Unit:mm

Series	Designation	EDP 2700..		H (= HF)	B	WF	LF	Insert
		R	L					
 <p>MTJNR/L Approach angle 93°</p>	MTJNR/L 2020K 16	0585	0586	20	20	25	125	TN1604
	MTJNR/L 2525M 16	0587	0588	25	25	32	150	
	MTJNR/L 3232P 16	0589	0590	32	32	40	170	
	MTJNR/L 2525M 22	0591	0592	25	25	32	150	TN2204
	MTJNR/L 3232P 22	0593	0594	32	32	40	170	
	MTJNR/L 4040S 22	0595	0596	40	40	50	250	

Series	Designation	Infomation	Clamp	Clamp Screw	Upper Ring	Lower Ring	Pin	Shim	Allen Key
MT..	..16	Descritpion	YAMK-04	YAKV-30-M6x22	YABPL-01	YAS-01	YAPM-01	YAATN-2-0002	YAAL-03-3
		EDP	18000072	18000091	18000058	18000052	18000110	18000147	18000061
	..22	Descritpion	YAMK-04	YAKV-30-M6x22	YABPL-01	YAS-01	YAPM-02	YAATN-3-0015	YAAL-03-3
		EDP	18000072	18000091	18000058	18000052	18000111	18000148	18000061

Turning - Holder - External

Multi-Clamp type for WN** Insert

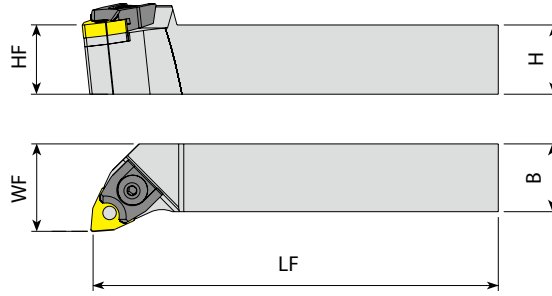

* 'C' Letter at Last : Optional Clamp Included

□ : p.53

Unit:mm

Series	Designation	EDP 2700..		H (= HF)	B	WF	LF	Insert
		R	L					
MWLNR/L	MWLNR/L 1616H 06	0645	0646	16	16	20	100	WN0604
	MWLNR/L 2020K 06	0021	0022	20	20	25	125	
	MWLNR/L 2525M 06	0023	0024	25	25	32	150	
MWLNR/L	MWLNR/L 2020K 08	0025	0026	20	20	25	125	WN0804
	MWLNR/L 2525M 08	0027	0028	25	25	32	150	
	MWLNR/L 3232P 08	0029	0030	32	32	40	170	

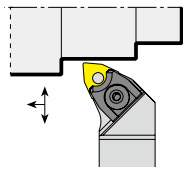

MWLNR/L

Approach angle
95°

Series	Designation	Information	Clamp	Clamp Screw	Upper Ring	Lower Ring	Pin	Shim	Allen Key
MW..	..06	Description	YAMK-01	YAKV-04-M5x17	-	-	YAPM-08	-	YAAL-03-3
		EDP	18000070	18000082			18000114		18000061
	..08	Description	YAMK-05	YAKV-03-M6x22	YABPL-01	YAS-01	YAPM-02	YAAWN-3-0001	YAAL-03-3
		EDP	18000073	18000081	18000058	18000052	18000111	18000151	18000061

Turning - Holder - External

Screw on type for CC Insert**

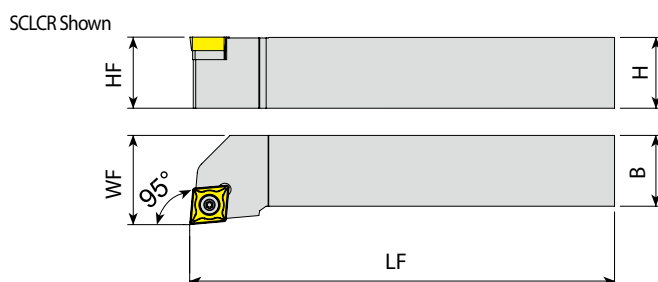

: p.57 Unit:mm

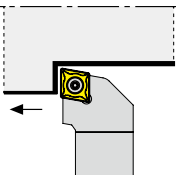
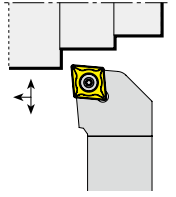
Series	Designation	EDP 2700.. R	EDP 2700.. L	H (= HF)	B	WF	LF	Insert
 <p>SCACR/L Approach angle 90°</p>	SCACR/L 0808E 06	0675	0676	08	08	10	70	CC0602
	SCACR/L 1010E 06	0677	0678	10	10	12	70	
	SCACR/L 1212F 09	0679	0680	12	12	16	80	CC09T3
	SCACR/L 1616H 09	0681	0682	16	16	20	100	
	SCACR/L 2020K 09	0683	0684	20	20	25	125	CC1204
	SCACR/L 2020K 12	0685	0686	20	20	25	125	
	SCACR/L 2525M 12	0687	0688	25	25	32	150	
 <p>SCLCR/L Approach angle 95°</p>	SCLCR/L 0808E 06	0689	0690	08	08	10	70	CC0602
	SCLCR/L 1010E 06	0691	-	10	10	12	70	
	SCLCR/L 1010E 09	0692	0693	10	10	12	70	CC09T3
	SCLCR/L 1212F 09	0089	0090	12	12	16	80	
	SCLCR/L 1616H 09	0091	0092	16	16	20	100	CC1204
	SCLCR/L 2020K 09	0093	0094	20	20	25	125	
	SCLCR/L 2525M 09	0694	0695	25	25	32	150	
	SCLCR/L 1616H 12	0696	-	16	16	20	100	CC1204
	SCLCR/L 2020K 12	0095	0096	20	20	25	125	
	SCLCR/L 2525M 12	0097	0098	25	25	32	150	

Series	Designation	Information	Screw	Shim	Shim Screw	Torx Key
SC..	..06	Descritpion	Y4008-M2.5x6	-	-	Y80-T08
		EDP	18000127	-	-	18000165
	..F09	Descritpion	Y4015-M3.5x11	YAACN-2-0001	YAAV-06-M3.5x11	Y80-T15
		EDP	18000118	18000135	18000159	18000167
	..H09	Descritpion	Y4015-M3.5x14	YAACN-2-0001	YAAV-06-M3.5x11	Y80-T15
		EDP	18000129	18000135	18000159	18000167
	..12	Descritpion	Y1020-M4.5x16	YAACN-2-0003	YAAV-07-M4.5x13	Y80-T20
		EDP	18000120	18000136	18000160	18000168
	..1010..09	Descritpion	Y4015-M3x9	-	-	Y80-T15
		EDP	18000132	-	-	18000159
	..1212..09	Descritpion	Y4015-M3.5x11	-	-	Y80-T15
		EDP	18000118	-	-	18000159
	..1616~2525..09	Descritpion	Y4015-M3.5x14	YAACN-2-0001	YAAV-06-M3.5x11	Y80-T15
		EDP	18000129	18000135	18000159	18000159
	..1616..12	Descritpion	Y1020-M5x11	-	-	Y80-T20
		EDP	18000121	-	-	18000168
	..2020~2525..12	Descritpion	Y1020-M4.5x16	YAACN-2-0003	YAAV-07-M4.5x13	Y80-T20
		EDP	18000120	18000136	18000160	18000168

Turning - Holder - External

Screw on type for DC Insert**

SDJCR Shown

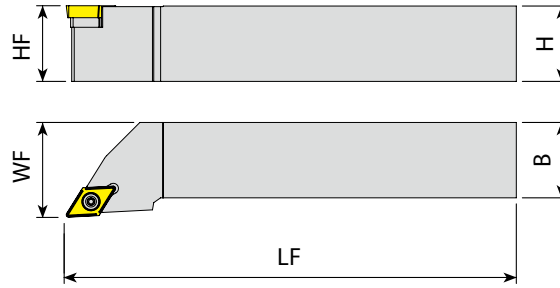

: p. 59

Unit: mm

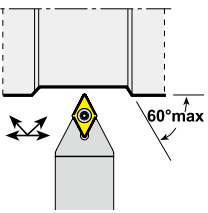
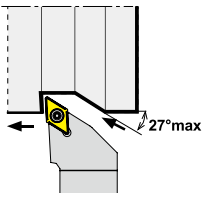
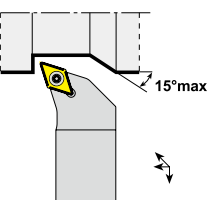
Series	Designation	EDP 2700.. R	L	H (= HF)	B	WF	LF	Insert	
 <p>SDNCN Approach angle 62.5°</p>	SDNCN 0808E 07	0723		08	08	4.0	70	DC0702	
	SDNCN 1010E 07	0724		10	10	5.0	70		
	SDNCN 1212F 07	0123		12	12	6.0	80		
	SDNCN 1616H 07	0725		16	16	8.0	100		
		SDNCN 1616H 11	0124		16	16	8.0	100	DC11T3
		SDNCN 2020K 11	0125		20	20	10.0	125	
		SDNCN 2525M 11	0126		25	25	12.5	150	
		SDNCN 3232P 11	0726		32	32	16.0	170	
SDJCR/L 0808E 07		0713	0714	08	08	10.0	70	DC0702	
SDJCR/L 1010E 07	0715	0716	10	10	12.0	70			
SDJCR/L 1212F 07	0113	0114	12	12	16.0	80			
 <p>SDJCR/L Approach angle 93°</p>	SDJCR/L 1616H 07	0717	0718	16	16	20.0	100	DC11T3	
	SDJCR/L 1616H 11	0117	0118	16	16	20.0	100		
	SDJCR/L 2020K 11	0119	0120	20	20	25.0	125		
	SDJCR/L 2525M 11	0719	0720	25	25	32.0	150		
	SDJCR/L 3232P 11	0721	0722	32	32	40.0	170		
 <p>SDHCR/L Approach angle 107.5°</p>	SDHCR/L 0808E 07	0697	0698	05	05	11.0	70	DC0702	
	SDHCR/L 1010E 07	0699	0700	10	10	12.0	70		
	SDHCR/L 1212F 07	0701	0702	12	12	16.0	80		
	SDHCR/L 1616H 07	0703	0704	16	16	20.0	100		
		SDHCR/L 1616H 11	0705	0706	16	16	20.0	100	DC11T3
		SDHCR/L 2020K 11	0707	0708	20	20	25.0	125	
		SDHCR/L 2525M 11	0709	0710	25	25	32.0	150	
		SDHCR/L 3232P 11	0711	0712	32	32	40.0	170	

Series	Designation	Information	Screw	Shim	Shim Screw	Torx Key
SD..	..07	Description	Y4008-M2.5x6	-	-	Y80-T08
		EDP	8000127	-	-	18000165
	..11	Description	Y4015-M3.5x14	YAADN-2-0001	YAAV-06-M3.5x11	Y80-T15
		EDP	18000129	18000140	18000159	18000167

Turning - Holder - External

Screw on type for RC Insert**

SRGCR Shown

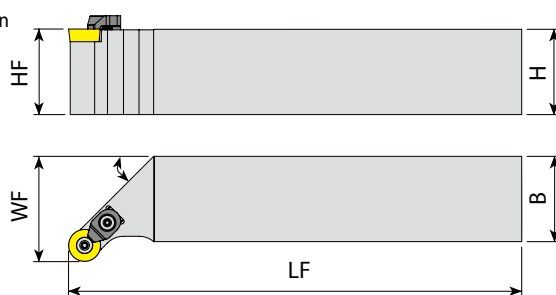

* 'C' Letter at Last : Optional Clamp Included

: p.61 Unit:mm

Series	Designation	EDP 2700..		H (= HF)	B	WF	LF	Insert
		R	L					
SRGCR/L	SRGCR/L 1616H 06	0739	0740	16	16	20.0	100	RC0602
	SRGCR/L 2020K 06	0741	0742	20	20	25.0	125	RC0602
	SRGCR/L 1616H 08C	0743	0744	16	16	32.0	100	RC0803
	SRGCR/L 2020K 08C	0745	0746	20	20	25.0	125	RC0803
	SRGCR/L 2525M 08C	0747	0748	25	25	32.0	150	RC0803
	SRGCR/L 1616H 10C	0749	0750	16	16	20.0	100	RC10T3
	SRGCR/L 2020K 10C	0751	0752	20	20	25.0	125	RC10T3
	SRGCR/L 2525M 10C	0753	0754	25	25	32.0	150	RC10T3
	SRGCR/L 3232P 10C	0755	0756	32	32	40.0	170	RC10T3
	SRGCR/L 2020K 12C	0757	0758	20	20	25.0	125	RC1204
	SRGCR/L 2525M 12C	0759	0760	25	25	32.0	150	RC1204
	SRGCR/L 3232P 12C	0761	0762	32	32	40.0	170	RC1204
SRDCN	SRDCN 1616H 06	0162	-	16	16	8.0	100	RC0602
	SRDCN 2020K 06	0163	-	20	20	10.0	125	RC0602
	SRDCN 2525M 06	0164	-	25	25	12.5	150	RC0602
	SRDCN 1616H 08C	0727	-	16	16	8.0	100	RC0803
	SRDCN 2020K 08C	0728	-	20	20	10.0	125	RC0803
	SRDCN 2525M 08C	0729	-	25	25	12.5	150	RC0803
	SRDCN 1616H 10C	0730	-	16	16	8.0	100	RC10T3
	SRDCN 2020K 10C	0731	-	20	20	10.0	125	RC10T3
	SRDCN 2525M 10C	0732	-	25	25	12.5	150	RC10T3
	SRDCN 3232P 10C	0733	-	32	32	16.0	170	RC10T3
	SRDCN 2020K 12C	0734	-	20	20	10.0	125	RC1204
	SRDCN 2525M 12C	0735	-	25	25	12.5	150	RC1204
SRDCN 3232P 12C	0736	-	32	32	16.0	170	RC1204	
SRDCR/L	SRDCR/L3232P12C	0737	0738	32	32	40.0	170	RC1204
SRHCR/L	SRHCR/L 2525K 06	0763	-	25	25	25.0	125	RC0602
	SRHCR/L 2525K 08	0764	0765	25	25	25.0	125	RC0803
	SRHCR/L 2525K 10	0766	0767	25	25	25.0	125	RC10T3
	SRHCR/L 2525K 12	0768	0769	25	25	25.0	125	RC1204

Series	Designation	Infomation	Clamp	Clamp Screw	Screw	Torx Key
SR..	..06	Descritpion	-	-	Y3008-M2.5x6	Y80-T08
		EDP	-	-	18000124	18000165
	..08	Descritpion	-	-	Y3008-M3x8	Y80-T15
		EDP	-	-	18000125	18000167
	..08C	Descritpion	YACK-15	Y4015-M3.5x11	Y3008-M3x8	Y80-T08
		EDP	18000069	18000118	18000125	18000165
	..10C	Descritpion	YACK-15	Y4015-M3.5x11	Y4015-M3.5x11	Y80-T15
		EDP	18000069	18000118	18000118	18000167
	..12C	Descritpion	YACK-05	Y4015-M4x11	Y4015-M3.5x11	Y80-T15
		EDP	18000065	18000119	18000118	18000167
	..10 ..12	Descritpion	-	-	Y4015-M3.5x11	Y80-T15
		EDP	-	-	18000118	18000167
..1616 ..08C	Descritpion	YACK-15	Y4015-M3.5x11	Y3008-M3x8	Y80-T08	
	EDP	18000069	18000118	18000125	18000165	

Turning - Holder - External

Screw on type for SC Insert**

SSSCR Shown

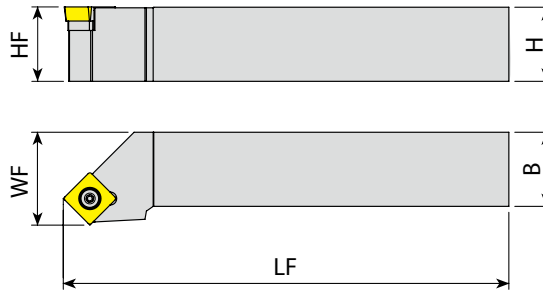

: p. 57

Unit: mm

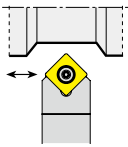
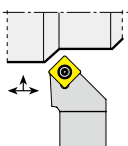
Series	Designation	EDP 2700.. R L	H (= HF)	B	WF	LF	Insert	
 <p>SSDCN Approach angle 45°</p>	SSDCN 1212F 09	0148	12	12	6.0	80	SC09T3	
	SSDCN 1616H 09	0149	16	16	8.0	100		
	SSDCN 2020K 09	0770	20	20	10.0	125		
		SSDCN 1616H 12	0771	16	16	8.0	100	SC1204
		SSDCN 2020K 12	0150	20	20	10.0	125	
		SSDCN 2525M 12	0151	25	25	12.5	150	
 <p>SSSCR/L Approach angle 45°</p>	SSSCR/L 1212F 09	0772 0773	12	12	16.0	80	SC09T3	
	SSSCR/L 1616H 09	0774 0775	16	16	20.0	100		
	SSSCR/L 2020K 09	0776 0777	20	20	25.0	125		
		SSSCR/L 1616H 12	0778 0779	16	16	20.0	100	SC1204
		SSSCR/L 2020K 12	0780 0781	20	20	25.0	125	
		SSSCR/L 2525M 12	0782 0783	25	25	32.0	150	

Series	Designation	Information	Screw	Shim	Shim Screw	Torx Key
SS..	..1212..09	Description	Y4015-M3.5x11	-	-	Y80-T15
		EDP	18000118	-	-	18000167
	..1616~2020..09	Description	Y4015-M3.5x14	YAASN-2-0001	YAAV-06-M3.5x11	Y80-T15
		EDP	18000129	18000135	18000159	18000167
	..1616..12	Description	Y4020-M4.5x12	YAASN-2-0004	YAAV-10-M4.5x8	Y80-T20
		EDP	18000134	18000144	18000162	18000168
	..2020~2525..12	Description	Y1020-M4.5x16	YAASN-2-0004	YAAV-07-M4.5x13	Y80-T20
		EDP	18000120	18000144	18000160	18000168

Screw on type for TC** Insert

STJCR Shown

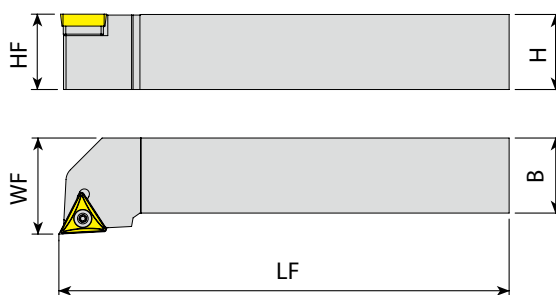

: p.64 Unit:mm

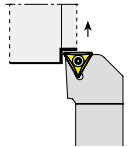
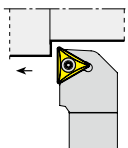
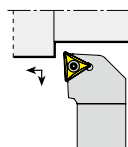
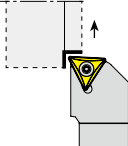
Series	Designation	EDP 2700.. R	L	H (= HF)	B	WF	LF	Insert
 STFCR/L Approach angle 91°	STFCR/L 1212F 11	0099	0100	12	12	16	80	TC1102
	STFCR/L 1616H 11	0101	0102	16	16	20	100	
	STFCR/L 1616H 16	0105	0106	16	16	20	100	TC16T3
	STFCR/L 2020K 16	0107	0108	20	20	25	125	
	STFCR/L 2525M 16	0109	0110	25	25	32	150	
	STFCR/L 3232P 16	0784	0785	32	32	40	170	
 STGCR/L Approach angle 91°	STGCR/L 1212F 11	0786	0787	12	12	16	80	TC1102
	STGCR/L 1616H 11	0433	0788	16	16	20	100	TC16T3
	STGCR/L 1616H 16	0789	0790	16	16	20	100	
	STGCR/L 2020K 16	0434	0791	20	20	25	125	
	STGCR/L 2525M 16	0792	0793	25	25	32	150	
	STGCR/L 3232P 16	0794	0795	32	32	40	170	
 STJCR/L Approach angle 93°	STJCR/L 1212F 11	0796	0797	12	12	16	80	TC1102
	STJCR/L 1616H 11	0798	0799	16	16	20	100	TC16T3
	STJCR/L 1616H 16	0800	0801	16	16	20	100	
	STJCR/L 2020K 16	0802	0803	20	20	25	125	
	STJCR/L 2525M 16	0804	0805	25	25	32	150	
	STJCR/L 3232P 16	0806	0807	32	32	40	170	
 STUCR/L Approach angle 93°	STUCR/L 1212F 11	0808	0809	12	12	16	80	TC1102
	STUCR/L 1616H 11	0810	0811	16	16	20	100	TC16T3
	STUCR/L 2020K 16	0812	0813	20	20	25	125	
	STUCR/L 2525M 16	0814	0815	25	25	32	150	
	STUCR/L 3232P 16	0816	0817	32	32	40	170	

Series	Designation	Infomation	Screw	Shim	Shim Screw	Torx Key
ST..	..11	Descritpion	Y4008-M2.5x6	-	-	Y80-T08
		EDP	18000127	-	-	18000165
	..16	Descritpion	Y4015-M3.5x14	YAATN-2-0001	YAAV-06-M3.5x11	Y80-T15
		EDP	18000129	18000146	18000159	18000167

Turning - Holder - External

Screw on type for VB Insert**

SVJBR Shown

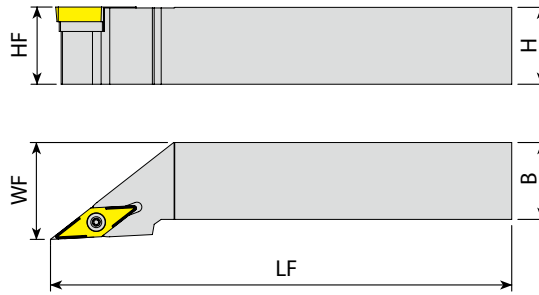

: p.66

Unit:mm

Series	Designation	EDP 2700.. R	L	H (= HF)	B	WF	LF	Insert
 SVHBR/L Approach angle 107.5°	SVHBR/L 2020K 16	0818	0819	20	20	25.0	125	VB1604
	SVHBR/L 2525M 16	0820	0821	25	25	32.0	150	
	SVHBR/L 3232P 16	0822	0823	32	32	40.0	170	
 SVVBN Approach angle 72.5°	SVVBN 2020K 16	0131		20	20	10.0	125	VB1604
	SVVBN 2525M 16	0132		25	25	12.5	150	
	SVVBN 3232P 16	0827		32	32	16.0	170	
 SVJBR/L Approach angle 93°	SVJBR/L 1616H 16	0824	0825	16	16	20.0	100	VB1604
	SVJBR/L 2020K 16	0127	0128	20	20	25.0	125	
	SVJBR/L 2525M 16	0129	0130	25	25	32.0	150	
	SVJBR/L 3232P 16	0436	0826	32	32	40.0	170	

Series	Designation	Information	Screw	Shim	Shim Screw	Torx Key
SV..	..16	Description	Y4015-M3.5x14	YAAVN-2-0002	YAAV-06-M3.5x11	Y80-T15
		EDP	18000129	28000043	18000159	18000167

Screw on type for VC** Insert

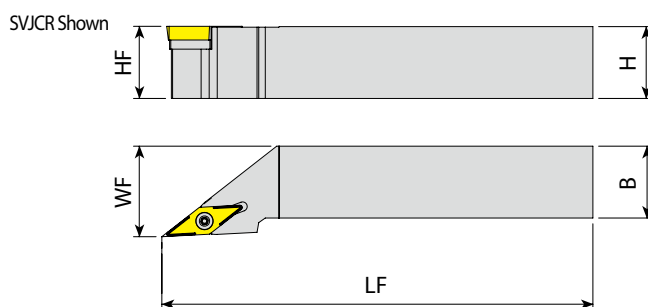

: p.67 Unit:mm

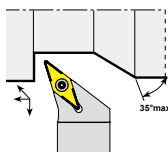
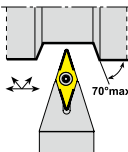
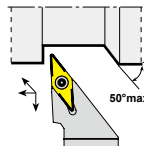
Series	Designation	EDP 2700.. R	EDP 2700.. L	H (= HF)	B	WF	LF	Insert	
 <p>SVHCR/L Approach angle 107.5°</p>	SVHCR/L 2020K 16	0828	0829	20	20	25	125	VC1604	
	SVHCR/L 2525M 16	0830	0831	25	25	32	150		
	SVHCR/L 3232P 16	0832	0833	32	32	40	170		
 <p>SVVCN Approach angle 72.5°</p>	SVVCN 1212-F11	0143		12	12	06	80	VC1103	
	SVVCN 1616-H11	0144		16	16	08	100		
	SVVCN 2020-K11	0145		20	20	10	125		
	SVVCN 2020-K16	0146		20	20	10	125		
		SVVCN 2525M 16	0147		25	25	12.5	150	VC1604
		SVVCN 3232P 16	0838		32	32	16	170	
 <p>SVJCR/L Approach angle 93°</p>	SVJCR/L 1212F 16	0834	0835	12	12	16	80	VC1604	
	SVJCR/L 2020K 16	0139	0140	20	20	25	125		
	SVJCR/L 2525M 16	0141	0142	25	25	32	150		
	SVJCR/L 3232P 16	0836	0837	32	32	40	170		
		SVJCR/L 1212-F11	0133	0134	12	12	16	80	VC1103
		SVJCR/L 1616-H11	0135	0136	16	16	20	100	
		SVJCR/L 2020-K11	0137	0138	20	20	25	125	

Series	Designation	Information	Screw	Shim	Shim Screw	Torx Key
SV..	..11	Descritpion	Y4008-M2.5x6	-	-	Y80-T08
		EDP	18000127	-	-	18000165
	..16	Descritpion	Y4015-M3.5x14	YAAVN-2-0002	YAAV-06-M3.5x11	Y80-T15
		EDP	18000129	28000043	18000159	18000167
	..1212..16	Descritpion	Y4015-M3.5x11	-	-	Y80-T15
		EDP	18000118	-	-	18000167
	..2020~3232..16	Descritpion	Y4015-M3.5x14	YAAVN-2-0002	YAAV-06-M3.5x11	Y80-T15
		EDP	18000129	28000043	18000159	18000167

Turning - Holder - Internal

Lever Lock type for CN Insert**

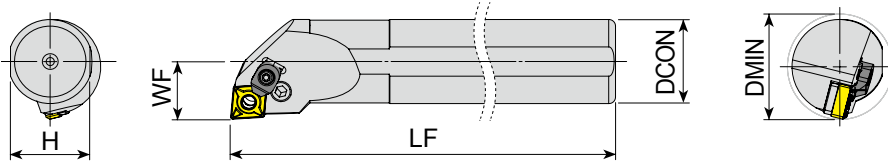

* 'C' Letter at Last : Optional Clamp Included

: p. 30

Unit:mm

Series	Designation	EDP 2700.. R L	DMIN	DCON	H	WF	LF	Insert		
●	A25R - PCLNR/L 12C	0839 0840	32	25	23	17	200	CN1204		
	A32S - PCLNR/L 12C	0841 0842	40	32	30	22	250			
	A40T - PCLNR/L 12C	0843 0844	50	40	37.5	27	300			
	A50U - PCLNR/L 12C	0845 0846	63	50	47	35	350			
	S25S - PCLNR/L 12C	0863 0864	32	25	23	17	250			
	S32T - PCLNR/L 12C	0865 0866	40	32	30	22	300			
	S40U - PCLNR/L 12C	0867 0868	50	40	37.5	27	350			
	S50V - PCLNR/L 12C	0869 0870	63	50	47	35	400			
	●	A32S - PCLNR/L 16C	0847 0848	40	32	30	22		250	CN1606
		A40T - PCLNR/L 16C	0849 0850	50	40	37.5	27		300	
A50U - PCLNR/L 16C		0851 0852	63	50	47	35	350			
S32T - PCLNR/L 16C		0871 0872	40	32	30	22	300			
S40U - PCLNR/L 16C		0873 0874	50	40	37.5	27	350			
S50V - PCLNR/L 16C		0875 0876	63	50	47	35	400			
●		A40T - PCLNR/L 19C	0853 0854	50	40	37.5	27	300	CN1906	
		A50U - PCLNR/L 19C	0855 0856	63	50	47	35	350		
		S40U - PCLNR/L 19C	0877 0878	50	40	37.5	27	350		
		S50V - PCLNR/L 19C	0879 0880	63	50	47	35	400		

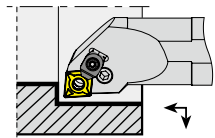

..-PCLNR/L

Approach angle
95°

Series	Designation	Infomation	Lever	Lever Screw	Clamp	Clamp Screw	Shim	Shim Pin	Allen Key
..25..- 12C	Description	YAPL-02	YALV-08-M8x16	YACK-05	Y4015-M4x11	YAACN-3-0001	YAAY-02	YAAL-03-3	
	EDP	18000093	18000104	18000065	18000119	18000137	18000054	18000061	
..32~50..- 12C	Description	YAPL-02	YALV-03-M8x19	YACK-05	Y4015-M4x11	YAACN-3-0001	YAAY-02	YAAL-03-3	
	EDP	18000093	18000100	18000065	18000119	18000137	18000054	18000061	
..PC..	Description	YAPL-04	YALV-04-M8x22	YACK-09	YAAV-05-M6x15	YAACN-3-0002	YAAY-03	YAAL-03-3	
	EDP	18000095	18000101	18000066	18000078	18000138	18000055	18000061	
..19C	Description	YAPL-05	YALV-05-M10x27	YACK-09	YAAV-05-M6x15	YAACN-3-0003	YAAY-04	YAAL-05-4	
	EDP	18000096	18000102	18000066	18000078	18000139	18000056	18000062	
..19C	Description	YAPL-05	YALV-05-M10x27	YACK-09	YAAV-05-M6x15	YAACN-3-0003	YAAY-04	YAAL-05-4	
	EDP	18000096	18000102	18000066	18000078	18000139	18000056	18000062	

Turning - Holder - Internal

Lever Lock type for DN** Insert

..PDQNR Shown

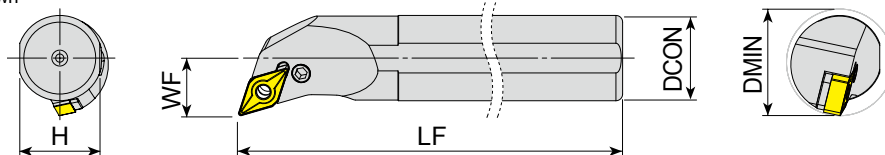

: p. 35

Unit:mm

Series	Designation	EDP 2700..		DMIN	DCON	H	WF	LF	Insert
		R	L						
●	A32S - PDQNR/L 1504	0895	-	40	32	30	22	250	DN1504
	A40T - PDQNR/L 1504	0896	-	50	40	37.5	27	300	
	S32T - PDQNR/L 1504	0903	-	40	32	30	22	300	
	X S40U - PDQNR/L 1504	0904	-	50	40	37.5	27	350	
	S50V - PDQNR/L 1504	0905	-	63	50	47	35	400	
●	A32S - PDQNR/L 15	0897	0898	40	32	30	22	250	DN1506
	A40T - PDQNR/L 15	0899	0900	50	40	37.5	27	300	
	A50U - PDQNR/L 15	0901	0902	63	50	47	35	350	
	S32T - PDQNR/L 15	0906	0907	40	32	30	22	300	
	X S40U - PDQNR/L 15	0908	0909	50	40	37.5	27	350	
	S50V - PDQNR/L 15	0910	0911	63	50	47	35	400	
●	A32S - PDUNR/L 15	0920	0921	40	32	30	22	250	DN1506
	A40T - PDUNR/L 15	0922	0923	50	40	37.5	27	300	
	A50U - PDUNR/L 15	0924	0925	63	50	47	35	350	
	S25S - PDUNR/L 15	0934	0935	32	25	23	19	250	
	X S32T - PDUNR/L 15	0936	0937	40	32	30	22	300	
	S40U - PDUNR/L 15	0938	0939	50	40	37.5	27	350	
	S50V - PDUNR/L 15	0940	0941	63	50	47	35	400	

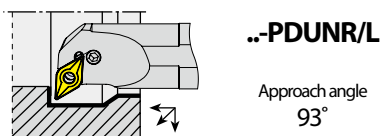
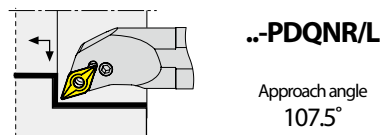

Series	Designation	Information	Lever	Lever Screw	Shim	Shim Pin	Allen Key
..15	Description		YAPL-03	YALV-03-M8x19	YAADN-3-0001	YAAY-02	YAAL-03-3
	EDP		18000094	18000100	18000142	18000054	18000061
..1504	Description		YAPL-03	YALV-03-M8x19	YAADN-2-0003	YAAY-02	YAAL-03-3
	EDP		18000094	18000100	18000141	18000054	18000061
..25..15	Description		YAPL-03	YALV-08-M8x16	YAADN-3-0001	YAAY-02	YAAL-03-3
	EDP		18000094	18000104	18000142	18000054	18000061
..32~50..15	Description		YAPL-03	YALV-03-M8x19	YAADN-3-0001	YAAY-02	YAAL-03-3
	EDP		18000094	18000100	18000142	18000054	18000061

Turning - Holder - Internal Lever Lock type for SN** Insert

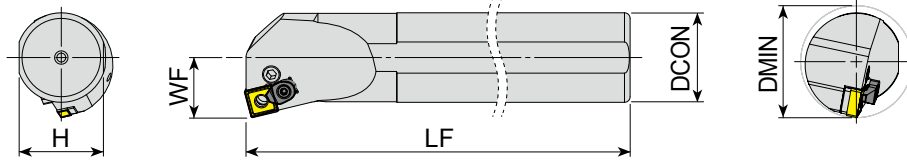

* 'C' Letter at Last : Optional Clamp Included

: p. 42

Unit:mm

Series	Designation	EDP 2700.. R L	DMIN	DCON	H	WF	LF	Insert
 ..-PSKNR/L Approach angle 75°	X S25S - PSKNR/L 12C	0958 0959	32	25	23	17	250	SN1204
	S32T - PSKNR/L 12C	0960 0961	40	32	30	22	300	
	X S40U - PSKNR/L12C	0962 0963	50	40	37.5	27	350	SN1204
	S50V - PSKNR/L12C	0964 0965	63	50	47	35	400	

Series	Designation	Infomation	Lever	Lever Screw	Clamp	Clamp Screw	Shim	Shim Pin	Allen Key
..PS..	..25.. 12C	Descritpion	YAPL-02	YALV-08-M8x16	YACK-05	Y4015-M4x11	YAASN-3-0004	YAAY-02	YAAL-03-3
		EDP	18000093	18000104	18000065	18000119	18000145	18000054	18000061
	..32.. 12C ..40.. 12C ..50.. 12C	Descritpion	YAPL-02	YALV-03-M8x19	YACK-05	Y4015-M4x11	YAASN-3-0004	YAAY-02	YAAL-03-3
		EDP	18000093	18000100	18000065	18000119	18000145	18000054	18000061

Lever Lock type for TN** Insert

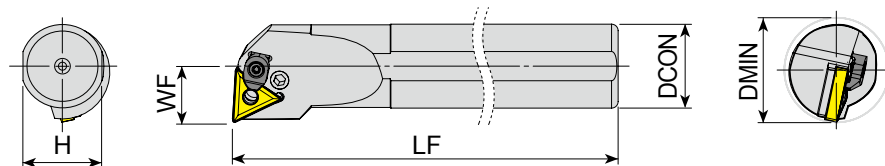

* 'C' Letter at Last : Optional Clamp Included

☐ : p.47

Unit:mm

Series	Designation	EDP 2700..		DMIN	DCON	H	WF	LF	Insert
		R	L						
	S16P - PTUNR/L 16	1014	1015	20	16	14.8	11	170	TN1604
	S20R - PTUNR/L 16	1016	1017	25	20	18.3	13	200	
X	S25S - PTUNR/L 16C	1018	1019	32	25	23	17	250	
	S32T - PTUNR/L 16C	1020	1021	40	32	30	22	300	
	S40U - PTUNR/L 16C	1022	1023	50	40	37.5	27	350	
	S32T - PTUNR/L 22C	1024	1025	40	32	30	22	300	TN2204
X	S40U - PTUNR/L 22C	1026	1027	50	40	37.5	27	350	
	S50V - PTUNR/L 22C	1028	1029	63	50	47	35	400	

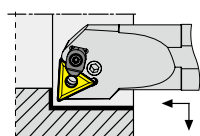

..PTUNR/L

Approach angle
93°

Series	Designation	Information	Lever	Lever Screw	Clamp	Clamp Screw	Shim	Shim Pin	Allen Key
..PT..	..16..16	Description	YAPL-08	YALV-07-M6x13	-	-	-	YAAY-07	YAAL-02-2.5
		EDP	18000097	18000103	-	-	-	18000057	18000060
	..20..16	Description	YAPL-01	YALV-01-M6x14	-	-	YAATN-3-0025	YAAY-01	YAAL-02-2.5
		EDP	18000092	18000098	-	-	18000149	18000053	18000060
	..16C	Description	YAPL-01	YALV-02-M6x17	YACK-05	Y4015-M4x11	YAATN-3-0025	YAAY-01	YAAL-02-2.5
		EDP	18000092	18000099	18000065	18000119	18000149	18000053	18000060
..22C	Description	YAPL-02	YALV-03-M8x19	YACK-05	Y4015-M4x11	YAATN-3-0015	YAAY-02	YAAL-03-3	
	EDP	18000093	18000100	18000065	18000119	18000148	18000054	18000061	

Turning - Holder - Internal

Lever Lock type for WN** Insert

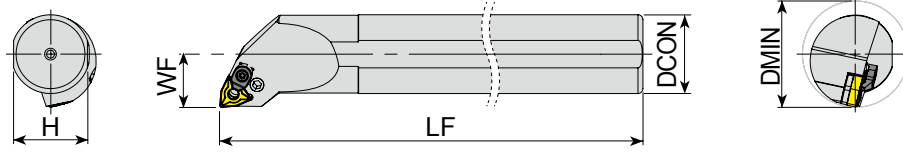

: p. 53

Unit:mm

Series	Designation	EDP 2700.. R	L	DMIN	DCON	H	WF	LF	Insert
●	A20P - PWNLR/L 06	1048	1049	25	20	18.3	13	170	WN0604
	A25R - PWNLR/L 06	1050	1051	32	25	23	17	200	
	A32S - PWNLR/L 06	1052	1053	40	32	30	22	250	
	S20R - PWNLR/L 06	1076	1077	25	20	18.3	13	200	
	X S25S - PWNLR/L 06	1078	1079	32	25	23	17	250	
	S32T - PWNLR/L 06	1080	1081	40	32	30	22	300	
●	A25R - PWNLR/L 08C	1054	1055	32	25	23	17	200	WN0804
	A32S - PWNLR/L 08C	1056	1057	40	32	30	22	250	
	A40T - PWNLR/L 08C	1058	1059	50	40	37.5	27	300	
	A50U - PWNLR/L 08C	1060	1061	63	50	47	35	350	
	S25S - PWNLR/L 08C	1082	1083	32	25	23	17	250	
	X S32T - PWNLR/L 08C	1084	1085	40	32	30	22	300	
	S40U - PWNLR/L 08C	1086	1087	50	40	37.5	27	350	
	S50V - PWNLR/L 08C	1088	1089	63	50	47	35	400	

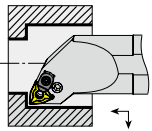

..-PWNLR/L

Approach angle
95°

Series	Designation	Infomation	Lever	Lever Screw	Clamp	Clamp Screw	Shim	Shim Pin	Allen Key
..PW..	..20..06	Descritpion	YAPL-01	YALV-01-M6x14	-	-	YAAWN-SW317	YAAY-01	YAAL-02-2.5
		EDP	18000092	18000098			18000152	18000053	18000060
	..25~32..06	Descritpion	YAPL-01	YALV-02-M6x17	-	-	YAAWN-SW317	YAAY-01	YAAL-02-2.5
		EDP	18000092	18000099			18000152	18000053	18000060
..08C	..08C	Descritpion	YAPL-02	YALV-03-M8x19	YACK-05	Y4015-M4x11	YAAWN-3-0001	YAAY-02	YAAL-03-3
		EDP	18000093	18000100	18000065	18000119	18000151	18000054	18000061

Double Clamp type for CN** Insert

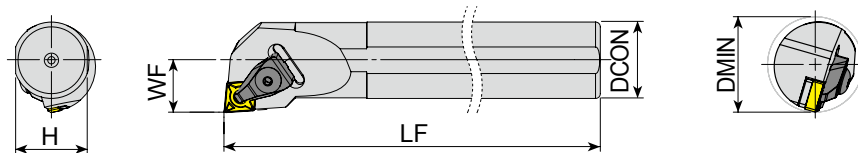

: p.30

Unit:mm

TURNING

PARTING & GROOVING

MILLING

DRILLING

TECHNICAL INFORMATION

Series	Designation	EDP 2700..		DMIN	DCON	H	WF	LF	Insert
		R	L						
<p>..-TCLNR/L Approach angle 95°</p>	X S25S -TCLNR/L 12	0881	0882	32	25	23	17	250	CN1204
	S32T -TCLNR/L 12	0883	0884	40	32	30	22	300	
	S40U -TCLNR/L 12	0885	0886	50	40	37.5	27	350	
	S50V -TCLNR/L 12	0887	0888	63	50	47	35	400	
	S32T -TCLNR/L 16	0889	0890	40	32	30	22	300	CN1606
	X S40U -TCLNR/L 16	0891	0892	50	40	37.5	27	350	
	S50V -TCLNR/L 16	0893	0894	63	50	47	35	400	

Series	Designation	Information	Clamp	Clamp Screw	Upper Ring	Lower Ring	Shim	Shim Screw	Allen Key
..TC..	..25..12	Description	YATK-02	YAKV-30-M6x22	YABPL-01	YAS-01	YAACN-3-0001	YAAV-13-M5x8	YAAL-03-3
		EDP	18000075	18000091	18000058	18000052	18000137	18000163	18000061
	..32~50..12	Description	YATK-02	YAKV-30-M6x22	YABPL-01	YAS-01	YAACN-3-0001	YAAV-02-M5x12	YAAL-03-3
		EDP	18000075	18000091	18000058	18000052	18000137	18000156	18000061
	..16	Description	YATK-04	YAKV-19-M7x25	YABPL-02	-	YAACN-3-0002	YAAV-05-M6x15	YAAL-05-4
		EDP	18000077	18000088	18000059		18000138	18000078	18000062

Turning - Holder - Internal

Double Clamp type for DN** Insert

..TDQNR Shown

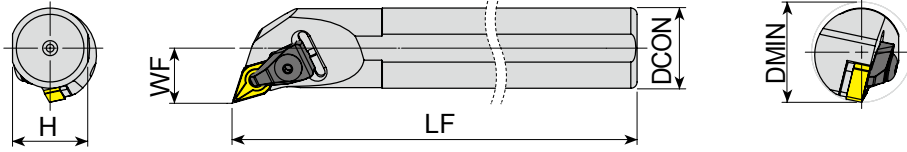

: p. 35 Unit: mm

Series	Designation	EDP 2700.. R L	DMIN	DCON	H	WF	LF	Insert
<p>..TDQNR/L Approach angle 107.5°</p>	S25S - TDQNR/L 15	0912 0913	32	25	23	17	250	DN1506
	S32T - TDQNR/L 15	0914 0915	40	32	30	22	300	
	S40U - TDQNR/L 15	0916 0917	50	40	37.5	27	350	
	S50V - TDQNR/L 15	0918 0919	63	50	47	35	400	
<p>..TDUNR/L Approach angle 93°</p>	S25S - TDUNR/L 15	0942 0943	34	25	23	17	250	DN1506
	S32T - TDUNR/L 15	0944 0945	40	32	30	22	300	
	S40U - TDUNR/L 15	0946 0947	50	40	37.5	27	350	
	S50V - TDUNR/L 15	0948 0949	63	50	47	35	400	

Series	Designation	Infomation	Clamp	Clamp Screw	Upper Ring	Lower Ring	Shim	Shim Screw	Allen Key
..TDQ..25..15	Descritpion	YATK-02	YAKV-30-M6x22	YABPL-01	-	YAADN-3-0001	YAAV-13-M5x8	YAAL-03-3	
	EDP	18000075	18000091	18000058		18000142	18000163	18000061	
..TD.. ..25..15	Descritpion	YATK-02	YAKV-30-M6x22	YABPL-01	YAS-01	YAADN-3-0001	YAAV-13-M5x8	YAAL-03-3	
	EDP	18000075	18000091	18000058	18000052	18000142	18000163	18000061	
..32~50..15	Descritpion	YATK-02	YAKV-30-M6x22	YABPL-01	YAS-01	YAADN-3-0001	YAAV-02-M5x12	YAAL-03-3	
	EDP	18000075	18000091	18000058	18000052	18000142	18000156	18000061	

Turning - Holder - Internal

Double Clamp type for SN** Insert

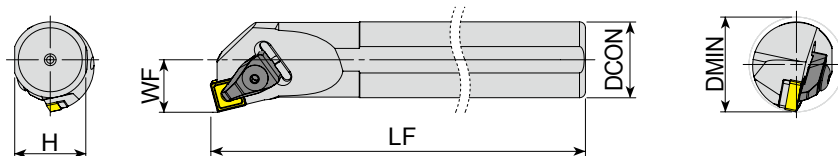

: p.42

Unit:mm

Series	Designation	EDP 2700..		DMIN	DCON	H	WF	LF	Insert
		R	L						
 ..TSKNR/L Approach angle 75°	S25S - TSKNR/L 12	0966	-	32	25	23	17	250	SN1204
	S32T - TSKNR/L12	0968	0969	40	32	30	22	300	
	S40U - TSKNR/L 12	0970	0971	50	40	37.5	27	350	

TURNING

PARTING & GROOVING

MILLING

DRILLING

TECHNICAL INFORMATION

Series	Designation	Information	Clamp	Clamp Screw	Upper Ring	Lower Ring	Shim	Shim Screw	Allen Key
..TS..	..12	Description	YATK-02	YAKV-30-M6x22	YABPL-01	YAS-01	YAASN-3-0004	YAAV-13-M5x8	YAAL-03-3
		EDP	18000075	18000091	18000058	18000052	18000145	18000163	18000061

Turning - Holder - Internal

Double Clamp type for TN** Insert

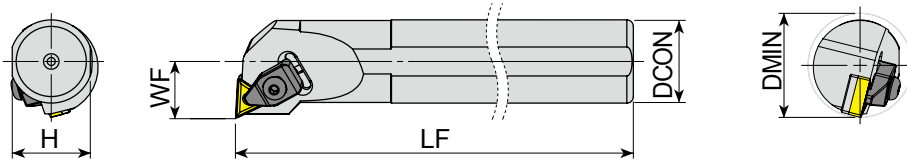

: p. 47 Unit: mm

Series	Designation	EDP 2700..		DMIN	DCON	H	WF	LF	Insert
		R	L						
X	S25S - TTUNR/L 16	1030	1031	32	25	23	17	250	TN1604
	S32T - TTUNR/L 16	1032	1033	40	32	30	22	300	
X	S25S - TTUNR/L 22	1034	1035	32	25	23	17	250	TN2204
	S32T - TTUNR/L 22	1036	1037	40	32	30	22	300	
	S40U - TTUNR/L 22	1038	1039	50	40	37.5	27	350	
	S50V - TTUNR/L 22	1040	1041	63	50	47	35	400	

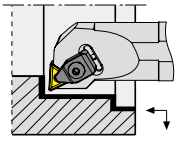

..- TTUNR/L

Approach angle
93°

Series	Designation	Infomation	Clamp	Clamp Screw	Upper Ring	Lower Ring	Shim	Shim Screw	Allen Key
..TT..	..16	Descritpion	YATK-01	YAKV-01-M5x22	YABPL-01	-	YAATN-2-0002	YAAV-03-M5x12	YAAL-03-3
		EDP	18000074	18000080	18000058		18000147	18000156	18000061
	..22	Descritpion	YATK-02	YAKV-30-M6x22	YABPL-01	YAS-01	YAATN-3-0015	YAAV-02-M5x12	YAAL-03-3
		EDP	18000075	18000091	18000058	18000052	18000148	18000156	18000061

Double Clamp type for VN** Insert

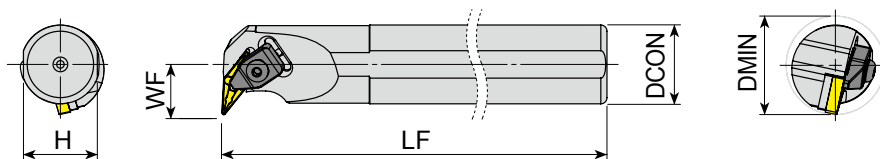

: p. 51

Unit:mm

TURNING

PARTING & GROOVING

MILLING

DRILLING

TECHNICAL INFORMATION

Series	Designation	EDP 2700..		DMIN	DCON	H	WF	LF	Insert	
		R	L							
<p>..TVUNR/L Approach angle 93°</p>	X	S25S - TVUNR/L 16	1042	1043	36	25	23	20	250	VN1604
		S32T - TVUNR/L 16	1044	1045	40	32	30	22	300	
		S40U - TVUNR/L 16	1046	1047	50	40	37.5	27	350	

Series	Designation	Information	Clamp	Clamp Screw	Upper Ring	Shim	Shim Screw	Allen Key
..TV..	..16	Description	YATK-01	YAKV-01-M5x22	YABPL-01	YAAVN-2-0002	YAAV-04-M5x12	YAAL-03-3
		EDP	18000074	18000080	18000058	18000150	18000185	18000061

Turning - Holder - Internal

Double Clamp type for WN** Insert

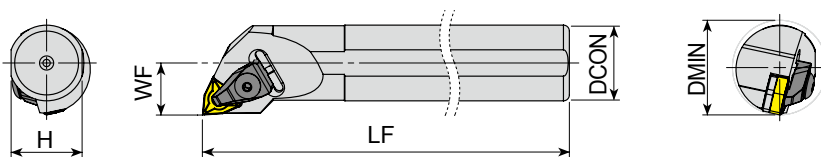

: p.53 Unit:mm

Series	Designation	EDP 2700..		DMIN	DCON	H	WF	LF	Insert
		R	L						
X	S25S - TWLNR/L 06	1090	1091	32	25	23	17	250	WN0604
	S32T - TWLNR/L 06	1092	1093	40	32	30	22	300	
●	A40T - TWLNR/L 08	1062	-	50	40	37.5	27	300	WN0804
	A50U - TWLNR/L 08	1063	-	63	50	47	35	350	
X	S25S - TWLNR/L 08	1094	1095	32	25	23	17	250	
	S32T - TWLNR/L 08	1096	1097	40	32	30	22	300	
	S40U - TWLNR/L 08	1098	1099	50	40	37.5	27	350	
	S50V - TWLNR/L 08	1100	1101	63	50	47	35	400	

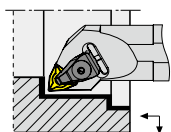

..-TWLNR/L

Approach angle
95°

Series	Designation	Infomation	Clamp	Clamp Screw	Upper Ring	Lower Ring	Shim	Shim Screw	Allen Key
..06		Descritpion	YATK-01	YAKV-01-M5x22	YABPL-01	-	YAAWN-SW317	YAAV-01-M3x10	YAAL-03-3
		EDP	18000074	18000080	18000058		18000152	18000155	18000061
..25..08		Descritpion	YATK-02	YAKV-30-M6x22	YABPL-01	YAS-01	YAAWN-3-0001	YAAV-13-M5x8	YAAL-03-3
		EDP	18000075	18000091	18000058	18000052	18000151	18000163	18000061
..32~50..08		Descritpion	YATK-02	YAKV-30-M6x22	YABPL-01	YAS-01	YAAWN-3-0001	YAAV-02-M5x12	YAAL-03-3
		EDP	18000075	18000091	18000058	18000052	18000151	18000156	18000061

Turning - Holder - Internal

Multi-Clamp type for CN Insert**

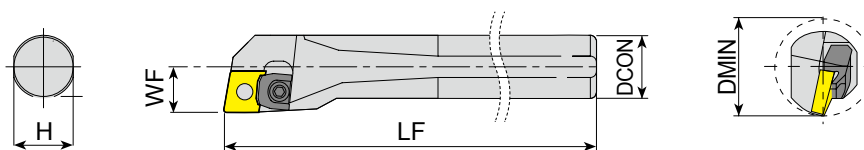

: p. 30

Unit:mm

Series	Designation	EDP 2700.. R	EDP 2700.. L	DMIN	DCON	H	WF	LF	Insert
 ..-MCLNR/L Approach angle 95°	S20R - MCLNR/L12	0857	0858	25	20	18.3	13	200	CN1204
	S32T - MCLNR/L12	0861	0862	40	32	30	22	300	
	X								

Series	Designation	Information	Clamp	Clamp Screw	Shim	Shim Pin	Allen Key
..MC..	..20..12	Description	YAMK-07	YAKV-04-M5x17	-	YAPM-12	YAAL-03-3
		EDP	28000019	18000082	-	28000025	18000061
	..32..12	Description	YAMK-03	-	YAACN-3-0001	YAPM-04	-
		EDP	28000020	-	18000137	18000113	-

Turning - Holder - Internal

Multi-Clamp type for DN Insert**

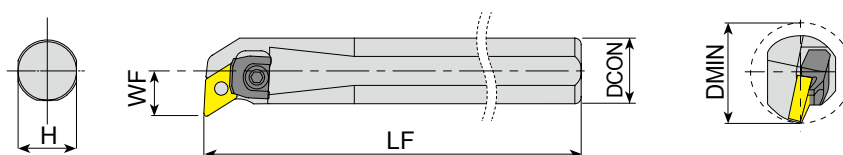

: p. 35

Unit:mm

Series	Designation	EDP 2700.. R	EDP 2700.. L	DMIN	DCON	H	WF	LF	Insert
 ..-MDUNR/L Approach angle 95°	S32T - MDUNR/L15	0928	0929	40	32	30	22	300	DN1506
	S40U - MDUNR/L15	0930	0931	50	40	37.5	27	350	
	S50V - MDUNR/L15	0932	0933	63	50	47	35	400	
	X								

Series	Designation	Information	Clamp	Clamp Screw	Upper Ring	Lower Ring	Shim	Shim Pin	Allen Key
..MD..	..15	Description	YAMK-04	YAKV-30-M6x22	YABPL-01	YAS-01	YAADN-3-0001	YAPM-04	YAAL-03-3
		EDP	18000072	18000091	18000058	18000052	18000142	18000113	18000061

Turning - Holder - Internal

Multi-Clamp type for TN** Insert

..MTFNR Shown

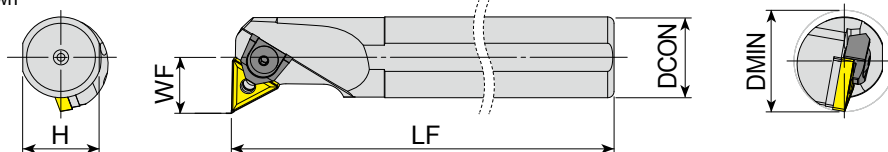

: p. 47 Unit: mm

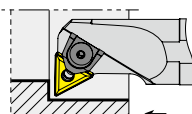
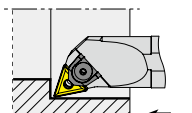
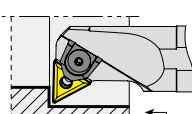
Series	Designation	EDP 2700.. R L	DMIN	DCON	H	WF	LF	Insert
 ..- MTFNR/L Approach angle 91°	X S20R - MTFNR/L 16	0972 -	25	20	18.3	14	200	TN1604
	S25S - MTFNR/L 16	0973 0974	32	25	23	17	250	
	S32T - MTFNR/L 16	0975 0976	40	32	30	22	300	
	S40U - MTFNR/L 16	0977 0978	50	40	37.5	27	350	TN2204
	X S32T - MTFNR/L 22	0979 0980	40	32	30	22	300	
S40U - MTFNR/L 22	0981 0982	50	40	37.5	27	350		
S50V - MTFNR/L 22	0983 -	63	50	47	35	400		
 ..- MTQNR/L Approach angle 107.5°	X S20R - MTQNR/L 16	0984 0985	25	20	18.3	13	200	TN1604
	S32T - MTQNR/L 16	0988 0989	40	32	30	22	300	
	S40U - MTQNR/L 16	0990 0991	50	40	37.5	27	350	
	S32T - MTQNR/L 22	0992 0993	40	32	30	22	300	TN2204
	S40U - MTQNR/L 22	0994 0995	50	40	37.5	27	350	
S50V - MTQNR/L 22	0996 0997	63	50	47	35	400		
 ..- MTUNR/L Approach angle 93°	X S20R - MTUNR/L 16	0998 0999	25	20	18.3	13	200	TN1604
	S25S - MTUNR/L 16	1000 1001	32	25	23	17	250	
	S32T - MTUNR/L 16	1002 1003	40	32	30	22	300	
	S40U - MTUNR/L 16	1004 1005	50	40	37.5	27	350	TN2204
	S50V - MTUNR/L 16	1006 1007	63	50	47	35	400	

Series	Designation	Infomation	Clamp	Clamp Screw	Upper Ring	Lower Ring	Pin	Shim	Shim Pin	Allen Key
..20..16	Descritpion	YAMK-02	YAMK-02	YAKV-17-M5x15	-	-	YAPM-03	-	-	YAAL-03-3
	EDP	18000071	18000071	18000087	-	-	18000112	-	-	18000061
..22	Descritpion	YAMK-04	YAMK-04	YAKV-30-M6x22	YABPL-01	YAS-01	YAPM-02	YAATN-3-0015	-	YAAL-03-3
	EDP	18000072	18000072	18000091	18000058	18000052	18000054	18000148	-	18000061
..25..16	Descritpion	YAMK-04	YAMK-04	YAKV-30-M6x22	YABPL-01	YAS-01	YAPM-14	YAATN-2-0002	-	YAAL-03-3
	EDP	18000072	18000072	18000091	18000058	18000052	18000117	18000147	-	18000061
..32~40..16	Descritpion	YAMK-04	YAMK-04	YAKV-30-M6x22	YABPL-01	YAS-01	-	YAATN-2-0002	YAPM-14	YAAL-03-3
	EDP	18000072	18000072	18000091	18000058	18000052	-	18000147	18000117	18000061
..32~50..16	Descritpion	YAMK-04	YAMK-04	YAKV-30-M6x22	YABPL-01	YAS-01	YAPM-01	YAATN-2-0002	-	YAAL-03-3
	EDP	18000072	18000072	18000091	18000058	18000052	18000110	18000147	-	18000061
..32~50..22	Descritpion	YAMK-04	YAMK-04	YAKV-30-M6x22	YABPL-01	YAS-01	-	YAATN-3-0015	YAPM-02	YAAL-03-3
	EDP	18000072	18000072	18000091	18000058	18000052	-	18000148	18000111	18000061

Multi-Clamp type for WN** Insert

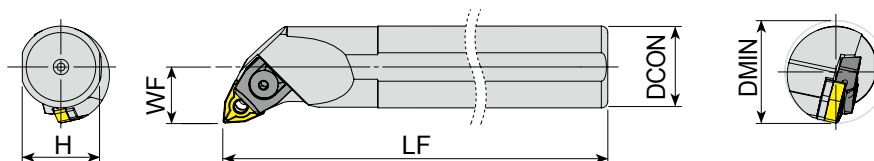

* 'C' Letter at Last : Optional Clamp Included

: p.53 Unit:mm

Series	Designation	EDP 2700..		DMIN	DCON	H	WF	LF	Insert
		R	L						
X	S16P - MWLNR/L 06	1064	1065	20	16	14.8	11	170	WN0604
	S20R - MWLNR/L 06	1066	1067	25	20	18.3	13	200	
	S25S - MWLNR/L 06	1068	1069	32	25	23	17	250	
X	S25S - MWLNR/L 08	1070	1071	32	25	23	17	250	WN0804
	S32T - MWLNR/L 08	1072	1073	40	32	30	22	300	
	S40U - MWLNR/L 08	1074	1075	50	40	37.5	27	350	

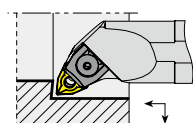

..-MWLNR/L

Approach angle
95°

Series	Designation	Infomation	Clamp	Clamp Screw	Upper Ring	Lower Ring	Pin	Shim	Allen Key
..16..06	Description	YAMK-01	YAMK-01	YAKV-17-M5x15	-	-	YAPM-09	-	-
	EDP	18000070	18000070	18000087			18000115		
..20..06	Description	YAMK-01	YAMK-01	YAKV-04-M5x17	-	-	YAPM-10	-	-
	EDP	18000070	18000070	18000082			18000116		
..25..06	Description	YAMK-01	YAMK-01	YAKV-04-M5x17	-	-	YAPM-08	-	-
	EDP	18000070	18000070	18000082			18000114		
..25..08	Description	YAMK-05	YAMK-05	YAKV-27-M6x20	YABPL-01	YAS-01	YAPM-04	YAAWN-3-0001	YAAL-03-3
	EDP	18000073	18000073	18000090	18000058	18000052	18000113	18000151	18000061
..32~40..08	Description	YAMK-05	YAMK-05	YAKV-03-M6x22	YABPL-01	YAS-01	YAPM-02	YAAWN-3-0001	YAAL-03-3
	EDP	18000073	18000073	18000081	18000058	18000052	18000111	18000151	18000061

Turning - Holder - Internal

Top Clamp type for KN Insert**

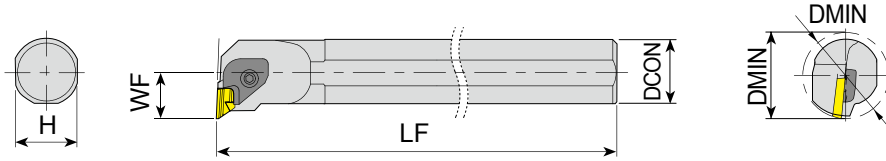

 : p. 41

Unit:mm

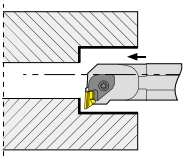
Series	Designation	EDP 2700..		DMIN	DCON	H	WF	LF	Insert
		R	L						
 <p>..-CKUNR/L Approach angle 93°</p>	S32T - CKUNR/L16	0952	0953	40	32	30	22	300	KN1604
	S40U - CKUNR/L16	0954	0955	50	40	37.5	27	350	
	S50V - CKUNR/L16	0956	0957	63	50	47	35	400	

TURNING

PARTING & GROOVING

MILLING

DRILLING

TECHNICAL INFORMATION

Series	Designation	Infomation	Clamp	Clamp Screw	Spring	Upper Ring	Shim	Shim Screw	Allen Key
..CK..	..16	Description	YACK-01-R	YAKV-06-M6x20	YAKY-02	YABPL-01	YAKS-16-R	YAAV-01-M3x10	YAAL-05-4
			YACK-02-L				YAKS-16-L		
		EDP	18000064 (18000063)	18000083	18000164	18000058	18000154 (18000153)	18000155	18000062

Screw on type for CC** Insert

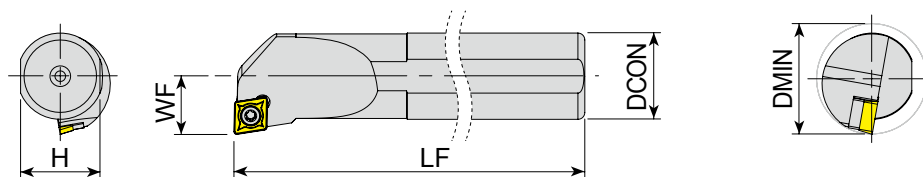

□: p. 57

Unit:mm

Series	Designation	EDP 2700..		DMIN	DCON	H	WF	LF	Insert
		R	L						
	S08H - SCFCR/L 06	1102	1103	11	08	7.3	6	100	CC0602
X	S10K - SCFCR/L 06	1104	1105	13	10	9	7	125	
	S12K - SCFCR/L 06	1106	1107	16	12	11	9	125	
	S12K - SCFCR/L 09	1108	1109	16	12	11	9	125	CC09T3
X	S16P - SCFCR/L 09	1110	1111	20	16	14.8	11	170	
	S20R - SCFCR/L 09	1112	1113	25	20	18.3	13	200	
	S25S - SCFCR/L 09	1114	1115	32	25	23	17	250	CC1204
X	S25S - SCFCR/L 12	1116	-	32	25	23	17	250	

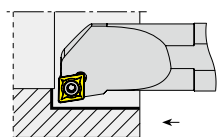

..- SCFCR/L

Approach angle 91°

▶ NEXT PAGE

Series	Designation	Infomation	Screw	Shim	Shim Screw	Torx Key
..06	Descritpion		Y4008-M2.5x6	-	-	Y80-T08
	EDP		18000127	-	-	18000165
..12	Descritpion		Y4020-M4.5x12	YAACN-2-0003	YAAV-10-M4.5x8	Y80-T20
	EDP		18000134	18000136	18000162	18000168
..SC..	Descritpion		Y4015-M3.5x8	-	-	Y80-T15
	EDP		18000130	-	-	18000167
..16~20..09	Descritpion		Y4015-M3.5x9	-	-	Y80-T15
	EDP		18000131	-	-	18000167
..25..09	Descritpion		Y4015-M3.5x12	YAACN-2-0001	YAAV-08-M3.5x8	Y80-T15
	EDP		18000128	18000135	18000161	18000167

Turning - Holder - Internal

Screw on type for CC Insert**

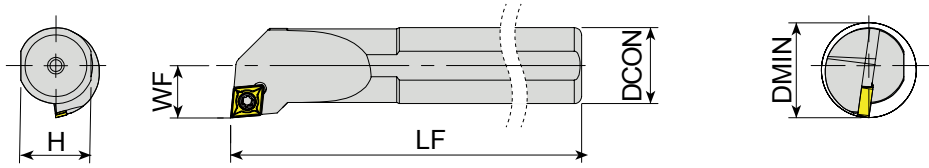

: p.57

Unit:mm

Series	Designation	EDP 2700.. R L	DMIN	DCON	H	WF	LF	Insert		
●	A08H - SCLCR/L 06	1117 1118	11	08	7.3	6	100	CC0602		
	A10H - SCLCR/L 06	1119 1120	13	10	9	7	100			
	A12H - SCLCR/L 06	1121 1122	16	12	11	9	100			
	S08H - SCLCR/L 06	1133 1134	11	08	7.3	6	100			
	X	S10K - SCLCR/L 06	1135 1136	13	10	9	7		125	
		S12K - SCLCR/L 06	1137 1138	16	12	11	9		125	
		S16P - SCLCR/L 06	1139 1140	20	16	14.8	11		170	
	●	A16M - SCLCR/L 09	1123 1124	20	16	14.8	11		150	CC09T3
		A20P - SCLCR/L 09	1125 1126	25	20	18.3	13		170	
		A25R - SCLCR/L 09	1127 1128	32	25	23	17		200	
A32S - SCLCR/L 09		1129 1130	40	32	30	22	250			
X		S12K - SCLCR/L 09	1141 1142	16	12	11	9	125		
		S16P - SCLCR/L 09	1474 1143	20	16	14.8	11	170		
		S20R - SCLCR/L 09	1144 1145	25	20	18.3	13	200		
		S25S - SCLCR/L 09	1146 1147	32	25	23	17	250		
		S32T - SCLCR/L 09	1148 1149	40	32	30	22	300		
●		A25R - SCLCR/L 12	1131 1132	32	25	23	17	200	CC1204	
	S25S - SCLCR/L 12	1150 1151	32	25	23	17	250			
	X	S32T - SCLCR/L 12	1152 1153	40	32	30	22	300		
		S40U - SCLCR/L 12	1154 1155	50	40	37.5	27	350		
●	E08K - SCLCR/L 06	0325 1156	11	08	7.3	6	125	CC0602		
	E12Q - SCLCR/L 06	1157 1158	16	12	11	9	180			
	●	E16R - SCLCR/L 09	0329 1159	20	16	14.8	11	200	CC09T3	
		E20S - SCLCR/L 09	1160 1161	24	20	18.3	13	250		

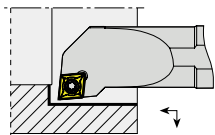

..-SCLCR/L

Approach angle
95°

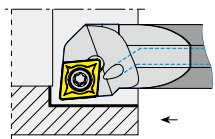

E..-SCLCR/L
(Carbide Shank)

Approach angle
95°

Series	Designation	Information	Screw	Shim	Shim Screw	Torx Key
..SC..	..06	Description	Y4008-M2.5x6	-	-	Y80-T08
		EDP	18000127	-	-	18000165
	..12..09	Description	Y4015-M3.5x8	-	-	Y80-T15
		EDP	18000130	-	-	18000167
	..16~20..09	Description	Y4015-M3.5x9	-	-	Y80-T15
		EDP	18000131	-	-	18000167
	..25~32..09	Description	Y4015-M3.5x12	YAACN-2-0001	YAAV-08-M3.5x8	Y80-T15
		EDP	18000128	18000135	18000161	18000167
	..25~32..12	Description	Y4020-M4.5x12	YAACN-2-0003	YAAV-10-M4.5x8	Y80-T20
		EDP	18000134	18000136	18000162	18000168
..40..12	Description	Y1020-M4.5x16	YAACN-2-0003	YAAV-07-M4.5x13	Y80-T20	
	EDP	18000120	18000136	18000160	18000168	
E..SC..	..06	Description	Y4008-M2.5x6	-	-	Y80-T08
		EDP	18000127	-	-	18000165
	..09	Description	Y4015-M3.5x9	-	-	Y80-T15
	EDP	18000131	-	-	18000167	

Turning - Holder - Internal

Screw on type for DC** Insert

..SDQCR Shown

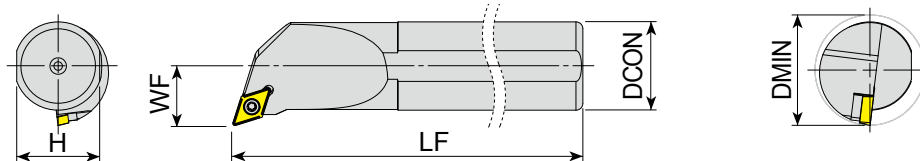

: p. 59 Unit:mm

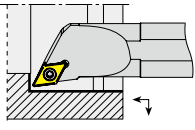
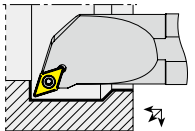
Series	Designation	EDP 2700..		DMIN	DCON	H	WF	LF	Insert
		R	L						
 ..SDPCR/L Approach angle 117.5°	S10K - SDPCR/L07	1162	1163	13	10	9	7	125	DC0702
	S12K - SDPCR/L07	1164	1165	16	12	11	9	125	
	S16P - SDPCR/L11	1166	1167	20	16	14.8	11	170	DC11T3
	S25S - SDPCR/L11	1170	1171	32	25	23	17	250	
 ..SDQCR/L Approach angle 107.5°	A10H - SDQCR/L 07	1172	1173	13	10	9	7	100	DC0702
	A12H - SDQCR/L 07	1174	1175	16	12	11	9	100	
	A16M - SDQCR/L 07	1176	1177	20	16	14.8	11	150	
	A20P - SDQCR/L 07	1178	1179	25	20	18.3	13	170	
	S10K - SDQCR/L 07	1188	1189	13	10	9	7	125	
	S12K - SDQCR/L 07	1190	1191	16	12	11	9	125	
	X S16P - SDQCR/L 07	1192	1193	20	16	14.8	11	170	DC11T3
	S20R - SDQCR/L 07	1194	1195	25	20	18.3	13	200	
	A16M - SDQCR/L 11	1180	1181	20	16	14.8	11	150	
	A20P - SDQCR/L 11	1182	1183	25	20	18.3	13	170	
	A25R - SDQCR/L 11	1184	1185	32	25	23	17	200	
	A32S - SDQCR/L 11	1186	1187	40	32	30	22	250	
S16P - SDQCR/L 11	1196	1197	20	16	14.8	11	170	DC11T3	
S20R - SDQCR/L 11	1198	1199	25	20	18.3	13	200		
X S25S - SDQCR/L 11	1200	1201	32	25	23	17	250		
S32T - SDQCR/L 11	1202	1203	40	32	30	22	300		
S40U - SDQCR/L 11	1204	1205	50	40	37.5	27	350		

▶ NEXT PAGE

Series	Designation	Information	Screw	Shim	Shim Screw	Torx Key
..07	Descritpion		Y4008-M2.5x6	-	-	Y80-T08
	EDP		18000127	-	-	18000165
..11	Descritpion		Y4008-M2.5x6	-	-	Y80-T15
	EDP		18000127	-	-	18000167
..16..11	Descritpion		Y4015-M3.5x9	-	-	Y80-T15
	EDP		18000131	-	-	18000167
..20..11	Descritpion		Y4015-M3.5x11	-	-	Y80-T15
	EDP		18000118	-	-	18000167
..25..11	Descritpion		Y4015-M3.5x12	YAADN-2-0001	YAAV-08-M3.5x8	Y80-T15
	EDP		18000128	18000140	18000162	18000167
..32..11	Descritpion		Y4015-M3.5x14	YAADN-2-0001	YAAV-06-M3.5x11	Y80-T15
	EDP		18000129	18000140	18000159	18000162

Turning - Holder - Internal

Screw on type for DC** Insert

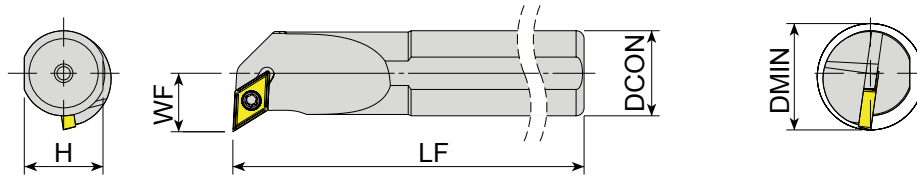

: p. 59 Unit: mm

Series	Designation	EDP 2700.. R L	DMIN	DCON	H	WF	LF	Insert		
●	A10H - SDUCR/L 07	1206 1207	13	10	9	8	100	DC0702		
	A12H - SDUCR/L 07	1208 1209	16	12	11	9	100			
	A16M - SDUCR/L 07	1210 1211	20	16	14.8	11	150			
	A20P - SDUCR/L 07	1212 1213	25	20	18.3	13	170			
	S10K - SDUCR/L 07	1222 1223	13	10	9	8	125			
	S12K - SDUCR/L 07	1224 1225	16	12	11	9	125			
	S16P - SDUCR/L 07	1226 1227	20	16	14.8	11	170			
	S20R - SDUCR/L 07	1228 1229	25	20	18.3	13	200			
	X	A16M - SDUCR/L 11	1214 1215	20	16	14.8	11		150	DC11T3
		A20P - SDUCR/L 11	1216 1217	25	20	18.3	13		170	
A25R - SDUCR/L 11		1218 1219	32	25	23	17	200			
A32S - SDUCR/L 11		1220 1221	40	32	30	22	250			
S16P - SDUCR/L 11		1230 1231	20	16	14.8	11	170			
S20R - SDUCR/L 11		1232 1233	25	20	18.3	13	200			
S25S - SDUCR/L 11		1234 1235	32	25	23	17	250			
S32T - SDUCR/L 11		1236 1237	40	32	30	22	300			
S40U - SDUCR/L 11		1238 1239	50	40	37.5	27	350			
S50V - SDUCR/L 11		- 1240	63	50	47	35	400			
●	E10M - SDUCR/L 07	1241 1242	13	10	9	8	150	DC0702		
	E12Q - SDUCR/L 07	1243 1244	16	12	11	9	180			
	E16R - SDUCR/L 11	0339 1245	20	16	14.8	11	200	DC11T3		
	E20S - SDUCR/L 11	1246 1247	23	20	18.3	12	250			

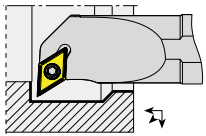

..SDUCR/L
Approach angle 93°

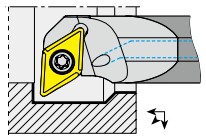

E..SDUCR/L
(Carbide Shank)
Approach angle 93°

Series	Designation	Information	Screw	Shim	Shim Screw	Torx Key
..SD..	..07	Description	Y4008-M2.5x6	-	-	Y80-T08
		EDP	18000127	-	-	18000165
	..16..11	Description	Y4015-M3.5x9	-	-	Y80-T15
		EDP	18000131	-	-	18000167
	..20..11	Description	Y4015-M3.5x11	-	-	Y80-T15
		EDP	18000118	-	-	18000167
..25..11	Description	Y4015-M3.5x12	YAADN-2-0001	YAAV-08-M3.5x8	Y80-T15	
	EDP	18000128	18000140	18000161	18000167	
..32..11	Description	Y4015-M3.5x14	YAADN-2-0001	YAAV-06-M3.5x11	Y80-T15	
	EDP	18000129	18000140	18000159	18000167	
E..SD..	..07	Description	Y4008-M2.5x6	-	-	Y80-T08
		EDP	18000127	-	-	18000165
	..11	Description	Y4015-M3.5x9	-	-	Y80-T15
		EDP	18000131	-	-	18000167

Screw on type for RC** Insert

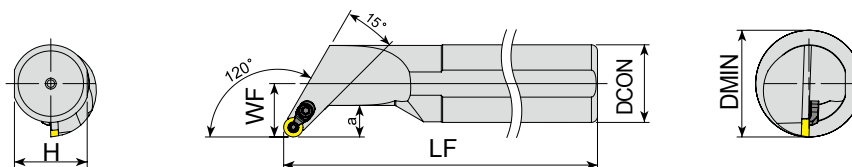

: p.61 Unit:mm

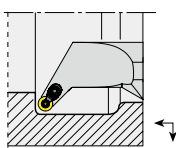
Series	Designation	EDP 2700..		DMIN	DCON	H	WF	LF	Insert
		R	L						
 ..-SRGCR/L	X S16P - SRGCR/L08	1248	-	22	16	14.8	11	170	RC0803
	S40U - SRGCR 08C	1254	-	54	40	37.5	27	350	
	● S32T - SRGCR/L08C	1253	-	44	32	30	22	300	
	S25S - SRGCR/L08C	1251	1252	34	25	23	17	250	

Series	Designation	Information	Screw	Clamp	Clamp Screw	Torx Key
..SR..	..08	Description	Y3008-M3x8	-	-	Y80-T08
		EDP	18000125			18000165
	..08C	Description	Y3008-M3x8	YACK-15	Y4015-M3.5x11	Y80-T08
		EDP	18000125	18000069	18000118	18000165

Turning - Holder - Internal

Screw on type for SC** Insert

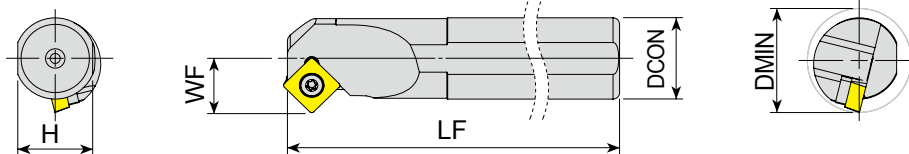

: p. 63 Unit: mm

Series	Designation	EDP 2700.. R L	DMIN	DCON	H	WF	LF	Insert
 .. - SSSCR/L Approach angle 45°	S16P - SSSCR/L09	1255 1256	20	16	14.8	11	170	SC09T3
	S25S - SSSCR/L09	1259 1260	32	25	23	17	250	
	S25S - SSSCR/L12	1261 1262	32	25	23	17	250	SC1204
	S32T - SSSCR12	1263 -	40	32	30	22	300	

TURNING

PARTING & GROOVING

MILLING

DRILLING

TECHNICAL INFORMATION

Series	Designation	Infomation	Screw	Shim	Shim Screw	Torx Key
..SS..	..16..09	Description	Y4015-M3.5x9	-	-	Y80-T15
		EDP	18000131			18000167
	..25..09	Description	Y4015-M3.5x12	YAASN-2-0001	YAAV-08-M3.5x8	Y80-T15
		EDP	18000128	18000143	18000161	18000167
	..25..12	Description	Y4020-M4.5x12	YAASN-2-0004	YAAV-10-M4.5x8	Y80-T20
		EDP	18000134	18000144	18000162	18000168
..32..12	Description	Y1020-M4.5x16	YAASN-2-0004	YAAV-10-M4.5x8	Y80-T20	
	EDP	18000120	18000144	18000162	18000168	

Turning - Holder - Internal

Screw on type for TC** Insert

..STFCR Shown

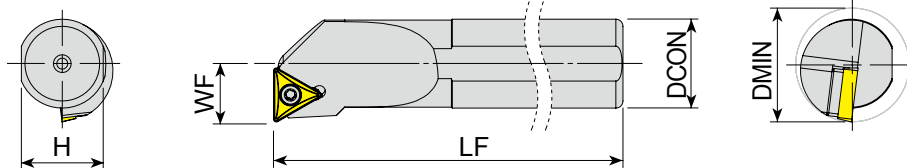

: p. 64 Unit:mm

Series	Designation	EDP 2700..		DMIN	DCON	H	WF	LF	Insert	
		R	L							
 ..STFCR/L Approach angle 91°	X S12K - STFCR/L 11	1264	1265	17	12	11	9	125	TC1102	
	S16P - STFCR/L 11	1266	1267	20	16	14.8	11	170		
	S20R - STFCR/L 11	1268	1269	25	20	18.3	13	200		
	 ..STUCR/L Approach angle 93°	S16P - STFCR/L 16	1270	1271	20	16	14.8	11	170	TC16T3
		X S20R - STFCR/L 16	1272	1273	25	20	18.3	13	200	
		S25S - STFCR/L 16	1274	1275	32	25	23	17	250	
		S32T - STFCR/L 16	1276	1277	40	32	30	22	300	
S40U - STFCR/L 16		1278	-	50	40	37.5	27	350		
X S12K - STUCR/L 11		1279	1280	17	12	11	9	125	TC1102	
S16P - STUCR/L 11		1281	1282	20	16	14.8	11	170		
S20R - STUCR/L 11	1283	1284	25	20	18.3	13	200			
 ..STUCR/L Approach angle 93°	S16P - STUCR/L 16	1285	1286	20	16	14.8	11	170	TC16T3	
	X S20R - STUCR/L 16	1287	1288	25	20	18.3	13	200		
	S25S - STUCR/L 16	1289	1290	32	25	23	17	250		
	S32T - STUCR/L 16	1291	1292	40	32	30	22	300		
	S40U - STUCR/L 16	1293	1294	50	40	37.5	27	350		

Series	Designation	Information	Screw	Shim	Shim Screw	Torx Key
..11	Description		Y4008-M2.5x6	-	-	Y80-T08
	EDP		18000127	-	-	18000165
..12~20..11	Description		Y4008-M2.5x6	-	-	Y80-T08
	EDP		18000127	-	-	18000165
..16..16	Description		Y4015-M3.5x9	-	-	Y80-T15
	EDP		18000131	-	-	18000167
..20..16	Description		Y4015-M3.5x11	-	-	Y80-T15
	EDP		18000118	-	-	18000167
..25..16	Description		Y4015-M3.5x14	YAATN-2-0001	YAAV-08-M3.5x8	Y80-T15
	EDP		18000129	18000146	18000161	18000167
..32~40..16	Description		Y4015-M3.5x14	YAATN-2-0001	YAAV-06-M3.5x11	Y80-T15
	EDP		18000129	18000146	18000159	18000167

Turning - Holder - Internal

Screw on type for VB Insert**

..STFCR Shown

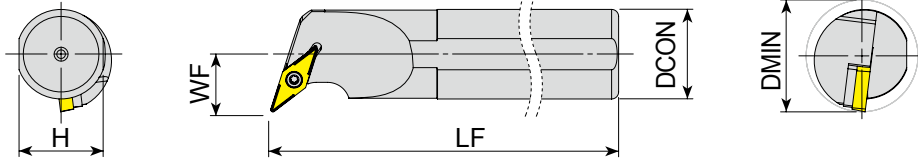

: p. 66 Unit: mm

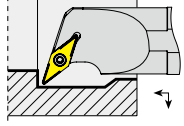
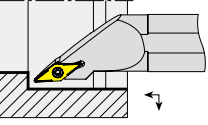
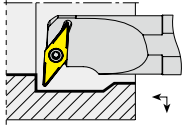
Series	Designation	EDP 2700.. R L	DMIN	DCON	H	WF	LF	Insert
 ..-SVQBR/L Approach angle 107.5°	● A20Q - SVQBR/L 16	1299 1300	30	20	18.3	20	180	VB1604
	● A25S - SVQBR/L 16	1301 1302	32	25	23	17	250	
	● A32S - SVQBR/L 16	1303 1304	40	32	30	22	250	
	● S25S - SVQBR/L 16	1305 1306	32	25	23	17	250	
	X S32T - SVQBR/L 16	1307 1308	40	32	30	22	300	
	● S40U - SVQBR/L 16	1309 1310	50	40	37.5	27	350	
 ..-SVJBR/L Approach angle 93°	S25S - SVJBR/L 16	1295 1296	32	25	23	17	250	VB1604
	X S32T - SVJBR/L 16	1297 1298	40	32	30	22	300	
 ..-SVUBR/L Approach angle 93°	● A20Q - SVUBR/L 16	1311 -	30	20	18.3	20	180	VB1604
	● A32S - SVUBR/L 16	1312 1313	40	32	30	22	250	
	● S25S - SVUBR/L 16	1314 1315	32	25	23	19	250	
	X S32T - SVUBR/L 16	1316 1317	40	32	30	22	300	
	● S40U - SVUBR/L 16	1318 1319	50	40	37.5	27	350	

Series	Designation	Infomation	Screw	Shim	Shim Screw	Torx Key
..20..16	Description		Y4015-M3.5x11	-	-	Y80-T15
	EDP		18000118	-	-	18000167
A - ..25..16	Description		Y4015-M3.5x14	YAAVN-2-0002	YAAV-06-M3.5x11	Y80-T15
	EDP		18000129	18000150	18000159	18000167
S - ..25..16	Description		Y4015-M3.5x14	YAAVN-2-0002	YAAV-08-M3.5x8	Y80-T15
	EDP		18000129	18000150	18000161	18000167
..32~40..16	Description		Y4015-M3.5x14	YAAVN-2-0002	YAAV-06-M3.5x11	Y80-T15
	EDP		18000129	18000150	18000159	18000167
..16	Description		Y4015-M3.5x12	YAAVN-2-0002	YAAV-08-M3.5x8	Y80-T15
	EDP		18000128	18000150	18000161	18000167
..25~40..16	Description		Y4015-M3.5x14	YAAVN-2-0002	YAAV-06-M3.5x11	Y80-T15
	EDP		18000129	18000150	18000159	18000167

Turning - Holder - Internal

Screw on type for VC** Insert

..SVQCR Shown

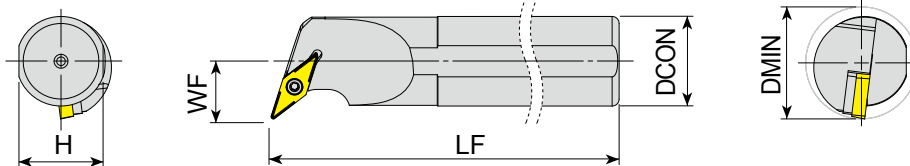

: p.67 Unit:mm

Series	Designation	EDP 2700..		DMIN	DCON	H	WF	LF	Insert	
		R	L							
 ..SVQCR/L Approach angle 107.5°		S25S - SVQCR/L 16	1320	1321	32	25	23	17	250	VC1604
	X	S32T - SVQCR/L 16	1322	1323	40	32	30	22	300	
		S40U - SVQCR/L 16	1324	1325	50	40	37.5	27	350	
 ..SVUCR/L Approach angle 93°	X	S16P - SVUCR/L11	1495	1496	20	16	14.8	12.5	170	VC1103
		S20R - SVUCR/L11	1497	1498	25	20	18.3	13	200	VC1103
	●	A25R - SVUCR/L 16	1326	-	32	25	23	19	200	VC1604
		S25S - SVUCR/L 16	1327	1328	32	25	23	19	250	
	X	S32T - SVUCR/L 16	1329	1330	40	32	30	22	300	
		S40U - SVUCR/L 16	1331	1332	50	40	37.5	27	350	

Series	Designation	Information	Screw	Shim	Shim Screw	Torx Key
..11	Descritpion		Y4008-M2.5x6	-	-	Y80-T08
	EDP		18000127	-	-	18000165
..16	Descritpion		Y4015-M3.5x14	YAAVN-2-0002	YAAV-06-M3.5x11	Y80-T15
	EDP		18000129	18000150	18000159	18000167
..25..16	Descritpion		Y4015-M3.5x14	YAAVN-2-0002	YAAV-08-M3.5x8	Y80-T15
	EDP		18000129	18000150	18000161	18000167
..32~40..16	Descritpion		Y4015-M3.5x14	YAAVN-2-0002	YAAV-06-M3.5x11	Y80-T15
	EDP		18000129	18000150	18000159	18000167



PARTING & GROOVING

Parting & Grooving Inserts Overview

Parting & Grooving Inserts

Parting & Grooving Holders

Parting & Grooving Overview

Parting & Groove Turn Grades



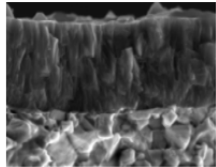
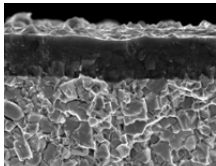







Parting and Grooving Grades		P Steel				M Stainless steel				K Cast iron			N Non Ferrous		S Super Alloy	
		P10	P20	P30	P40	M10	M20	M30	M40	K10	K20	K30	N10	N20	S10	S20
PVD	YG602G (YG602)		602G				602G				602G					602G
	YG603						603									

<p>YG602G (YG602)</p> <p>P20 - P35 M20 - M40 K20 - K40 S15 - S25</p>	<p>PVD - TiAlN</p> 	<p>Universal grade for Parting & Groove Turn</p> <ul style="list-style-type: none"> Ultra Dense PVD Coating with optimal thermal resistance & strength Sub-Micron substrate designed for demanding application YG602G : First Choice for Low Cutting Speed, Soft and Sticky Material with Low Hardness (Gold Color) YG602 : First Choice for General Application (Violet Color)
<p>YG603</p> <p>M30 - M50</p>	<p>PVD - TiAlN</p> 	<p>PVD Parting & Grooving Grade for Stainless Steel</p> <ul style="list-style-type: none"> Ultra high toughness substrate and strong adhesion Excellent cutting edge strength and chipping resistance Stable machinability and tool life for stainless steel

Parting & Grooving Inserts

	TD. Series	Inserts TDN, TDP, TDY	2, 3, 4, 5
---	------------	---------------------------------	------------

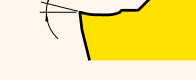
Parting & Grooving Chipbreakers

Parting & Grooving	-P			<ul style="list-style-type: none"> For Parting & Deep Grooving For General Use
	-N			<ul style="list-style-type: none"> For External Parting And Grooving For Low Feed Rate and Difficult to Cut Materials
Turning & Grooving	-Y			<ul style="list-style-type: none"> For External Turning & Grooving For Medium feed rate
	NEW GL			<ul style="list-style-type: none"> For External, Internal turning and Grooving Face grooving and Face turning For low feed rate
	NEW GM			<ul style="list-style-type: none"> For External, Internal turning and Grooving First choice Face Grooving and Face turning For Medium feed rate
	NEW RG			<ul style="list-style-type: none"> For External, Internal turning and Grooving Full radius Insert for Profiling

Parting & Grooving - Inserts

Parting & Grooving Inserts

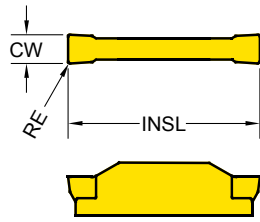

Recommended Cutting Conditions : p.222



Series	INSL	CW
TD* 2	20	2
TD* 3	20	3
TD* 4	20	4
TD* 5	25	5

* CDX : Cutting Depth Maximum

● : Stock item ○ : Order made item

TD.	Designation	RE	Parting & Grooving		Turning		EDP 5200..		
			Fn (mm/rev.)	CDX (mm)	Fn (mm/rev.)	Ap (mm)	YG602	YG602G	YG603
-P  Parting & Grooving (Sharp edge)	TDP 2002	0.2	0.04 ~ 0.12	19	-	-	● 0012	○ 0036	● 0078
	TDP 3002	0.2	0.05 ~ 0.16	19	-	-	● 0029	○ 0030	● 0076
	TDP 4003	0.3	0.06 ~ 0.18	19	-	-	● 0023	○ 0038	● 0080
	TDPR 2002 - 6	0.2	0.03 ~ 0.08	19	-	-	● 0045		● 0085
	TDPR 3002 - 6	0.2	0.04 ~ 0.12	19	-	-	● 0048		● 0089
	TDPL 2002 - 6	0.2	0.03 ~ 0.08	19	-	-	● 0046		● 0086
	TDPL 3002 - 6	0.2	0.04 ~ 0.12	19	-	-	● 0049		● 0090
-N  Parting & Grooving (General)	TDN 2002	0.2	0.05 ~ 0.18	19	-	-	● 0010	○ 0035	● 0077
	TDN 3002	0.2	0.07 ~ 0.23	19	-	-	● 0024	○ 0025	● 0075
	TDN 4003	0.3	0.08 ~ 0.28	19	-	-	● 0022	○ 0037	● 0079
	TDN 5003	0.3	0.09 ~ 0.35	24	-	-	● 0042		
	TDNR 2002 - 6	0.2	0.04 ~ 0.14	19	-	-	● 0043		● 0083
	TDNR 3002 - 6	0.2	0.06 ~ 0.18	19	-	-	● 0040		● 0087
	TDNL 2002 - 6	0.2	0.04 ~ 0.14	19	-	-	● 0044		● 0084
	TDNL 3002 - 6	0.2	0.06 ~ 0.18	19	-	-	● 0047		● 0088
-Y  Turn Groove	TDY3E - 0.4	0.4	0.06 ~ 0.24	10	0.12 ~ 0.22	0.5 ~ 2.4		● 0027	
	TDY4E - 0.4	0.4	0.08 ~ 0.27	10	0.15 ~ 0.30	0.5 ~ 2.8		● 0020	
	TDY5E - 0.4	0.4	0.08 ~ 0.23	10	0.15 ~ 0.30	0.5 ~ 3.2		● 0082	
	TDY2E - 0.3 - GL	0.3	0.04 ~ 0.20	10	0.06 ~ 0.18	0.4 ~ 1.5		● 0123	● 0124
	TDY3E - 0.3 - GL	0.3	0.05 ~ 0.23	10	0.08 ~ 0.20	0.4 ~ 2.0		● 0125	● 0126
	TDY4E - 0.4 - GL	0.4	0.06 ~ 0.26	10	0.10 ~ 0.25	0.5 ~ 2.3		● 0112	● 0127
	TDY3E - 0.4 - GM	0.4	0.06 ~ 0.24	10	0.12 ~ 0.22	0.5 ~ 2.4		● 0118	● 0119
	TDY4E - 0.4 - GM	0.4	0.08 ~ 0.27	10	0.15 ~ 0.30	0.5 ~ 2.8		● 0113	● 0120
	TDY4E - 0.8 - GM	0.8	0.10 ~ 0.27	10	0.18 ~ 0.32	0.8 ~ 2.8		● 0114	● 0122
	TDY2E - 1.0 - RG	1.0	0.05 ~ 0.15	10	0.10 ~ 0.30	0.1 ~ 0.8		● 0111	● 0115
TDY3E - 1.5 - RG	1.5	0.08 ~ 0.18	10	0.15 ~ 0.35	0.1 ~ 1.2		● 0108	● 0116	
TDY4E - 2.0 - RG	2.0	0.10 ~ 0.20	10	0.18 ~ 0.45	0.1 ~ 1.6		● 0109	● 0117	

External holders

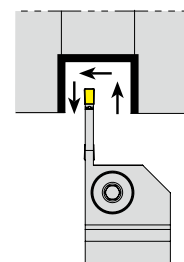
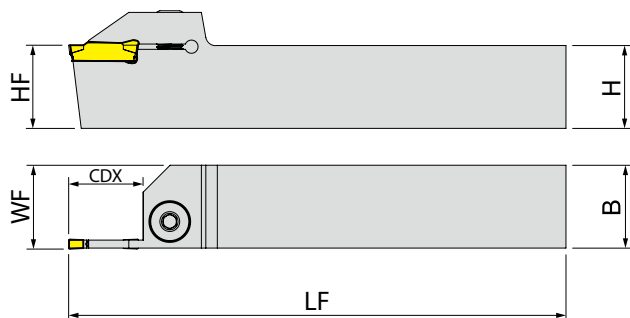

 : p. 119 Unit : mm

Designation	EDP 5700..		CW	CDX	H (= HF)	B	LF	WF	Insert
	R	L							
YTER/L 1212 - 2T15	0025	0024	2	15	12	12	100	12.3	TD.2..
YTER/L 1616 - 2T15	0027	0026	2	15	16	16	125	16.3	
YTER/L 2020 - 2T15	0030	0029	2	15	20	20	125	20.3	
YTER/L 2020 - 2T20	0032	0031	2	20	20	20	125	20.3	
YTER/L 2020 - 2T9	0028	-	2	9	20	20	125	20.3	
YTER/L 2525 - 2T17	0034	0033	2	17	25	25	150	25.3	
YTER/L 1212 - 3T15	0036	0035	3	15	12	12	100	12.4	TD.3..
YTER/L 1616 - 3T15	0038	0037	3	15	16	16	125	16.4	
YTER/L 2020 - 3T20	0040	0039	3	20	20	20	125	20.4	
YTER/L 2525 - 3T20	0044	0043	3	20	25	25	150	25.4	
YTER/L 2525 - 3T9	0042	0041	3	9	25	25	150	25.4	
YTER/L 3232 - 3T20	0045	-	3	20	32	32	170	32.4	TD.4..
YTER/L 2525 - 4T20	0047	0046	4	20	25	25	150	25.5	

▶ NEXT PAGE

Series	Designation	Infomation	Screw	Ring	Wrench
YTER/L	..2..	Description	YAKV-02-M6x22	YABPL-01	YAAL-03-3
		EDP	18000195	18000058	18000061
	..3../..4../..5..	Description	Y2004-M8x1x20	-	YAAL-05-4
		EDP	18000196	-	18000062

Parting & Grooving - Holder - External

External holders

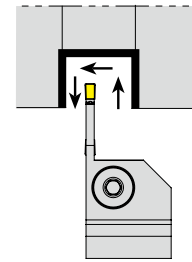
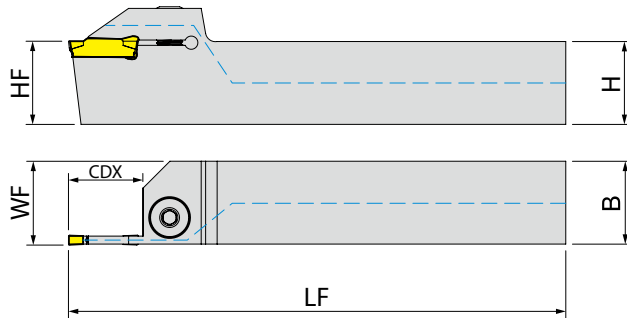

: p. 119 Unit : mm

Designation	●	EDP 5700.. R L	CW	CDX	H (= HF)	B	LF	WF	Insert
YTER/L 1212 - 2T15 - C	●	0194 0171	2	15	12	12	100	12.3	TD.2..
YTER/L 1616 - 2T15 - C	●	0197 0174	2	15	16	16	125	16.3	
YTER/L 2020 - 2T15 - C	●	0201 0178	2	15	20	20	125	20.3	
YTER/L 2020 - 2T17 - C	●	0202	2	17	20	20	125	20.3	
YTER/L 2020 - 2T20 - C	●	0203 0179	2	20	20	20	125	20.3	
YTER/L 2020 - 2T09 - C	●	0204 0180	2	09	20	20	125	20.3	
YTER/L 2525 - 2T17 - C	●	0208 0184	2	17	25	25	150	25.3	TD.3..
YTER/L 1212 - 3T15 - C	●	0196 0173	3	15	12	12	100	12.4	
YTER/L 1616 - 3T15 - C	●	0199 0176	3	15	16	16	125	16.4	
YTER/L 2020 - 3T20 - C	●	0205 0181	3	20	20	20	125	20.4	
YTER/L 2020 - 3T25 - C	●	0206 0182	3	25	20	20	125	20.4	
YTER/L 2020 - 3T30 - C	●	0207 0183	3	30	20	20	125	20.4	
YTER/L 2525 - 3T22 - C	●	0209 0185	3	22	25	25	150	25.4	
YTER/L 2525 - 3T25 - C	●	0210 0186	3	25	25	25	150	25.4	
YTER/L 2525 - 3T30 - C	●	0211 0187	3	30	25	25	150	25.4	
YTER/L 2525 - 3T09 - C	●	0212 0188	3	09	25	25	150	25.4	
YTER/L 3232 - 3T25 - C	●	0217 0192	3	25	32	32	170	32.4	
YTER/L 2525 - 4T22 - C	●	0213 0189	4	22	25	25	150	25.5	
YTER/L 2525 - 4T25 - C	●	0214	4	25	25	25	150	25.5	
YTER/L 2525 - 4T30 - C	●	0215 0190	4	30	25	25	150	25.5	
YTER/L 2525 - 5T25 - C	●	0216 0191	5	25	25	25	150	25.5	TD.5..

Series	Designation	Infomation	Screw	Ring	Wrench
YTER/L	..2..	Description	YAKV-02-M6X22	YABPL-01	YAAL-03-3
		EDP	18000195	18000058	18000061
	..3../..4../..5..	Description	Y2004-M8X1X20	-	YAAL-05-4
		EDP	18000196	-	18000062

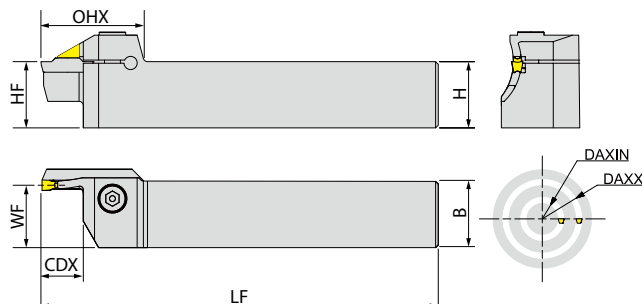

: p. 119 Unit :mm

Designation	EDP 5700.. R L	CW	DAXIN	DAXX	CDX	H (= HF)	B	LF	WF	Insert
YTFR 25M-D034050-3T10A	0599 -	3	34	50	10	25	25	150	24	TD3..
YTFR 25M-D044060-3T15A	0600 -	3	44	60	15	25	25	150	24	
YTFR 25M-D054085-3T15A	0601 -	3	54	85	15	25	25	150	24	
YTFR 25M-D034050-4T15A	0602 -	4	34	50	15	25	25	150	23.6	TD4..
YTFR 25M-D042060-4T15A	0603 -	4	42	60	15	25	25	150	23.6	
YTFR 25M-D052072-4T20A	0604 -	4	52	72	20	25	25	150	23.6	
YTFR 25M-D064120-4T20A	0605 -	4	64	120	20	25	25	150	23.6	
YTFR 25M-D112200-4T20A	0606 -	4	112	200	20	25	25	150	23.6	
YTFR 25M-D200-4T20A	0607 -	4	200	-	20	25	25	150	23.6	

Series	Designation	Infomation	Screw	Ring	Wrench
YTFR	..S	Description	SHB-M6x1.0x25L	-	HL-05
		EDP	58000039	-	58000041

Parting & Grooving - Holder - External

NEW

External holders - Perpendicular Face grooving

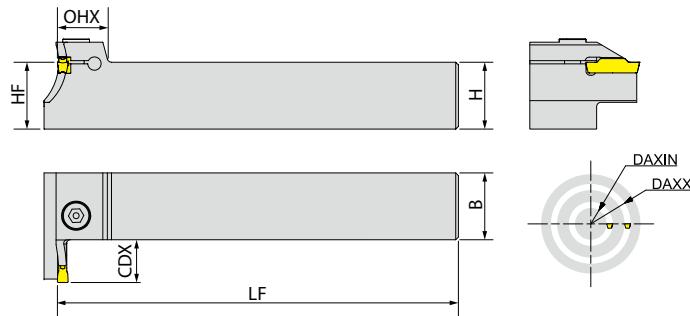

: p. 119 Unit : mm

Designation	EDP 5700.. R L	CW	DAXIN	DAXX	CDX	H (= HF)	B	LF	Insert
YTFPR25M - D034050 - 3T12A	0608 -	3	34	50	12	25	25	150	TD.3..
YTFPR25M - D044060 - 3T15A	0609 -	3	44	60	15	25	25	150	
YTFPR25M - D054085 - 3T15A	0610 -	3	54	85	15	25	25	150	
YTFPR25M - D034050 - 4T15A	0611 -	4	34	50	15	25	25	150	TD.4..
YTFPR25M - D042060 - 4T15A	0612 -	4	42	60	15	25	25	150	
YTFPR25M - D052072 - 4T20A	0613 -	4	52	72	20	25	25	150	
YTFPR25M - D064120 - 4T20A	0614 -	4	64	120	20	25	25	150	
YTFPR25M - D112200 - 4T20A	0615 -	4	112	200	20	25	25	150	

Series	Designation	Information	Screw	Ring	Wrench
YTFPR	16-2T..	Description	SHB-M6x1.0x25L	-	HL-05
		EDP	58000039	-	58000041
	20~25-3T..	Description	SHB-M6x1.0x25L	-	HL-05
		EDP	58000039	-	58000041
	32-3T..	Description	SHB-M6x1.0x25L	-	HL-05
		EDP	58000039	-	58000041

Parting & Grooving - Holder - External
External holders (Swiss Lathe)

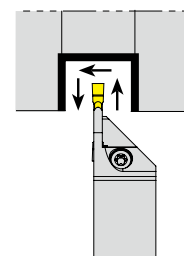
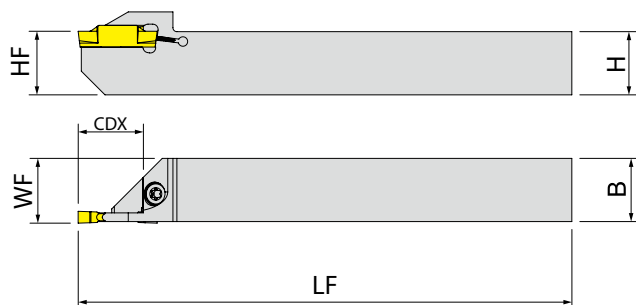

: p. 119 Unit : mm

Designation	EDP 5700..		CW	CDX	H (= HF)	B	LF	WF	Insert
	R	L							
YTER/L 1212-2T12-S	0048	-	2	12	12	12	125	12.2	TD.2..
YTER/L 1616-2T16-S	0049	-	2	16	16	16	125	16.2	
YTER/L 1212-3T12-S	0051	0050	3	12	12	12	125	12.3	TD.3..
YTER/L 1616-3T16-S	0053	0052	3	16	16	16	125	16.3	
YTER/L 1212-2T12-S-C	● 0193	0170	2	12	12	12	125	12.2	TD.2..
YTER/L 1616-2T16-S-C	● 0198	0175	2	16	16	16	125	16.2	
YTER/L 1212-3T12-S-C	● 0195	0172	3	12	12	12	125	12.3	TD.3..
YTER/L 1616-3T16-S-C	● 0200	0177	3	16	16	16	125	16.3	

TURNING

PARTING & GROOVING

MILLING

DRILLING

TECHNICAL INFORMATION

Series	Designation	Information	Screw	Ring	Wrench
YTER/L	..S	Description	Y4015-M4x11	-	Y80-T15
		EDP	18000119	-	18000167

Parting & Grooving - Holder - Internal

Internal holders with Coolant supply

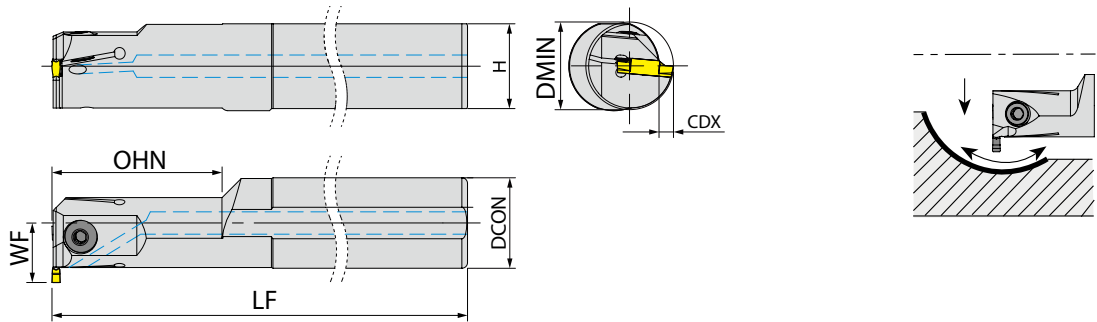

: p. 119 Unit : mm

Designation		EDP 5700.. R	L	CW	DMIN	CDX	DCON	H (= HF)	OHN	LF	WF	Insert
YTIR/L 16 - 2T8.5 - C	●	0222	0218	2	25	8.5	16	14.8	28	150	16.5	TD.2..
YTIR/L 20 - 3T06 - C	●	0223	0219	3	25	6	20	18.3	40	170	16	
YTIR/L 25 - 3T06 - C	●	0224	0220	3	25	6	25	23	40	200	18.5	TD.3..
YTIR/L 32 - 3T05 - C	●	0225	0221	3	31	5	32	30	60	250	21	

Series	Designation	Information	Screw	Ring	Wrench
YTIR/L	16-2T..	Description	Y2503-M4X10	-	YAAL-03-3
		EDP	18000197	-	18000061
	20-3T..	Description	Y2504-M5X12	-	YAAL-05-4
		EDP	18000198	-	18000062
	25-3T..	Description	Y2504-M5X16	-	YAAL-05-4
		EDP	58000028	-	18000062
32-3T..	Description	Y2004-M8X1X20	-	YAAL-05-4	
	EDP	18000196	-	18000062	

Parting & Grooving - Holder
Blade

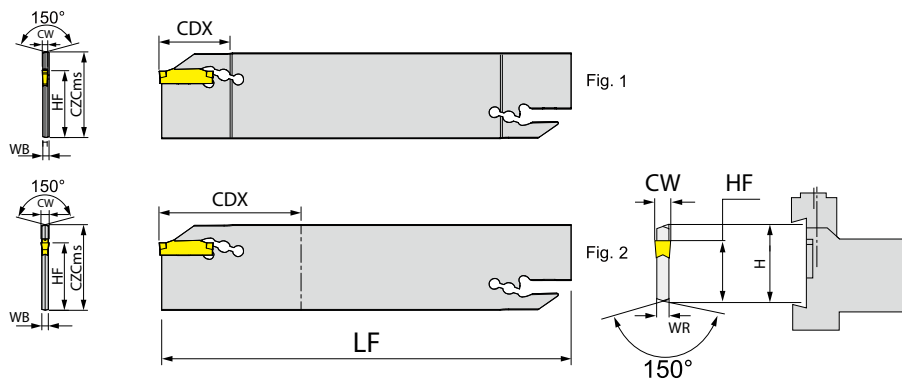

: p. 119 Unit:mm

Designation	EDP 5700..	CZCms	CW	CDX	HF	LF	WB	Insert	Fig
YGB 32 - 2	0058	32	2	25	25	150	2.4	TD.2..	1
YGB 32 - 3	0059	32	3	50	25	150	2.4	TD.3..	2
YGB 32 - 2 - C	● 0226	32	2	25	25	150	2.4	TD.2..	1
YGB 32 - 3 - C	● 0227	32	3	50	25	150	2.4	TD.3..	2

TURNING

PARTING & GROOVING

MILLING

DRILLING

TECHNICAL INFORMATION

Series	Designation	Information	Screw	Ring	Wrench
YGB..	..-32..	Description	-	-	YALA-02
		EDP	-	-	58000027

Parting & Grooving - Holder Blade Block

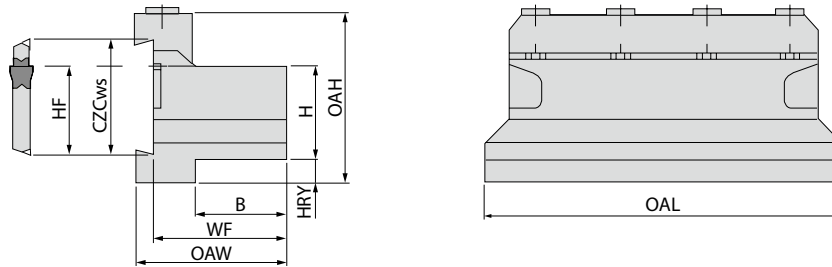

 : p.119 Unit:mm

Designation	EDP 5700..	CZCws	H	B	HF	WF	HRV	OAL	OAH	OAW
YGBU 20 - 32	0060	32	20	19	25	32.7	13	100	50	38
YGBU 25 - 32	0061	32	25	23	25	36.7	8	110	50	42
YGBU 32 - 32	0062	32	32	29	25	42.7	5	110	54	48
YGBU 20 - 32 - C	● 0228	32	20	19	25	32.7	13	100	50	38
YGBU 25 - 32 - C	● 0229	32	25	23	25	36.7	8	110	50	42
YGBU 32 - 32 - C	● 0230	32	32	29	25	42.7	5	110	54	48

Series	Designation	Infomation	Screw	Ring	Wrench
YGBU	20-32	Description	YABK-03	Y2505-M6X30	YAAL-07-5
		EDP	18000204	18000199	18000203
	25~32-32	Description	YABK-04	Y2505-M6X30	YAAL-07-5
		EDP	18000205	18000199	18000203

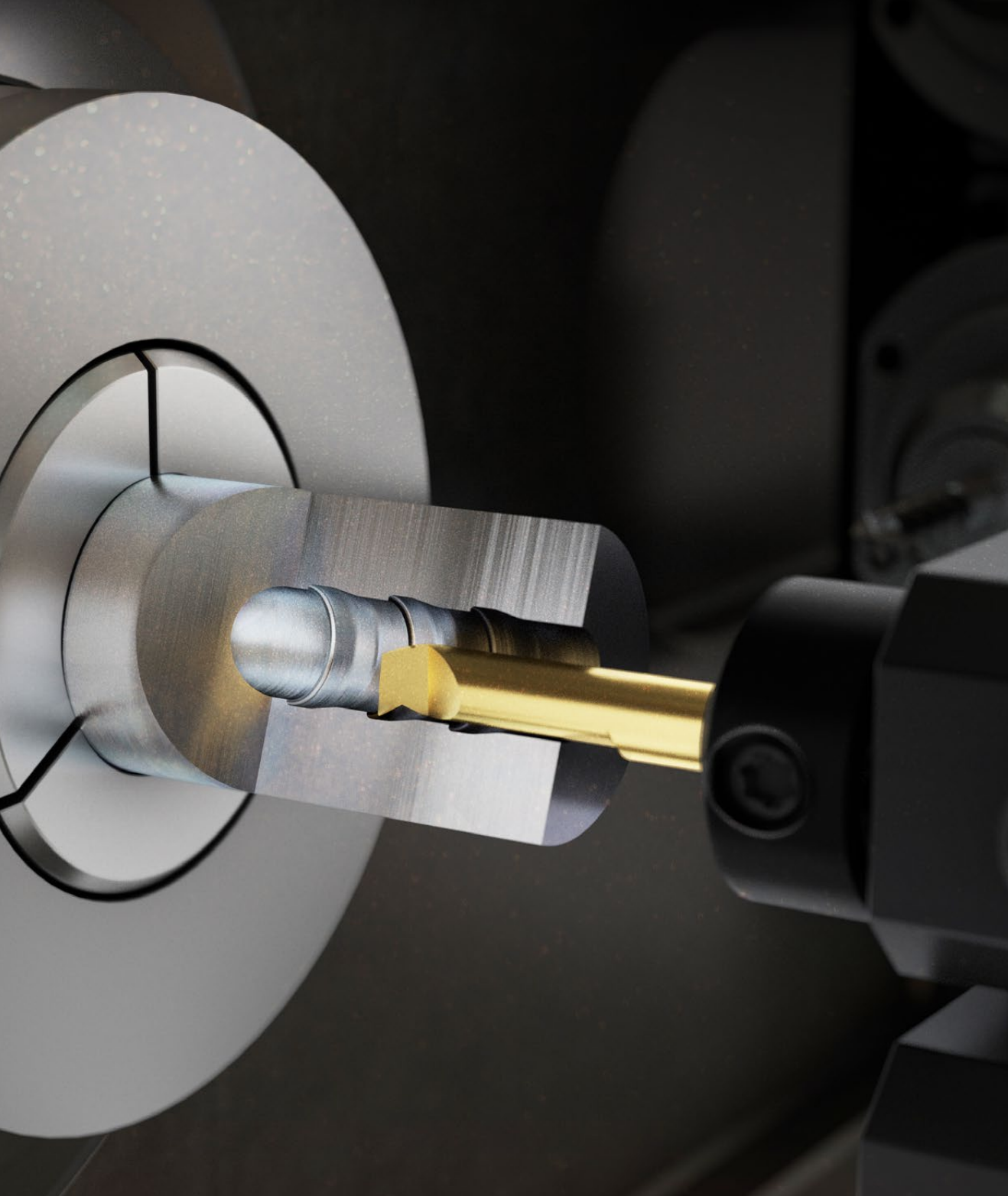

SOLID MINIATURE TURNING for SMALL BORE

NEW

Click this
QR code!!



Scan this QR code
to see our
Nanocut
at work.



Code Keys - Boring bar & Holder

Boring bar

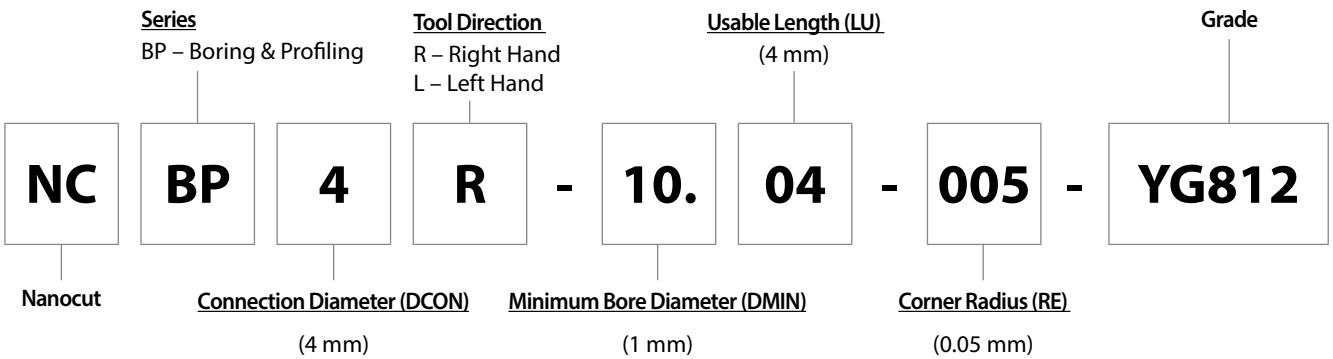

Holder

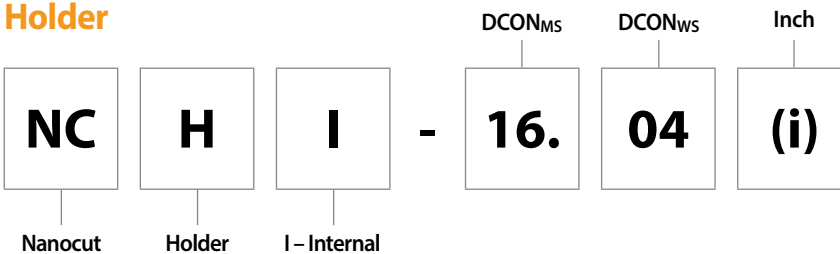

Success Story

Cutting Conditions

Size	Ø 6 mm, R 0.2 mm
Work Material	SCM440 (HRc 20)
Cutting Speed	100 m/min.
RPM	637 rev./min.
Feed per Revolution	0.1 mm/rev.
Boring Depth	Axial: 10 mm Radial: 0.15 mm
Coolant	Wet Cut
Operation	Boring
Machine	Turn Mill



Competitor

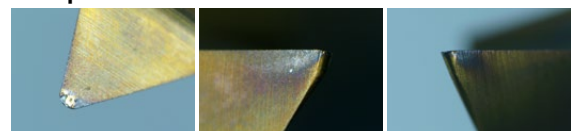

Overview

At present, as demand for small parts (camera lens, mobile phone parts) and medical instruments (implants) increases, demand for small-diameter products capable of high-precision processing is increasing.

Application

- Turning of Small Bore Components
- Internal Turning(Boring), Grooving and Threading



Features

- Minimum Diameter(Boring & Profiling series) : \varnothing 1 mm
- Internal Coolant for Longer Tool life and Enhanced Chip Evacuation
- Secure Connection Design: Pin + Slant Positioning
- 10 Geometries for Various Applications

Benefits

- Reduced Machine Down Time
- Lower Machining Cost

YG812 - Micro Grain Carbide Grade

P10 - P20 **M20 - M30** Submicron Grade Carbide Substrate Material for high toughness
K20 - K30 **S10 - S25** and wear resistance realizes high precision machining

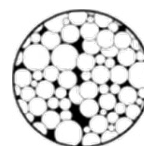

Advantages of Nanocut

Easy Clamping

Secure and Simple system for fast change and fast locking

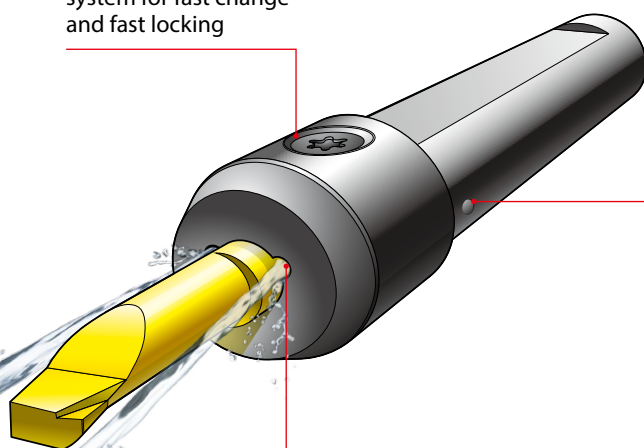

Internal Coolant

Helps chip evacuation and improves tool life

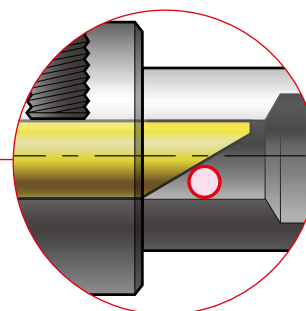

Secure Slant Connection

Ensures High repeatability for height and axial position

Click/Touch each page number and move to the very page!

Overview

Recommended Cutting Conditions : p.223

Series		KAPR (°)	DCON (mm)	Page
BP	Boring & Profiling	98	4,6	132
BO	Boring with Chipbreaker	98		133
BF	90° Boring	90		134
PR	Profiling	98		135
Series		CW (mm)	DCON (mm)	Page
GR	Grooving Round	1.00-2.00	4,6	136
GS	Grooving Square	0.79-2.00		137
FI	Face Grooving Internal	1.00-3.00		138
FE	Face Grooving External	1.00-3.00		138
Series		WF (mm)	DCON (mm)	Page
CH	Chamfering	0.50-1.10	4,6	139
TH	Threading	2.00-2.95		140
Series		DCON _{WS} (mm)	DCON _{MS} (mm)	Page
Holder		4,6	12-25	141

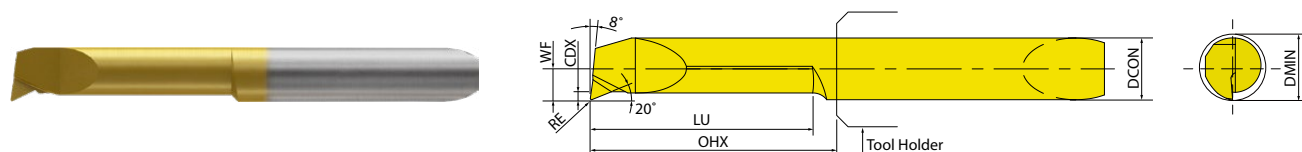

●: Stock item
○: Order made item

KAPR	DCON (mm)	Designation	EDP	Metric (mm)							YG812
				DMIN	LU	RE	CDX	WF	OHX	OAL	
98°	4	NCBP4R-10.04-005-YG812	NCBP04R1004005T	1	4	0.05	0.1	0.45	13	28	●
		NCBP4R-10.04-010-YG812	NCBP04R1004010T	1	4	0.10	0.1	0.45	13	28	●
		NCBP4R-10.06-005-YG812	NCBP04R1006005T	1	6	0.05	0.1	0.45	13	28	●
		NCBP4R-10.06-010-YG812	NCBP04R1006010T	1	6	0.10	0.1	0.45	13	28	●
		NCBP4R-17.06-005-YG812	NCBP04R1706005T	1.7	6	0.05	0.2	0.7	13	28	○
		NCBP4R-17.06-010-YG812	NCBP04R1706010T	1.7	6	0.10	0.2	0.7	13	28	●
		NCBP4R-17.09-005-YG812	NCBP04R1709005T	1.7	9	0.05	0.2	0.7	13	28	○
		NCBP4R-17.09-010-YG812	NCBP04R1709010T	1.7	9	0.10	0.2	0.7	13	28	●
		NCBP4R-22.06-005-YG812	NCBP04R2206005T	2.2	6	0.05	0.2	0.95	13	28	○
		NCBP4R-22.06-010-YG812	NCBP04R2206010T	2.2	6	0.10	0.2	0.95	13	28	●
		NCBP4R-22.09-005-YG812	NCBP04R2209005T	2.2	9	0.05	0.2	0.95	13	28	○
		NCBP4R-22.09-010-YG812	NCBP04R2209010T	2.2	9	0.10	0.2	0.95	13	28	●
		NCBP4R-22.13-010-YG812	NCBP04R2213010T	2.2	13	0.10	0.2	0.95	18	33	●
		NCBP4R-27.10-005-YG812	NCBP04R2710005T	2.7	10	0.05	0.2	1.2	13	28	○
		NCBP4R-27.10-015-YG812	NCBP04R2710015T	2.7	10	0.15	0.2	1.2	13	28	●
		NCBP4R-27.15-005-YG812	NCBP04R2715005T	2.7	15	0.05	0.2	1.2	18	33	○
		NCBP4R-27.15-015-YG812	NCBP04R2715015T	2.7	15	0.15	0.2	1.2	18	33	●
		NCBP4R-32.10-015-YG812	NCBP04R3210015T	3.2	10	0.15	0.2	1.45	13	28	●
		NCBP4R-32.15-015-YG812	NCBP04R3215015T	3.2	15	0.15	0.2	1.45	18	33	●
		NCBP4R-32.20-005-YG812	NCBP04R3220005T	3.2	20	0.05	0.2	1.45	23	38	○
NCBP4R-32.20-015-YG812	NCBP04R3220015T	3.2	20	0.15	0.2	1.45	23	38	●		
NCBP4R-42.10-015-YG812	NCBP04R4210015T	4.2	10	0.15	0.3	1.95	13	28	●		
NCBP4R-42.15-005-YG812	NCBP04R4215005T	4.2	15	0.05	0.3	1.95	18	33	○		
NCBP4R-42.15-015-YG812	NCBP04R4215015T	4.2	15	0.15	0.3	1.95	18	33	●		
NCBP4R-42.20-005-YG812	NCBP04R4220005T	4.2	20	0.05	0.3	1.95	23	38	○		
NCBP4R-42.20-015-YG812	NCBP04R4220015T	4.2	20	0.15	0.3	1.95	23	38	●		
NCBP4R-42.25-005-YG812	NCBP04R4225005T	4.2	25	0.05	0.3	1.95	28	43	○		
NCBP4R-42.25-015-YG812	NCBP04R4225015T	4.2	25	0.15	0.3	1.95	28	43	●		
6	NCBP6R-62.15-020-YG812	NCBP06R6215020T	6.2	15	0.20	0.5	2.95	20.5	43	●	
	NCBP6R-62.20-020-YG812	NCBP06R6220020T	6.2	20	0.20	0.5	2.95	25.5	48	●	
	NCBP6R-62.25-020-YG812	NCBP06R6225020T	6.2	25	0.20	0.5	2.95	30.5	53	●	
	NCBP6R-62.30-020-YG812	NCBP06R6230020T	6.2	30	0.20	0.5	2.95	35.5	58	●	
	NCBP6R-62.35-020-YG812	NCBP06R6235020T	6.2	35	0.20	0.5	2.95	40.5	63	●	
	NCBP6R-62.40-020-YG812	NCBP06R6240020T	6.2	40	0.20	0.5	2.95	45.5	68	●	

Boring bar - Inserts

BO - Boring with Chip Breaker

NEW

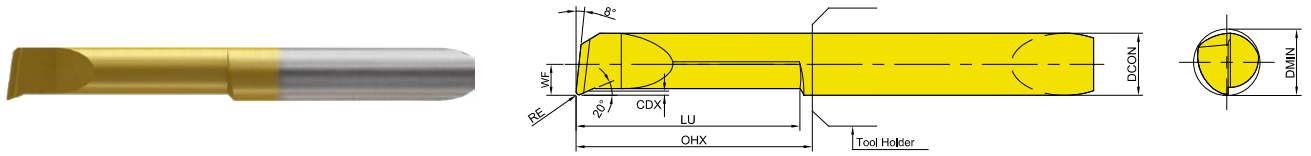

●: Stock item
○: Order made item

KAPR	DCON (mm)	Designation	EDP	Metric (mm)							YG812
				DMIN	LU	RE	CDX	WF	OHX	OAL	
98°	4	NCBO4R - 10.06 - 005 - YG812	NCBO04R1006005T	1	6	0.05	0.1	0.45	13	28	○
		NCBO4R - 10.06 - 010 - YG812	NCBO04R1006010T	1	6	0.10	0.1	0.45	13	28	●
		NCBO4R - 17.09 - 005 - YG812	NCBO04R1709005T	1.7	9	0.05	0.2	0.7	13	28	○
		NCBO4R - 17.09 - 010 - YG812	NCBO04R1709010T	1.7	9	0.10	0.2	0.7	13	28	○
		NCBO4R - 22.09 - 005 - YG812	NCBO04R2209005T	2.2	9	0.05	0.2	0.95	13	28	○
		NCBO4R - 22.09 - 010 - YG812	NCBO04R2209010T	2.2	9	0.10	0.2	0.95	13	28	●
		NCBO4R - 22.13 - 010 - YG812	NCBO04R2213010T	2.2	13	0.10	0.2	0.95	18	33	○
		NCBO4R - 27.15 - 005 - YG812	NCBO04R2715005T	2.7	15	0.05	0.2	1.2	18	33	○
		NCBO4R - 27.15 - 015 - YG812	NCBO04R2715015T	2.7	15	0.15	0.2	1.2	18	33	○
		NCBO4R - 32.15 - 015 - YG812	NCBO04R3215015T	3.2	15	0.15	0.2	1.45	18	33	●
		NCBO4R - 32.20 - 005 - YG812	NCBO04R3220005T	3.2	20	0.05	0.2	1.45	23	38	○
		NCBO4R - 32.20 - 015 - YG812	NCBO04R3220015T	3.2	20	0.15	0.2	1.45	23	38	●
		NCBO4R - 42.20 - 005 - YG812	NCBO04R4220005T	4.2	20	0.05	0.3	1.95	23	38	○
		NCBO4R - 42.20 - 015 - YG812	NCBO04R4220015T	4.2	20	0.15	0.3	1.95	23	38	●
		NCBO4R - 42.25 - 005 - YG812	NCBO04R4225005T	4.2	25	0.05	0.3	1.95	28	43	○
NCBO4R - 42.25 - 015 - YG812	NCBO04R4225015T	4.2	25	0.15	0.3	1.95	28	43	●		
6	6	NCBO6R - 62.15 - 020 - YG812	NCBO06R6215020T	6.2	15	0.20	0.5	2.95	20.5	43	●
		NCBO6R - 62.25 - 020 - YG812	NCBO06R6225020T	6.2	25	0.20	0.5	2.95	30.5	53	●
		NCBO6R - 62.30 - 020 - YG812	NCBO06R6230020T	6.2	30	0.20	0.5	2.95	35.5	58	●
		NCBO6R - 62.35 - 020 - YG812	NCBO06R6235020T	6.2	35	0.20	0.5	2.95	40.5	63	●
		NCBO6R - 62.40 - 020 - YG812	NCBO06R6240020T	6.2	40	0.20	0.5	2.95	45.5	68	○

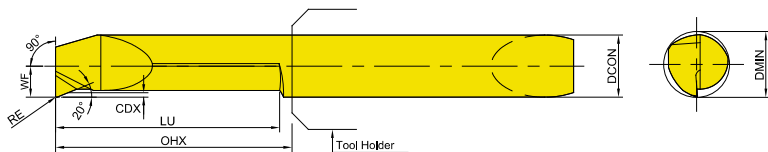

●: Stock item
○: Order made item

KAPR	DCON (mm)	Designation	EDP	Metric (mm)							YG812	
				DMIN	LU	RE	CDX	WF	OHX	OAL		
90°	4	NCBF4R-10.04-010-YG812	NCBF04R1004010T	1	4	0.10	0.1	0.45	13	28	○	
		NCBF4R-10.06-010-YG812	NCBF04R1006010T	1	6	0.10	0.1	0.45	13	28	○	
		NCBF4R-17.06-010-YG812	NCBF04R1706010T	1.7	6	0.10	0.2	0.7	13	28	○	
		NCBF4R-17.09-010-YG812	NCBF04R1709010T	1.7	9	0.10	0.2	0.7	13	28	○	
		NCBF4R-22.06-010-YG812	NCBF04R2206010T	2.2	6	0.10	0.2	0.95	13	28	○	
		NCBF4R-22.09-010-YG812	NCBF04R2209010T	2.2	9	0.10	0.2	0.95	13	28	○	
		NCBF4R-22.13-010-YG812	NCBF04R2213010T	2.2	13	0.10	0.2	0.95	18	33	○	
		NCBF4R-27.10-015-YG812	NCBF04R2710015T	2.7	10	0.15	0.2	1.2	13	28	○	
		NCBF4R-27.15-015-YG812	NCBF04R2715015T	2.7	15	0.15	0.2	1.2	18	33	○	
		NCBF4R-32.10-015-YG812	NCBF04R3210015T	3.2	10	0.15	0.2	1.45	13	28	○	
		NCBF4R-32.15-015-YG812	NCBF04R3215015T	3.2	15	0.15	0.2	1.45	18	33	○	
		NCBF4R-32.20-015-YG812	NCBF04R3220015T	3.2	20	0.15	0.2	1.45	23	38	○	
		NCBF4R-42.10-015-YG812	NCBF04R4210015T	4.2	10	0.15	0.3	1.95	13	28	○	
		NCBF4R-42.15-015-YG812	NCBF04R4215015T	4.2	15	0.15	0.3	1.95	18	33	○	
		NCBF4R-42.20-015-YG812	NCBF04R4220015T	4.2	20	0.15	0.3	1.95	23	38	○	
		NCBF4R-42.25-015-YG812	NCBF04R4225015T	4.2	25	0.15	0.3	1.95	28	43	○	
		6	NCBF6R-62.15-020-YG812	NCBF06R6215020T	6.2	15	0.20	0.5	2.95	20.5	43	○
			NCBF6R-62.20-020-YG812	NCBF06R6220020T	6.2	20	0.20	0.5	2.95	25.5	48	○
NCBF6R-62.25-020-YG812	NCBF06R6225020T		6.2	25	0.20	0.5	2.95	30.5	53	○		
NCBF6R-62.30-020-YG812	NCBF06R6230020T		6.2	30	0.20	0.5	2.95	35.5	58	○		
NCBF6R-62.35-020-YG812	NCBF06R6235020T		6.2	35	0.20	0.5	2.95	40.5	63	○		
NCBF6R-62.40-020-YG812	NCBF06R6240020T		6.2	40	0.20	0.5	2.95	45.5	68	○		

Boring bar - Inserts **NEW**
PR - Profiling

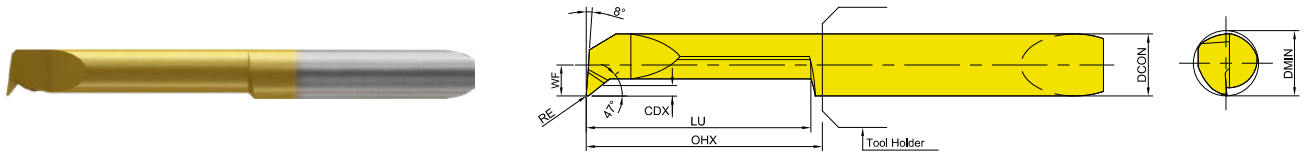

●: Stock item
 ○: Order made item

KAPR	DCON (mm)	Designation	EDP	Metric (mm)							YG812
				DMIN	LU	RE	CDX	WF	OHX	OAL	
98°	4	NCPR4R-10.04-010-YG812	NCPR04R1004010T	1	4	0.10	0.1	0.45	13	28	○
		NCPR4R-10.06-010-YG812	NCPR04R1006010T	1	6	0.10	0.1	0.45	13	28	○
		NCPR4R-17.06-010-YG812	NCPR04R1706010T	1.7	6	0.10	0.2	0.7	13	28	○
		NCPR4R-17.09-010-YG812	NCPR04R1709010T	1.7	9	0.10	0.2	0.7	13	28	○
		NCPR4R-22.06-010-YG812	NCPR04R2206010T	2.2	6	0.10	0.2	0.95	13	28	○
		NCPR4R-22.09-010-YG812	NCPR04R2209010T	2.2	9	0.10	0.2	0.95	13	28	○
		NCPR4R-22.13-010-YG812	NCPR04R2213010T	2.2	13	0.10	0.2	0.95	18	33	○
		NCPR4R-27.10-015-YG812	NCPR04R2710015T	2.7	10	0.15	0.2	1.2	13	28	○
	NCPR4R-27.15-015-YG812	NCPR04R2715015T	2.7	15	0.15	0.2	1.2	18	33	○	
	NCPR4R-32.10-015-YG812	NCPR04R3210015T	3.2	10	0.15	0.2	1.45	13	28	○	
	NCPR4R-32.15-015-YG812	NCPR04R3215015T	3.2	15	0.15	0.2	1.45	18	33	○	
	NCPR4R-32.20-015-YG812	NCPR04R3220015T	3.2	20	0.15	0.2	1.45	23	38	○	
	NCPR4R-42.10-015-YG812	NCPR04R4210015T	4.2	10	0.15	0.3	1.95	13	28	●	
	NCPR4R-42.15-015-YG812	NCPR04R4215015T	4.2	15	0.15	0.3	1.95	18	33	●	
	NCPR4R-42.20-015-YG812	NCPR04R4220015T	4.2	20	0.15	0.3	1.95	23	38	●	
	NCPR4R-42.25-015-YG812	NCPR04R4225015T	4.2	25	0.15	0.3	1.95	28	43	○	
6	NCPR6R-62.15-020-YG812	NCPR06R6215020T	6.2	15	0.20	0.5	2.95	20.5	43	●	
	NCPR6R-62.20-020-YG812	NCPR06R6220020T	6.2	20	0.20	0.5	2.95	25.5	48	●	
	NCPR6R-62.25-020-YG812	NCPR06R6225020T	6.2	25	0.20	0.5	2.95	30.5	53	○	
	NCPR6R-62.30-015-YG812	NCPR06R6230015T	6.2	30	0.15	0.5	2.95	35.5	58	●	
	NCPR6R-62.30-020-YG812	NCPR06R6230020T	6.2	30	0.20	0.5	2.95	35.5	58	○	
	NCPR6R-62.35-020-YG812	NCPR06R6235020T	6.2	35	0.20	0.5	2.95	40.5	63	○	
	NCPR6R-62.40-020-YG812	NCPR06R6240020T	6.2	40	0.20	0.5	2.95	45.5	68	○	

Boring bar - Inserts

GR - Grooving Round NEW

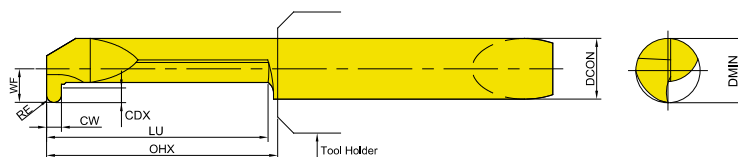

●: Stock item
 ○: Order made item

DCON (mm)	Designation	EDP	Metric (mm)									YG812
			DMIN	LU	RE	CW	CDX	WF	OHX	OAL		
4	NCGR4R - 42.15 - 10x08 - YG812	NCGR04R4215100T	4.2	15	0.5	1.0	0.8	1.95	18	33	○	
	NCGR4R - 42.15 - 12x08 - YG812	NCGR04R4215120T	4.2	15	0.58	1.2	0.8	1.95	18	33	○	
	NCGR4R - 42.15 - 15x08 - YG812	NCGR04R4215150T	4.2	15	0.75	1.5	1	1.95	18	33	○	
	NCGR4R - 42.15 - 16x08 - YG812	NCGR04R4215160T	4.2	15	0.81	1.6	1	1.95	18	33	○	
6	NCGR6R - 62.25 - 10x18 - YG812	NCGR06R6225100T	6.2	25	0.5	1.0	1.8	2.95	30.5	53	○	
	NCGR6R - 62.25 - 15x18 - YG812	NCGR06R6225150T	6.2	25	0.75	1.5	1.8	2.95	30.5	53	○	
	NCGR6R - 62.25 - 16x18 - YG812	NCGR06R6225160T	6.2	25	0.81	1.6	1.8	2.95	30.5	53	○	
	NCGR6R - 62.25 - 20x18 - YG812	NCGR06R6225200T	6.2	25	1	2.0	1.8	2.95	30.5	53	○	

TURNING

PARTING & GROOVING

MILLING

DRILLING

TECHNICAL INFORMATION

Boring bar - Inserts

GS - Grooving Square

NEW

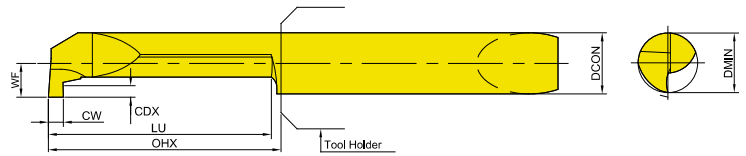

●: Stock item
○: Order made item

DCON (mm)	Designation	EDP	Metric (mm)							YG812
			DMIN	LU	CW	CDX	WF	OHX	OAL	
4	NCGS4R - 42.10 - 079x08 - YG812	NCGS04R4210079T	4.2	10	0.79	0.8	1.95	13	38	○
	NCGS4R - 42.15 - 079x08 - YG812	NCGS04R4215079T	4.2	15	0.79	0.8	1.95	18	43	○
	NCGS4R - 42.20 - 079x08 - YG812	NCGS04R4220079T	4.2	20	0.79	0.8	1.95	23	48	○
	NCGS4R - 42.10 - 100x08 - YG812	NCGS04R4210100T	4.2	10	1.00	0.8	1.95	13	38	●
	NCGS4R - 42.15 - 100x08 - YG812	NCGS04R4215100T	4.2	15	1.00	0.8	1.95	18	43	●
	NCGS4R - 42.20 - 100x08 - YG812	NCGS04R4220100T	4.2	20	1.00	0.8	1.95	23	48	○
6	NCGS6R - 62.10 - 079x18 - YG812	NCGS06R6210079T	6.2	10	0.79	1.8	2.95	15.5	38	○
	NCGS6R - 62.15 - 079x18 - YG812	NCGS06R6215079T	6.2	15	0.79	1.8	2.95	20.5	43	○
	NCGS6R - 62.25 - 079x18 - YG812	NCGS06R6225079T	6.2	25	0.79	1.8	2.95	30.5	53	○
	NCGS6R - 62.35 - 079x18 - YG812	NCGS06R6235079T	6.2	35	0.79	1.8	2.95	40.5	63	○
	NCGS6R - 62.10 - 100x18 - YG812	NCGS06R6210100T	6.2	10	1.00	1.8	2.95	15.5	38	○
	NCGS6R - 62.15 - 100x18 - YG812	NCGS06R6215100T	6.2	15	1.00	1.8	2.95	20.5	43	●
	NCGS6R - 62.25 - 100x18 - YG812	NCGS06R6225100T	6.2	25	1.00	1.8	2.95	30.5	53	●
	NCGS6R - 62.35 - 100x18 - YG812	NCGS06R6235100T	6.2	35	1.00	1.8	2.95	40.5	63	○
	NCGS6R - 62.10 - 117x18 - YG812	NCGS06R6210117T	6.2	10	1.17	1.8	2.95	15.5	38	○
	NCGS6R - 62.15 - 117x18 - YG812	NCGS06R6215117T	6.2	15	1.17	1.8	2.95	20.5	43	○
	NCGS6R - 62.25 - 117x18 - YG812	NCGS06R6225117T	6.2	25	1.17	1.8	2.95	30.5	53	○
	NCGS6R - 62.35 - 117x18 - YG812	NCGS06R6235117T	6.2	35	1.17	1.8	2.95	40.5	63	○
	NCGS6R - 62.10 - 150x18 - YG812	NCGS06R6210150T	6.2	10	1.50	1.8	2.95	15.5	38	●
	NCGS6R - 62.15 - 150x18 - YG812	NCGS06R6215150T	6.2	15	1.50	1.8	2.95	20.5	43	●
	NCGS6R - 62.25 - 150x18 - YG812	NCGS06R6225150T	6.2	25	1.50	1.8	2.95	30.5	53	●
	NCGS6R - 62.35 - 150x18 - YG812	NCGS06R6235150T	6.2	35	1.50	1.8	2.95	40.5	63	○
	NCGS6R - 62.10 - 157x18 - YG812	NCGS06R6210157T	6.2	10	1.57	1.8	2.95	15.5	38	○
	NCGS6R - 62.15 - 157x18 - YG812	NCGS06R6215157T	6.2	15	1.57	1.8	2.95	20.5	43	○
	NCGS6R - 62.25 - 157x18 - YG812	NCGS06R6225157T	6.2	25	1.57	1.8	2.95	30.5	53	○
	NCGS6R - 62.35 - 157x18 - YG812	NCGS06R6235157T	6.2	35	1.57	1.8	2.95	40.5	63	○
	NCGS6R - 62.10 - 198x18 - YG812	NCGS06R6210198T	6.2	10	1.98	1.8	2.95	15.5	38	○
	NCGS6R - 62.15 - 198x18 - YG812	NCGS06R6215198T	6.2	15	1.98	1.8	2.95	20.5	43	○
	NCGS6R - 62.25 - 198x18 - YG812	NCGS06R6225198T	6.2	25	1.98	1.8	2.95	30.5	53	○
	NCGS6R - 62.30 - 198x18 - YG812	NCGS06R6230198T	6.2	30	1.98	1.8	2.95	35.5	58	○
NCGS6R - 62.10 - 200x18 - YG812	NCGS06R6210200T	6.2	10	2.00	1.8	2.95	15.5	38	●	
NCGS6R - 62.15 - 200x18 - YG812	NCGS06R6215200T	6.2	15	2.00	1.8	2.95	20.5	43	●	
NCGS6R - 62.25 - 200x18 - YG812	NCGS06R6225200T	6.2	25	2.00	1.8	2.95	30.5	53	●	

Boring bar - Inserts

FI - Face Grooving Internal

NEW

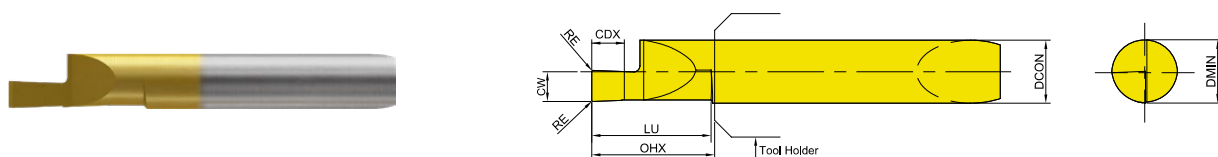

●: Stock item
○: Order made item

DCON (mm)	Designation	EDP	Metric (mm)									YG812
			DMIN	LU	RE	CW	CDX	WF	OHX	OAL		
6	NCFI6R - 62.15 - 10x20 - YG812	NCFI06R6215010T	6.2	15	0.1	1.0	2.0	2.95	20.5	43	●	
	NCFI6R - 62.15 - 15x30 - YG812	NCFI06R6215015T	6.2	15	0.1	1.5	3.0	2.95	20.5	43	●	
	NCFI6R - 62.15 - 20x40 - YG812	NCFI06R6215020T	6.2	15	0.1	2.0	4.0	2.95	20.5	43	●	
	NCFI6R - 62.15 - 25x50 - YG812	NCFI06R6215025T	6.2	15	0.1	2.5	5.0	2.95	20.5	43	●	
	NCFI6R - 62.15 - 30x60 - YG812	NCFI06R6215030T	6.2	15	0.1	3.0	6.0	2.95	20.5	43	●	

TURNING

PARTING & GROOVING

MILLING

DRILLING

TECHNICAL INFORMATION

Boring bar - Inserts

FE - Face Grooving External

NEW

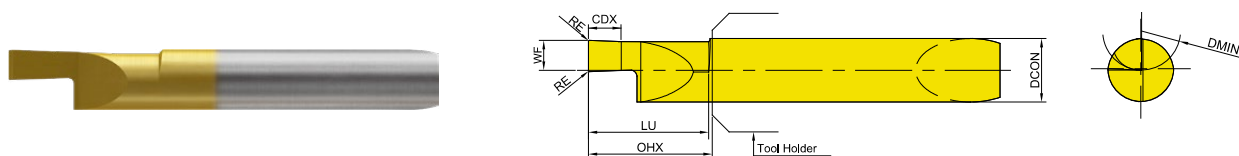

●: Stock item
○: Order made item

DCON (mm)	Designation	EDP	Metric (mm)									YG812
			DMIN	LU	RE	CW	CDX	WF	OHX	OAL		
6	NCFE6R - 62.15 - 10x20 - YG812	NCFE06R6215010T	6.2	15	0.1	1.0	2.0	2.95	20.5	43	●	
	NCFE6R - 62.15 - 15x30 - YG812	NCFE06R6215015T	6.2	15	0.1	1.5	3.0	2.95	20.5	43	●	
	NCFE6R - 62.15 - 20x40 - YG812	NCFE06R6215020T	6.2	15	0.1	2.0	4.0	2.95	20.5	43	●	
	NCFE6R - 62.15 - 25x50 - YG812	NCFE06R6215025T	6.2	15	0.1	2.5	5.0	2.95	20.5	43	●	
	NCFE6R - 62.15 - 30x60 - YG812	NCFE06R6215030T	6.2	15	0.1	3.0	6.0	2.95	20.5	43	●	

Boring bar - Inserts
CH - Chamfering NEW

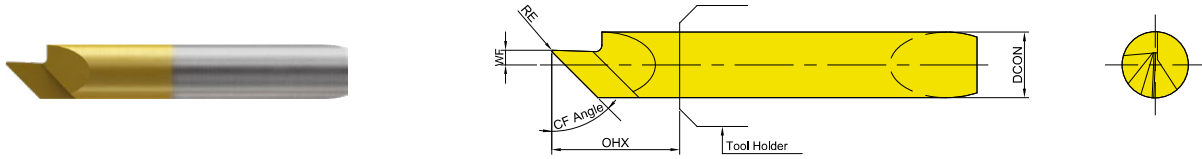

●: Stock item
 ○: Order made item

KAPR	DCON (mm)	Designation	EDP	Metric (mm)						YG812
				DMIN	RE	CDX	WF	OHX	OAL	
45°	6	NCCH6R - 10.03 - 45 - YG812	NCCH06R103045T	1.0	0.2	3.5	1.1	15.5	38	○
60°		NCCH6R - 10.04 - 60 - YG812	NCCH06R103060T	1.0	0.2	4	0.5	15.5	38	○

TURNING
PARTING & GROOVING
MILLING
DRILLING
TECHNICAL INFORMATION

TURNING

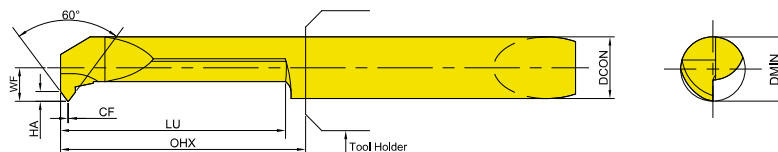

PARTING & GROOVING

* P-60 : Partial Profile, 60°

DCON (mm)	Designation	EDP	Metric (mm)										YG812
			DMIN	LU	TPN	TPX	WF	HA	CF	OHX	OAL		
4	NCTH04R - 42.15 - 050 - P - 60 - YG812	NCTV04R4215050T	4.2	15	0.50	0.70	2	0.45	0.06	18	33	○	
	NCTH04R - 42.15 - 075 - P - 60 - YG812	NCTV04R4215075T	4.2	15	0.75	1.00	2.35	0.65	0.09	18	33	○	
	NCTH04R - 42.15 - 100 - P - 60 - YG812	NCTV04R4215100T	4.2	15	1.00	1.25	2.25	0.8	0.12	18	33	○	
6	NCTH06R - 62.15 - 100 - P - 60 - YG812	NCTV06R6215100T	6.2	15	1.00	1.25	2.95	0.8	0.12	20.5	43	○	
	NCTH06R - 62.15 - 125 - P - 60 - YG812	NCTV06R6215125T	6.2	15	1.25	1.50	2.3	0.97	0.15	20.5	43	○	
	NCTH06R - 62.15 - 150 - P - 60 - YG812	NCTV06R6215150T	6.2	15	1.50	1.75	2.95	1.14	0.18	20.5	43	○	

MILLING

DRILLING

TECHNICAL INFORMATION

Boring bar - Holder
Holder NEW

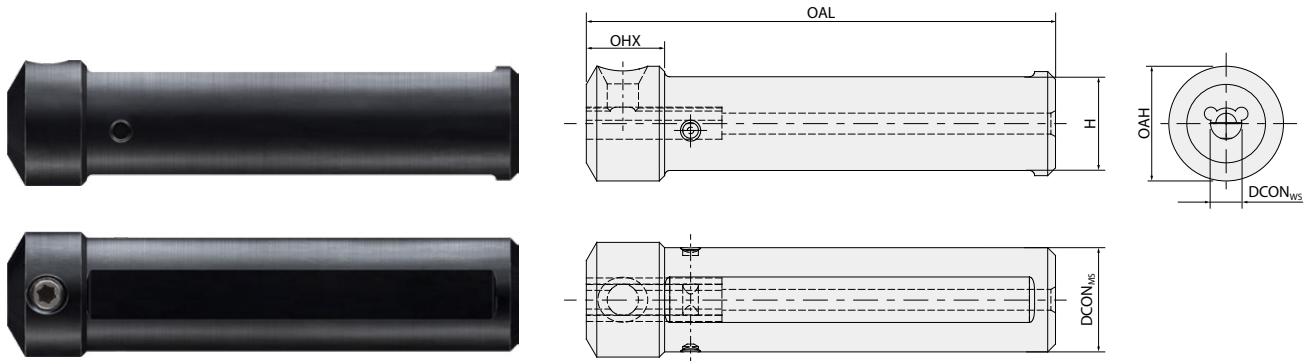

Scale	Insert Size (DCON _{MS})	Designation	EDP	DCON _{MS}	OAL	H	OAH	OHX
Metric (mm)	4	NCHI - 12.4	ZBR0400012	12	70	10	15.5	14
		NCHI - 16.4	ZBR0400016	16	75	14	17.5	
		NCHI - 20.4	ZBR0400020	20	90	18	20	
		NCHI - 22.4	ZBR0400022	22	110	20	22	
		NCHI - 25.4	ZBR0400025	25	110	23	25	
	6	NCHI - 12.6	ZBR0600012	12	70	10	16.5	
		NCHI - 16.6	ZBR0600016	16	75	14	18.5	
		NCHI - 20.6	ZBR0600020	20	90	18	22	
		NCHI - 22.6	ZBR0600022	22	110	20	22	
		NCHI - 25.6	ZBR0600025	25	110	23	25	

TURNING
PARTING & GROOVING
MILLING
DRILLING
TECHNICAL INFORMATION

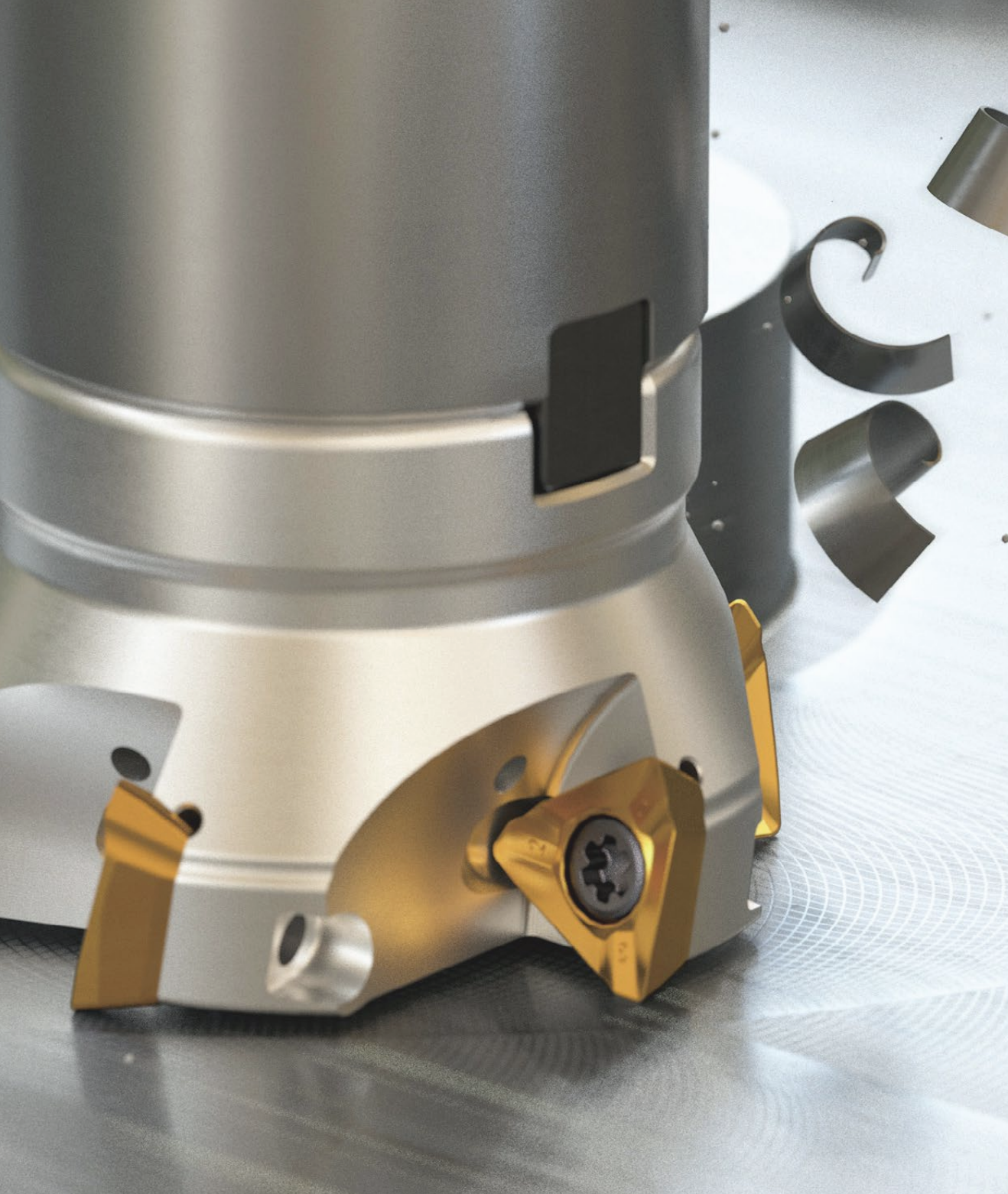

MILLING

Product Overview

Application Guide

Milling Inserts & Cutter Overview

Milling Inserts & Cutter



Scan this QR code
to see our
YG FM10 Mill
at work.



Scan this QR code
to see our
YG HF4 Mill
at work.

Code Keys - Milling Cutters

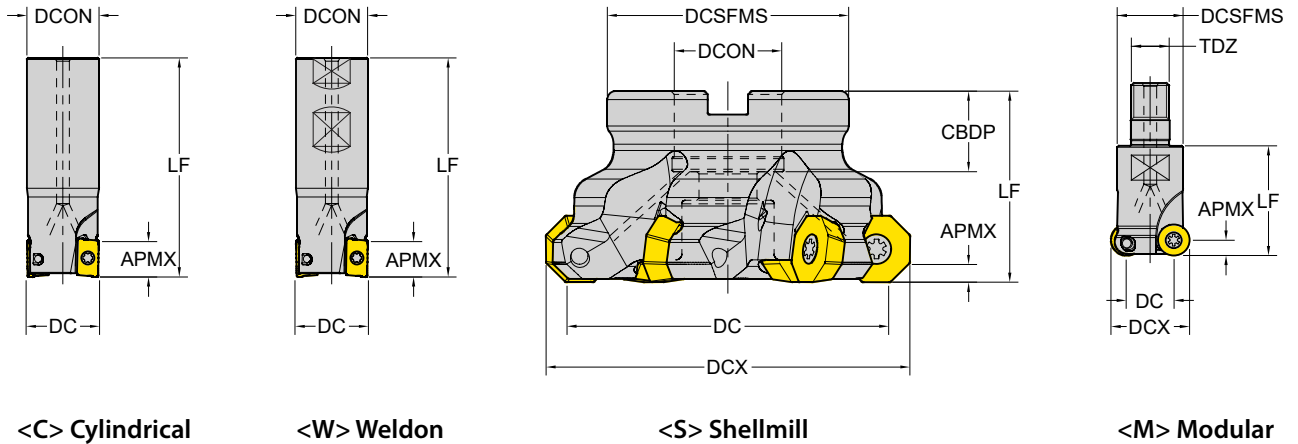

Cutting tool edge angle
(90°)

Cutter Diameter
(Ø16)

Connection Type and Size
C - Cylindrical W - Weldon
S - Shellmill M - Modular
(Cylindrical Ø16)

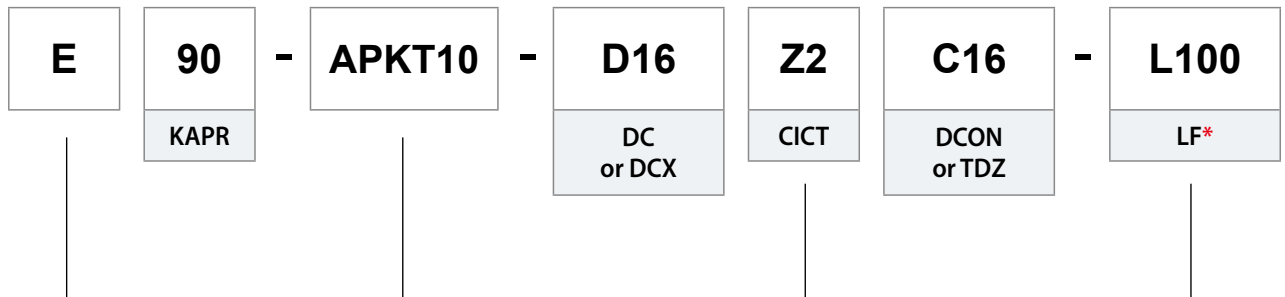

Cutter Type
E - Endmill Type
F - Facemill Type
M - Modular Type

Insert Series
(APKT 10)

Number of Teeth
(Z=2)

Functional Length
(100mm)

Milling - Code System
Insert ISO Code System

TURNING

PARTING & GROOVING









MILLING

DRILLING

TECHNICAL INFORMATION

1 A Shape	2 P Relief Angle (AN)	3 K Tolerance	4 T Clamping & Chipbreaker	5 16 Insert Size	6 04 Insert Thickness (S)	7 08 Corner Radius
-------------------------------	---	-----------------------------------	--	--------------------------------------	---	--

1 - Shape

Symbol	Shape	
H	Hexagonal	
O	Octagonal	
P	Pentagonal	
S	Square	
T	Triangular	
W	Trigon	
L	Rectangular	
A	Parallelogram 80°	
R	Round	

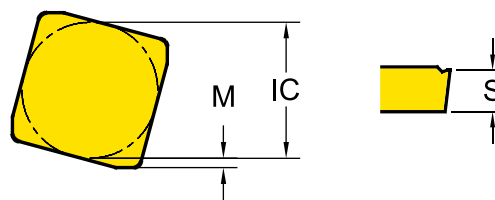





3 - Tolerance Class

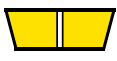

Symbol	Inner Circle IC (mm)	Nose Height M (mm)	Thickness S (mm)
C	± 0.025	± 0.013	± 0.025
E	± 0.025	± 0.025	± 0.025
G	± 0.025	± 0.025	± 0.13
H	± 0.013	± 0.013	± 0.025
K*	± 0.05~0.15*	± 0.013	± 0.025
M*	± 0.05~0.15*	± 0.08~0.2*	± 0.13
U*	± 0.08~0.25*	± 0.13~0.38*	± 0.13

* Tolerance is different by insert IC size. Please see ISO 1832

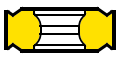
4 - Clamping & Chipbreaker

Symbol	Clamping	Chipbreaker	Figure
N	No clamping hole	X	
R		One Face	
W	Screw Hole	X	
T		One Face	
U		Both Faces	
X		Special	

2 - Relief Angle (AN)

Symbol	Relief Angle (AN)	
N	No Relief Angle	
B	Relief 5°	
C	Relief 7°	
P	Relief 11°	
D	Relief 15°	
E	Relief 20°	
F	Relief 25°	
O	Special	

5 - Insert Size

* No Standard for milling insert size

6 - Insert Thickness

* No Standard for milling insert thickness

Milling - Code System

Insert ISO Code System

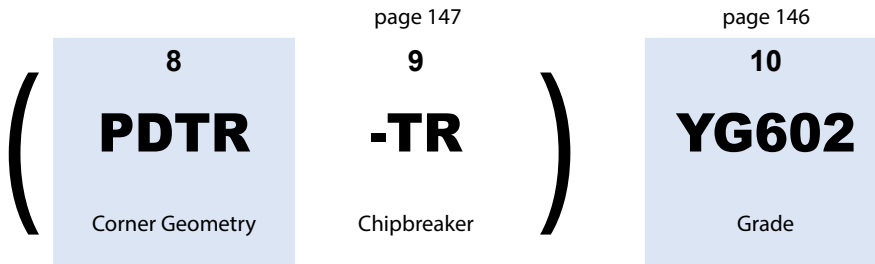

7 - Corner Radius (RE)

Symbol	Corner Radius - RE(mm)	Symbol	Corner Radius - RE(mm)
04	0.4	16	1.6
08	0.8	20	2.0
12	1.2	24	2.4

8 - Corner Geometry

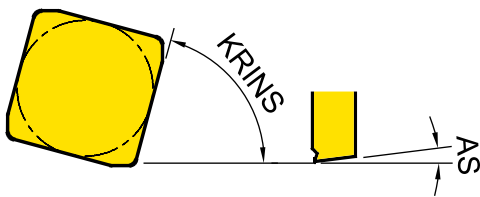

8-1	8-2	8-3	8-4
P	D	T	R
Cutting Edge Angle (KRINS)	Wiper Edge Clearance (AS)	Edge Condition	Feed Direction

*Refer to page. 147 for -AL, -ST, -TR... types

8-1 - Cutting Edge Angle (KRINS)

Symbol	Cutting Edge Angle (KRINS)
P	90°
A	45°
D	60°
E	75°
F	85°
Z	Special

8-3 - Edge Condition

Symbol	Edge Condition
F	Sharp
E	Round
T	Chamfer
S	Chamfer and Round

8-2 - Wiper Edge Clearance (AS)

Symbol	Wiper Edge Clearance (AS)
N	0°
P	11°
D	15°
E	20°
F	25°
Z	Special

8-4 - Feed Direction

Symbol	Feed Direction
R	Right-hand Insert
N	Neutral Insert
L	Left-hand Insert

Milling Grades and Chipbreakers

Milling Grades

Milling Grades	P Steel					M Stainless steel				K Cast iron				N Non-ferrous				S Super alloys				H Hardened Steel			
	P05	P15	P25	P35	P45	M05	M15	M25	M35	K05	K15	K25	K35	N05	N15	N25	N35	S05	S15	S25	S35	H05	H15	H25	H35
PVD	YG012	012																	012						
	YG712	712																							
	YG713	713																							
	YG612	612					612												612						
	YG622	622									622														
	YG602	602					602				602								602						
	YG613	613					613																		
	YG501										501														
CVD	YG5020										5020														
Uncoated	YG50														50										

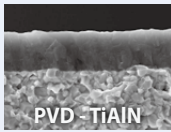
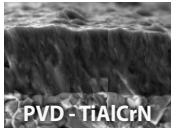
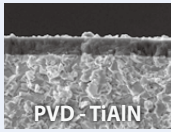
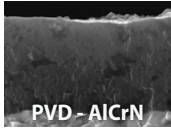
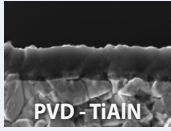

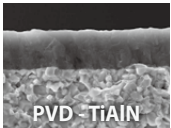
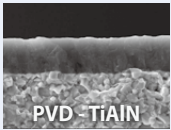
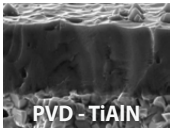
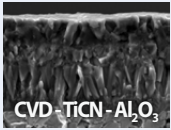
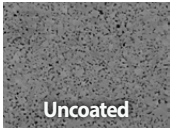

<p>NEW</p> <p>YG012</p> <p>H10 - H30</p> <p>P10 - P30</p>	 <p>PVD - TiAlN</p>	<p>Optimized Milling Grade for Pre-Hardened & Hardened steel</p> <ul style="list-style-type: none"> Applied Extreme Oxidation PVD layer and Crack-free Substrate Excellent Cutting performance for Die & Mold application
<p>YG712</p> <p>P10 - P30</p>	 <p>PVD - TiAlCrN</p>	<p>Milling Grade for Medium of Steel Application</p> <ul style="list-style-type: none"> Superior wear resistance and excellent toughness in high speed machining Coating layer with high hardness and oxidation resistance
<p>YG713</p> <p>P15 - P25</p>	 <p>PVD - TiAlN</p>	<p>Milling Grade for General Steel Application</p> <ul style="list-style-type: none"> Multi-layer TiAlN structure realizes stronger crater and flank wear resistance Fine-grained carbide and balanced substrate
<p>YG622</p> <p>P20 - P35</p> <p>K20 - K40</p>	 <p>PVD - AlCrN</p>	<p>Optimized Grade for High Alloyed or Prehardened Steel</p> <p>Excellent for High Temperature Hardness and Oxidation Resistance at High Speed</p>
<p>NEW</p> <p>YG612</p> <p>P20 - P40</p> <p>M20 - M40</p> <p>S20 - S40</p>	 <p>PVD - TiAlN</p>	<p>Specialized Multi-Nano Coated Grade with high wear resistance and chipping resistance</p> <ul style="list-style-type: none"> Special Multi-Nano coating prevent crack and providing predictable tool life Special universal Grade can achieve stable tool life in any workpiece

Milling Grades and Chipbreakers

Milling Grades

<p>YG602</p> <p>P20 - P35 M20 - M40</p> <p>K20 - K40 S15 - S25</p>	 <p>PVD - TiAlN</p>	<p>Universal grade for General Milling Application</p> <ul style="list-style-type: none"> • Ultra Dense PVD Coating with optimal thermal resistance & strength • Sub-Micron substrate designed for demanding application
<p>YG613</p> <p>P30 - P50</p> <p>M30 - M40</p>	 <p>PVD - TiAlN</p>	<p>Milling Grade for Stainless Steel Application</p> <ul style="list-style-type: none"> • New coating layer with lubrication preventing built-up edge on ultra fine grain substrate with high toughness. • The toughest substrate provides excellent cutting performance in stainless steel
<p>YG501</p> <p>K05 - K25</p>	 <p>PVD - TiAlN</p>	<p>Hard Milling grade for Cast Iron</p> <ul style="list-style-type: none"> • Substrate especially designed for high wear resistance • Excellent wear resistance in cast iron milling application
<p>YG5020</p> <p>K01 - K30</p>	 <p>CVD - TiCN - Al₂O₃</p>	<p>CVD Milling grade for Cast Iron</p> <ul style="list-style-type: none"> • CVD coating for Excellent wear resistance • Improved Toughness for chipping resistance
<p>YG50</p> <p>N05 - N20</p>	 <p>Uncoated</p>	<p>Uncoated Milling Grade for Aluminium</p> <ul style="list-style-type: none"> • Submicron carbide substrate for high wear resistance • Preventing built up edge with shining surface













Milling Chipbreakers

<p>-AL</p>		<ul style="list-style-type: none"> • For Aluminum • Very Sharp Geometry
<p>-ST</p>		<ul style="list-style-type: none"> • For Stainless Steel, Super Alloy • Sharp Geometry
<p>-GN (General Type)</p>		<ul style="list-style-type: none"> • First Choice for General Application
<p>-TR</p>		<ul style="list-style-type: none"> • For Hardened Steels • Reinforced Geometry
<p>...W / ...N</p>		<ul style="list-style-type: none"> • For Hardened Material and Cast Irons

Milling Inserts Overview

Recommended Cutting Conditions : p.223

TURNING
PARTING & GROOVING
MILLING
DRILLING
TECHNICAL INFORMATION

A 2 Corner	 Positive	ADKT	ADKT 1505	p. 149
		AOMT	AOMT 1236	p. 149
		APGT	APGT 1003, 1604	p. 150
		APKT	APKT 1003, 1604	p. 151
		APMT	APMT 1135, 1504, 1604	p. 152
E 4 Corner	 Negative	ENMX	ENMX 0604 ENMX 0905	p. 153
O Octagon	 Positive	ODMT / ODMW	ODMT / ODMW 0605	p. 155
		OFER	OFER 0704	p. 156
	 Negative	ONMU / ONHU	ONMU / ONHU 0806	
P 10 Corner	 Negative	PNMU	PNMU1206	p. 158
R Round	 Positive Round	RDKT / RDKW	RDKT 0802, 10T3, 1204, 1604 RDKW 0501, 0702, 0802, 10T3, 1204	p. 159
		RDMT / RDMW	RDMT 0802, 0803, 10T3, 1204 RDMW 0802, 10T3, 1204	p. 160
		RPMT / RPMW	RPMT 08T2, 10T3, 1204 RPMW 1003, 1204	p. 161
S Square	 High Feed	SDMT / SDMW	SDMT 1204, SDMW 1204	p. 163
		SDCN (45°) / SDKN	SDKN, SDCN 1203, 1504	p. 162
	 Positive	SEGT	SEGT12T3, 1204	p. 164
		SEKR (45°) / SEKN	SEKR, SEKN 1203	p. 167
		SEKT	SEKT 12T3, 1204	p. 165
		SEMT	SEMT1204, 13T3	p. 166
		SPMT	SPMT 1204	p. 170
	 Negative	SNMX	SNMX1206	p. 168
	 ISO	SPCN(75°) / SPKN / SPKR'	SPKN 1203, 1504 SPKR 1203 SPCN 1203, 1504	p. 169
SPUN		SPUN 1203	p. 171	
T Triangle	 Positive 3 Corner	TPKT	TPKT 1104, TPKT 1605	p. 172
	 ISO	TPCN(90°) / TPKN / TPKR	TPKN 1603, 2204 TPKR 1603, 2204 TPCN 2204	p. 173
		TPUN	TPUN 1603	p. 174
W Trigon	 Negative 6 Corner	WNEX	WNEX0806	p. 175

Milling - Shoulder Milling - Inserts

ADKT / AOMT - Shoulder Milling Positive (2 Corner)

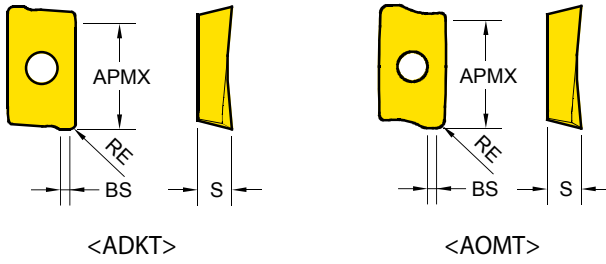

Series	APMX	IC	S
ADKT 1505	14	9.7	5.8
AOMT 1236	11	6.6	3.6

EDP 1200..

●: Stock item ○: Order made item

H20	P15	P25	P30	P30	P30	P40	K10	K15
P20			K30	M30 S30	M30	M40 S40		
YG012	YG712	YG713	YG622	YG612	YG602	YG613	YG5020	YG501
					● 0220			
					● 0755			
					● 0756			
					● 0757			

ADKT	Designation	RE (mm)	Fz (mm/tooth)	BS (mm)
------	-------------	---------	---------------	---------

ADKT
General



ADKT 150508 PDTR	0.8	0.05 ~ 0.24	1.87
ADKT 150516 PDTR	1.6	0.05 ~ 0.24	1.73
ADKT 150524 PDTR	2.4	0.05 ~ 0.24	1.20
ADKT 150532 PDTR	3.2	0.05 ~ 0.24	0.30

AOMT	Designation	RE (mm)	Fz (mm/tooth)	BS (mm)
------	-------------	---------	---------------	---------

AOMT
General



AOMT 123604 PDTR	0.4	0.03 ~ 0.06	1.07
AOMT 123608 PDTR	0.8	0.03 ~ 0.06	0.91

YG012	YG712	YG713	YG622	YG612	YG602	YG613	YG5020	YG501
					● 0217			
					● 0218	● 0613		

Milling - Shoulder Milling - Inserts
APGT - Shoulder Milling Positive (2 Corner)

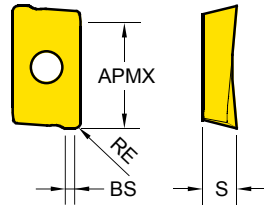

Series	APMX	IC	S
APGT 1035	9	6.7	3.6
APGT 1604	14	9.4	5.3

EDP 1200..

●: Stock item ○: Order made item

H20	P15	P25	P30	P30	P30	P40	K10	N15
P20			K30	M30	M30	M40		
			S30	S30	S40	S40		
YG012	YG712	YG713	YG622	YG612	YG602	YG613	YG5020	YG50
								● 0730
								● 0428
								● 0798

APGT

Designation

RE (mm)

Fz (mm/tooth)

BS (mm)

NEW
-AL
 Aluminium



APGT 100305 - AL	0.5	0.05 ~ 0.25	1.4
APGT 160408 - AL	0.8	0.05 ~ 0.25	1.7
APGT 160430 - AL	3.0	0.05 ~ 0.25	0.2

TURNING

PARTING & GROOVING

MILLING

DRILLING

TECHNICAL INFORMATION

Milling - Shoulder Milling - Inserts
APKT - Shoulder Milling Positive (2 Corner)

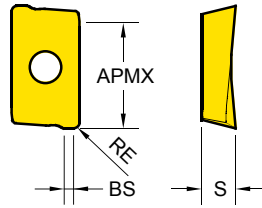



Series	APMX	IC	S
APKT 1003	9	6.7	3.6
APKT 1604	14	9.4	5.3

EDP 1200..

●: Stock item ○: Order made item

	H20	P15	P25	P30	P30	P30	P40	K10	K15
	P20			K30	M30 S30	M30	M40 S40		
YG012	●								
YG712									
YG713				○					
YG622				○					
YG612									
YG602							●		
YG613							●		
YG5020									
YG501									

APKT	Designation	RE (mm)	Fz (mm/tooth)	BS (mm)
APKT General 	APKT 100305 PDTR	0.5	0.05 ~ 0.24	0.86
	APKT 100308 PDTR	0.8	0.05 ~ 0.24	0.90
	APKT 100316 PDTR	1.6	0.05 ~ 0.24	1.03
	APKT 160404 PDTR	0.4	0.05 ~ 0.25	1.11
	APKT 160408 PDTR	0.8	0.05 ~ 0.25	1.32
	APKT 160412 PDTR	1.2	0.05 ~ 0.25	1.13
	APKT 160416 PDTR	1.6	0.05 ~ 0.25	1.13
	APKT 160424 PDTR	2.4	0.05 ~ 0.25	1.2
	APKT 160432 PDTR	3.2	0.05 ~ 0.25	0.4
	-ST Stainless Steel Super Alloy 	APKT 100305 - ST	0.5	0.05 ~ 0.12
APKT 100312 - ST		1.2	0.05 ~ 0.12	1.32
APKT 100316 - ST		1.6	0.05 ~ 0.12	1.03
APKT 160408 - ST		0.8	0.05 ~ 0.12	1.32
-TR Hardened Steel 	APKT 160404 - TR	0.4	0.05 ~ 0.40	2.12
	APKT 160408 - TR	0.8	0.05 ~ 0.40	1.32
	APKT 160412 - TR	1.2	0.05 ~ 0.40	2.40
	APKT 160416 - TR	1.6	0.05 ~ 0.40	2.40
	APKT 160424 - TR	2.4	0.05 ~ 0.40	1.50

Milling - Shoulder Milling - Inserts
APMT - Shoulder Milling Positive (2 Corner)

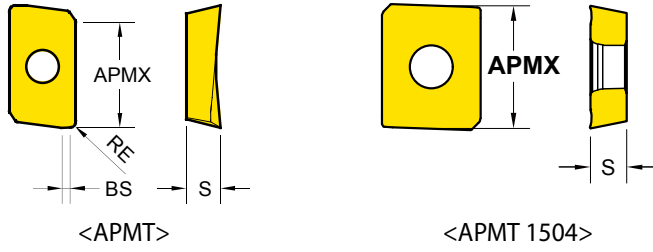

Series	APMX	IC	S
APMT 1135	9	6.2	3.50
APMT 1604	14	9.2	4.76
APMT 1504	14	12.7	4.76

EDP 1200..

●: Stock item ○: Order made item

H20	P15	P25	P30	P30	P30	P40	K10	K15
P20			K30	M30	M30	M40		
			S30	S30	S40	S40		
YG012	YG712	YG713	YG622	YG612	YG602	YG613	YG5020	YG501
● 0752		○ 0655	○ 0400		● 0009			
		○ 0654			● 0010	● 0668		
● 0751	● 0423	○ 0642	○ 0399		● 0008	● 0663		● 0464
			○ 0445		● 0276			

APMT	Designation	RE (mm)	Fz (mm/tooth)	BS (mm)
APMT General	APMT 113504 PDTR	0.4	0.05 ~ 0.24	1.26
	APMT 113508 PDTR	0.8	0.05 ~ 0.24	1.07
	APMT 160408 PDTR	0.8	0.05 ~ 0.24	1.11
APMT 1504 General	APMT 1504		0.05 ~ 0.24	

TURNING

PARTING & GROOVING

MILLING

DRILLING

TECHNICAL INFORMATION

Milling - High Feed Milling - Inserts

ENMX - High Feed Negative (4 Corners)

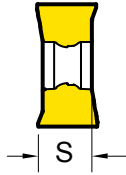
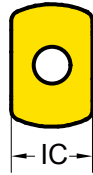

Series	IC	S
ENMX 0604	6.3	4.21
ENMX 0905	9.0	5.40

EDP 1200..

●: Stock item ○: Order made item

H20	P15	P25	P30	P30	P30	P40	K10	K15
P20			K30	M30 S30	M30	M40 S40		
YG012	YG712	YG713	YG622	YG612	YG602	YG613	YG5020	YG501
●	●	○			●	●		
0734					0474	0606		
●					●	●		
0736					0702	0703		
					●	●		
					0623	0625		
					●	●		
					0705	0706		
●	●	○			●			
0733	0504	0636			0459			
●					●			
0735					0600			

ENMX	Designation	RE (mm)	Fz (mm/tooth)	BS (mm)
ENMX General	ENMX 0604		0.3 ~ 2.0	
	ENMX 0905		0.3 ~ 2.5	
- ST Stainless Steel	ENMX 0604 - ST		0.1 ~ 0.8	
	ENMX 0905 - ST		0.2 ~ 1.2	
- TR Hardened Steel	ENMX 0604 - TR		0.3 ~ 2.5	
	ENMX 0905 - TR		0.3 ~ 3.0	

Milling - High Feed Milling - Inserts

ENMX - High Feed Negative (4 Corners) Technical Information

ENMX 0604

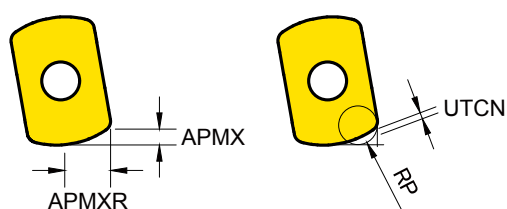

Unit:mm

DCX Cutting Diameter Maximum	APMXR Radial AP Max	RP Programmed Corner R	UTCN Uncut Thickness	Overcut
16	3.5	R2.0	0.31	0.00
16~	3.7	R2.5	0.18	0.18
		R3.0	0.07	0.36

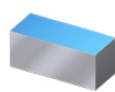

General



Plunging



Ramping

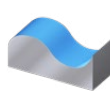

Profiling

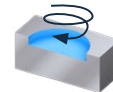

Helical Interpolation

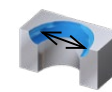

Enlarge Hole

DCX External Cutter Diameter	APMX Maximum Depth of Cut	APMXR Maximum Radial Depth of Cut	RMPX Maximum Ramping Angle(°)	RP Programmed Corner Radius	UTCN Uncut Thickness	Diameter Minimum Cutting Diameter	Diameter Maximum Cutting Diameter	Pitch Helical Interpolation Pitch	Ae Enlarge Width
16	0.9	3.5	2.4°	R2.0	0.3	22	32	0.9	12.5
17	0.9	3.5	1.9°	R2.0	0.3	24	34	0.9	13.5
20	1	3.7	1.8°	R2.0	0.31	29	40	1	16.3
21	1	3.7	1.8°	R2.0	0.31	31	42	1	17.3
25	1	3.7	1.2°	R2.0	0.31	39	50	1	21.3
26	1	3.7	1.2°	R2.0	0.31	41	52	1	22.3
32	1	3.7	0.8°	R2.0	0.31	53	64	1	28.3
33	1	3.7	0.8°	R2.0	0.31	55	66	1	29.3
40	1	3.7	0.6°	R2.0	0.31	69	80	1	36.3
50	1	3.7	0.5°	R2.0	0.31	89	98	1	46.3
63	1	3.7	0.4°	R2.0	0.31	115	126	1	59.3

ENMX 0905

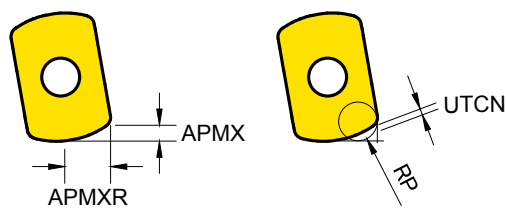

Unit:mm

APMXR Radial AP Max	RP Programmed Corner R	UTCN Uncut Thickness	Overcut
4.7	R2.5	0.56	0
	R3.0	0.40	0.10
	R3.5	0.24	0.25
	R4.0	0.10	0.41
	R4.5	0	0.49

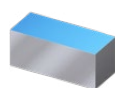

General



Plunging



Ramping

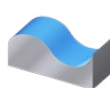

Profiling

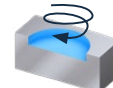

Helical Interpolation

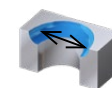

Enlarge Hole

DCX External Cutter Diameter	APMX Maximum Depth of Cut	APMXR Maximum Radial Depth of Cut	RMPX Maximum Ramping Angle(°)	RP Programmed Corner Radius	UTCN Uncut Thickness	Diameter Minimum Cutting Diameter	Diameter Maximum Cutting Diameter	Pitch Helical Interpolation Pitch	Ae Enlarge Width
25	1.5	5	3.8°	2.5	0.56	42	50	1.5	20
26	1.5	5	3.4°	2.5	0.56	44	52	1.5	21
32	1.5	5	2.3°	2.5	0.56	56	64	1.5	27
33	1.5	5	2.2°	2.5	0.56	58	66	1.5	28
40	1.5	5	1.6°	2.5	0.56	72	80	1.5	35
50	1.5	5	1.1°	2.5	0.56	92	100	1.5	45
63	1.5	5	0.8°	2.5	0.56	118	126	1.5	57
80	1.5	5	0.6°	2.5	0.56	152	160	1.5	74

Milling - Face Milling - Inserts

ODMT, ODMW - Face Milling Positive (8 Corners)

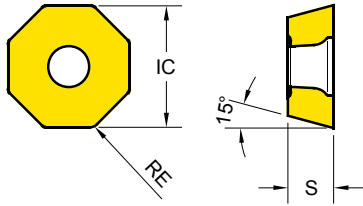

Series	IC	S
ODM* 0605	15.9	5.6

EDP 1200..

●: Stock item ○: Order made item

H20	P15	P25	P30	P30	P30	P40	K10	K15
P20			K30	M30 S30	M30	M40 S40		
YG012	YG712	YG713	YG622	YG612	YG602	YG613	YG5020	YG501
		○ 0659			● 0030	● 0675		
					● 0031			

ODMT ODMW	Designation	RE (mm)	Fz (mm/tooth)	BS (mm)
ODMT General 	ODMT 060508	0.8	0.05 ~ 0.30	
ODMW Hard Materials 	ODMW 060508	0.8	0.05 ~ 0.30	

TURNING

PARTING & GROOVING

MILLING

DRILLING

TECHNICAL INFORMATION

Milling - Face Milling - Inserts

OFER, OFMT - Face Milling Positive (8 Corners)

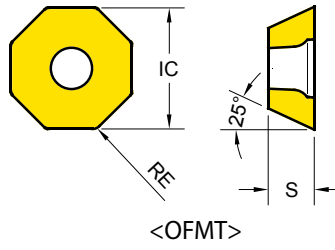
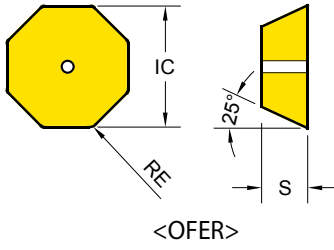

Series	IC	S
OFER 0704	18.05	4.78
OFMT 05T3	12.73	4.06

EDP 1200..

●: Stock item ○: Order made item

H20	P15	P25	P30	P30	P30	P40	K10	K15
P20			K30	M30	M30	M40		
			S30	S30	S30	S40		
YG012	YG712	YG713	YG622	YG612	YG602	YG613	YG5020	YG501
					● 0209			

OFER

Designation

RE (mm)

Fz (mm/tooth)

BS (mm)

OFER
General



OFER 070405

0.5

0.05 ~ 0.30

OFMT

Designation

RE (mm)

Fz (mm/tooth)

BS (mm)

OFMT
General



OFMT 05T308

0.8

0.05 ~ 0.20

YG012	YG712	YG713	YG622	YG612	YG602	YG613	YG5020	YG501
					● 0032			

TURNING

PARTING & GROOVING

MILLING

DRILLING

TECHNICAL INFORMATION

Milling - Face Milling - Inserts

ONHU / ONMU - Face Milling Negative (16 Corners)

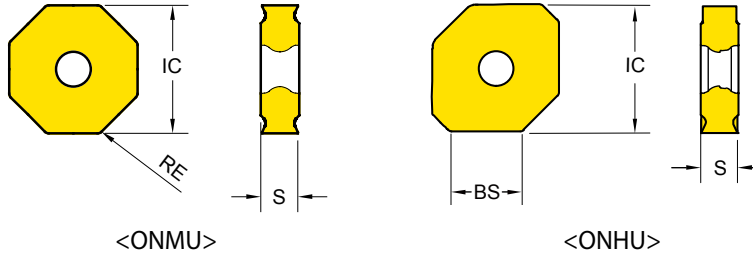

Series	IC	S
ON*U 0806	20.2	5.8

EDP 1200..

●: Stock item ○: Order made item

H20	P15	P25	P30	P30	P30	P40	K10	K15
P20			K30	M30	M30	M40		
			S30	S30	S30	S40		
YG012	YG712	YG713	YG622	YG612	YG602	YG613	YG5020	YG501
							● 0482	● 0496
	● 0609	○ 0657			● 0233	● 0670	● 0414	
						● 0615	● 0542	
							● 0707	

ONMU ONHU	Designation	RE (mm)	Fz (mm/tooth)	BS (mm)
--------------	-------------	---------	---------------	---------



ONHU 080612	1.2	0.08 ~ 0.25	10.6
-------------	-----	-------------	------



ONMU 080608	0.8	0.05 ~ 0.35	
ONMU 080612	1.2	0.05 ~ 0.35	
ONMU 080620	2.0	0.05 ~ 0.35	

Milling - Face Milling - Inserts

PNMU - Face Milling Negative (10 Corners)

Series	KRINS	IC	S
PNMU 1206	36	14.0	5.84

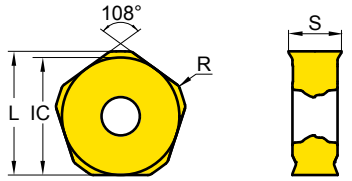

EDP 1200..

●: Stock item ○: Order made item

H20	P15	P25	P30	P30	P30	P40	K10	K15
P20			K30	M30	M30	M40		
			S30	S30	S40	S40		
YG012	YG712	YG713	YG622	YG612	YG602	YG613	YG5020	YG5016
● 0753	● 0596	○ 0645		● 0826	● 0535	● 0671	● 0534	● 0538
					● 0761	● 0760		

PNMU	Designation	RE (mm)	Fz (mm/tooth)	BS (mm)
PNMU General 	PNMU 1206ZNN	0.8	0.05 ~ 0.50	2.10
	PNMU 1206-ST	0.8	0.05 ~ 0.30	2.10
- ST Stainless Steel Super Alloy 				

TURNING

PARTING & GROOVING

MILLING

DRILLING

TECHNICAL INFORMATION

Milling - Profiling - Inserts

RDKT / W-Profiling Positive (Round)

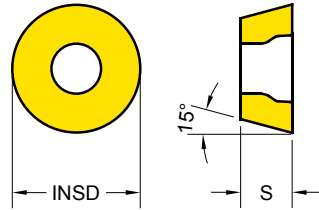

Series	INSD	S	Series	INSD	S
RDK* 0501	5	1.4	RDK* 10T3	10	4.0
RDK* 0702	7	2.4	RDK* 1204	12	4.8
RDK* 0802	8	2.4	RDK* 1604	16	4.8

EDP 1200..

●: Stock item ○: Order made item

H20	P15	P25	P30	P30	P30	P40	K10	K15
P20			K30	M30 S30	M30	M40 S40		
YG012	YG712	YG713	YG622	YG612	YG602	YG613	YG5020	YG501
					● 0035			
		○ 0651			● 0041			
		○ 0635			● 0034	● 0678		
					● 0539			
					● 0292			
					● 0293	● 0620		
					● 0294	● 0621		
● 0745			○ 0339		● 0284			
● 0744			○ 0338		● 0285			
● 0743		○ 0650	○ 0340		● 0272			
			○ 0412		● 0207			
		○ 0652	○ 0439		● 0208			
			○ 0440		● 0043			
			○ 0441		● 0040			
		○ 0647	○ 0442		● 0042			
● 0817					● 0720			

RDKT RDKW	Designation	Fz (mm/tooth)
RDKT General	RDKT 0802M0	0.05 ~ 0.25
	RDKT 10T3M0	0.05 ~ 0.30
	RDKT 1204M0	0.05 ~ 0.50
	RDKT 1604M0	0.05 ~ 0.50
-ST Stainless Steel Super Alloy	RDKT 0802M0 - ST	0.05 ~ 0.15
	RDKT 10T3M0 - ST	0.05 ~ 0.20
	RDKT 1204M0 - ST	0.05 ~ 0.30
-TR Hardened Steel	RDKT 0802M0 - TR	0.05 ~ 0.35
	RDKT 10T3M0 - TR	0.05 ~ 0.40
	RDKT 1204M0 - TR	0.05 ~ 0.60
RDKW Hard Materials	RDKW 0501M0	0.05 ~ 0.20
	RDKW 0702M0	0.05 ~ 0.25
	RDKW 0802M0	0.05 ~ 0.30
	RDKW 10T3M0	0.05 ~ 0.40
	RDKW 1204M0	0.05 ~ 0.60
	RDKW 1604M0	0.05 ~ 0.60

Milling - Profiling - Inserts

RDMT / W-Profiling Positive (Round)

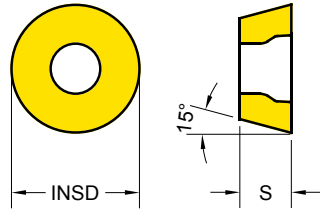

Series	INSD	S	Series	INSD	S
RDM* 0602	6	2.38	RDM* 10T3	10	3.97
RDM* 0802	8	2.38	RDM* 1204	12	4.76
RDM* 0803	8	3.18			

EDP 1200..

●: Stock item ○: Order made item

H20	P15	P25	P30	P30	P30	P40	K10	K15
P20			K30	M30 S30	M30	M40 S40		
YG012	YG712	YG713	YG622	YG612	YG602	YG613	YG5020	YG501
					● 0693			
					● 0245			
					● 0225			
					● 0246			
					● 0226			
					● 0227			
					● 0228			
					● 0229			

RDMT RDMW	Designation	Fz (mm/tooth)
RDMT General 	RDMT 0602M0	0.05 ~ 0.20
	RDMT 0802M0	0.05 ~ 0.25
	RDMT 0803M0	0.05 ~ 0.25
	RDMT 10T3M0	0.05 ~ 0.30
	RDMT 1204M0	0.05 ~ 0.50
RDMW Hard Materials 	RDMW 0802M0	0.05 ~ 0.30
	RDMW 10T3M0	0.05 ~ 0.40
	RDMW 1204M0	0.05 ~ 0.60

Milling - Profiling - Inserts

RPMT / W - Profiling Positive (Round)

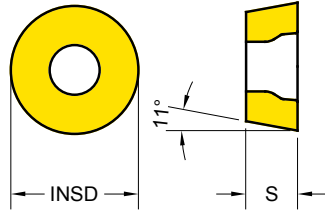

Series	INSD	S	Series	INSD	S
RPM* 08T2	8	2.78	RPM* 10T3	10	3.97
RPM* 1003	10	3.18	RPM* 1204	12	4.76

EDP 1200..

●: Stock item ○: Order made item

H20	P15	P25	P30	P30	P30	P40	K10	K15
P20			K30	M30 S30	M30	M40 S40		
YG012	YG712	YG713	YG622	YG612	YG602	YG613	YG5020	YG501
		○ 0660			● 0038	● 0676		
		○ 0644			● 0036	● 0665		
	● 0415	○ 0643	○ 0401		● 0037	● 0664		● 0462
					● 0230	● 0667		
		○ 0646	○ 0402		● 0204			
		○ 0648			● 0039			

RPMT RPMW	Designation	Fz (mm/tooth)
RPMT General	RPMT 08T2M0	0.05 ~ 0.25
	RPMT 10T3M0	0.05 ~ 0.30
	RPMT 1204M0	0.05 ~ 0.50
-ST Stainless Steel Super Alloy	RPMT 1204M0 -ST	0.05 ~ 0.30
RPMW Hard Materials	RPMT 1003M0	0.05 ~ 0.40
	RPMT 1204M0	0.05 ~ 0.60

Milling - Face Milling - Inserts
SDCN, SDKN - Face Milling Positive (4 Corners ISO)

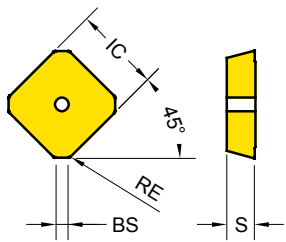



Series	IC	S
SD** 1203	12.70	3.18
SD** 1504	15.88	4.76

EDP 1200..
 ●: Stock item ○: Order made item

EDP 1200..
 ●: Stock item ○: Order made item

H20	P15	P25	P30	P30	P30	P40	K10	K15
P20			K30	M30 S30	M30	M40 S40		
YG012	YG712	YG713	YG622	YG612	YG602	YG613	YG5020	YG501
	● 0135							
	● 0150							
	● 0201							
					● 0058			
					● 0253			
					● 0251			
				● 0762				
					● 0059			
					● 0288			
					● 0286			

SDCN SDKN	Designation	RE (mm)	Fz (mm/tooth)	BS (mm)
SDCN Ground insert 	SDCN 1203 AESN - M	1.0	0.05 ~ 0.20	2.04
	SDCN 1504 AESN - M	1.0	0.05 ~ 0.20	2.19
	SDCN 1504 AESN - MR	1.0	0.05 ~ 0.20	2.19
SDKN Hard Materials 	SDKN 1203 AETN	0.5	0.05 ~ 0.30	1.85
	SDKN 1203 AETN - PW	0.4	0.05 ~ 0.30	1.98
	SDKN 1203 AETN - GW	1.3	0.05 ~ 0.30	1.85
	SDKN 1203 AESN - GW	1.3	0.05 ~ 0.30	1.85
	SDKN 1504 AETN	0.45	0.05 ~ 0.30	2.00
	SDKN 1504 AETN - PW	0.4	0.05 ~ 0.30	1.95
	SDKN 1504 AETN - GW	1.3	0.05 ~ 0.30	2.05

- PW : for Improved Surface Roughness
- GW : Ground Wiper
- M : for Mold & Die
- MR : for Mold & Die Roughing

TURNING

PARTING & GROOVING

MILLING

DRILLING

TECHNICAL INFORMATION

Milling - High Feed Milling - Inserts
SDMT / W - High Feed Positive (4 Corners)

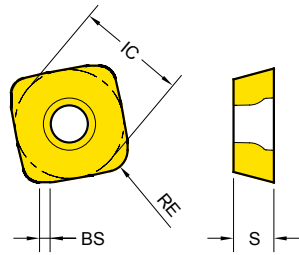

Series	IC	S
SDM* 1204	12.7	4.7

EDP 1200..

●: Stock item ○: Order made item

H20	P15	P25	P30	P30	P30	P40	K10	K15
P20			K30	M30 S30	M30	M40 S40		
YG012	YG712	YG713	YG622	YG612	YG602	YG613	YG5020	YG501
					● 0274	● 0666		
● 0737	○ 0634	○ 0341		● 0273	● 0691			

SDMT SDMW	Designation	RE (mm)	Fz (mm/tooth)	BS (mm)
-ST Stainless Steel Super Alloy	SDMT 120420 - ST	1.9	0.60 ~ 1.20	1.45
SDMW Hard Materials	SDMW 120420	1.9	0.60 ~ 1.40	1.4

Technical Information

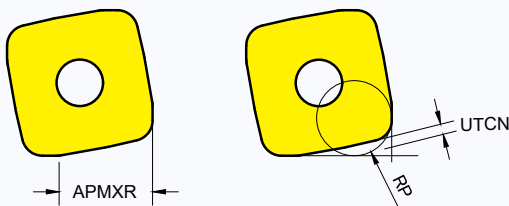

APMXR Radial AP Max	RP Programmed Corner R	UTCN Uncut Thickness
8.6	R3.5	0.94

Milling - Face Milling - Inserts

SEGT - Face Milling Positive (4 Corners)

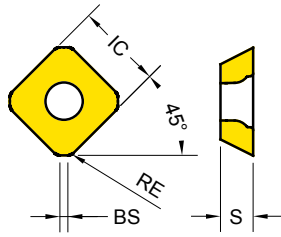

Series	IC	S
SEGT 1204	12.74	4.91
SEGT 12T3	13.40	4.03

EDP 1200..

●: Stock item ○: Order made item

H20	P15	P25	P30	P30	P30	P40	K10	N15
P20			K30	M30	M30	M40		
			S30	S30	S40	S40		
YG012	YG712	YG713	YG622	YG612	YG602	YG613	YG5020	YG50
								● 0467

SEGT 1204

Designation RE (mm) Fz (mm/tooth) BS (mm)

SEGT 1204 - AL 1.2 0.05 ~ 0.30 2.01

-AL
Aluminium



SEGT 12T3

Designation RE (mm) Fz (mm/tooth) BS (mm)

SEGT 12T3 - AL 1.2 0.05 ~ 0.30 1.94

-AL
Aluminium



TURNING

PARTING & GROOVING

MILLING

DRILLING

TECHNICAL INFORMATION

Milling - Face Milling - Inserts

SEKT - Face Milling Positive (4 Corners)

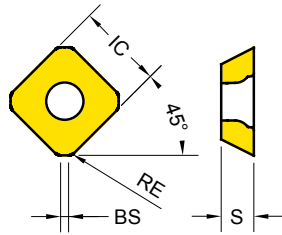

Series	IC	S
SEKT 1204	12.7	4.9
SEKT 12T3	13.4	4

EDP 1200..

●: Stock item ○: Order made item

H20	P15	P25	P30	P30	P30	P40	K10	K15
P20			K30	M30 S30	M30	M40 S40		
YG012	YG712	YG713	YG622	YG612	YG602	YG613	YG5020	YG501
			○ 0416		● 0055			
					● 0257	● 0722		

SEKT 1204		Designation	RE (mm)	Fz (mm/tooth)	BS (mm)
SEKT 1204 General 	SEKT 1204 AFTN	1.1	0.20 ~ 0.35	1.18	
	SEKT 1204 -ST	1.1	0.08 ~ 0.30	2.00	

SEKT 12T3		Designation	RE (mm)	Fz (mm/tooth)	BS (mm)
SEKT 12T3 General 	SEKT 12T3 AGTN	1.5	0.05 ~ 0.24	1.30	
	SEKT 12T3 -ST	1.5	0.05 ~ 0.12	2.00	

YG012	YG712	YG713	YG622	YG612	YG602	YG613	YG5020	YG501
					● 0056			
					● 0271	● 0689		

Milling - Face Milling - Inserts

SEMT - Face Milling Positive (4 Corners)

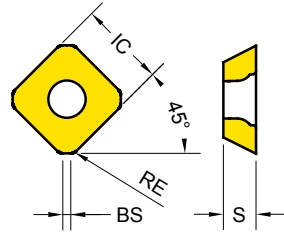

Series	IC	S
SEMT1204	12.92	5.1
SEMT13T3	13.40	4.0

EDP 1200..

●: Stock item ○: Order made item

H20	P15	P25	P30	P30	P30	P40	K10	K15
P20			K30	M30 S30	M30	M40 S40		
YG012	YG712	YG713	YG622	YG612	YG602	YG613	YG5020	YG501
					● 0052			
						● 0203		

SEMT	Designation	RE (mm)	Fz (mm/tooth)	BS (mm)
SEMT 1204 General	SEMT 1204 AFTN	1.2	0.05 ~ 0.24	1.24
SEMT 13T3 General	SEMT 13T3 AGSN	1.5	0.05 ~ 0.24	1.31

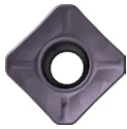

TURNING

PARTING & GROOVING

MILLING

DRILLING

TECHNICAL INFORMATION

Milling - Face Milling - Inserts

SEKR / N - Face Milling Positive (4 Corners ISO)

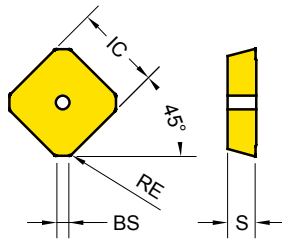

Series	IC	S
SEK* 1203	12.7	3.2

EDP 1200..

●: Stock item ○: Order made item

H20	P15	P25	P30	P30	P30	P40	K10	K15
P20			K30	M30 S30	M30	M40 S40		
YG012	YG712	YG713	YG622	YG612	YG602	YG613	YG5020	YG501
					● 0051			
					● 0296			
					● 0054			
				● 0774	● 0304			
					● 0297			

SEKR SEKN	Designation	RE (mm)	Fz (mm/tooth)	BS (mm)
SEKR General	SEKR 1203 AFTN	0.4	0.05 ~ 0.23	1.40
	SEKR 1203 AFTN - PW	0.4	0.05 ~ 0.24	2.00
SEKN Hard Materials	SEKN 1203 AFTN	0.4	0.05 ~ 0.30	1.40
	SEKN 1203 AFTN - GW	0.4	0.05 ~ 0.33	2.00
	SEKN 1203 AFTN - PW	0.4	0.05 ~ 0.33	2.00

- PW : for Improved Surface Roughness
- GW : Ground Wiper

Milling - Face Milling - Inserts

SNMX - Face Milling Negative (8 Corners)

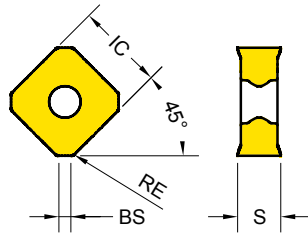

Series	IC	S
SNMX 1206	12.7	6.25

TURNING

PARTING & GROOVING

MILLING

DRILLING

TECHNICAL INFORMATION

EDP 1200..

●: Stock item ○: Order made item

H20	P15	P25	P30	P30	P30	P40	K10	K15
P20			K30	M30 S30	M30	M40 S40		
YG012	YG712	YG713	YG622	YG612	YG602	YG613	YG5020	YG501
● 0754		○ 0658			● 0231	● 0674	● 0460	
	● 0732						● 0731	● 0686

SNMX

Designation

RE (mm)

Fz (mm/tooth)

BS (mm)

SNMX 1206 ANN	0.8	0.05 ~ 0.24	1.70
SNMX 1206 QNN	0.8	0.05 ~ 0.24	1.99

SNMX
General

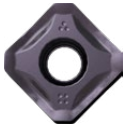

Milling - Face Milling - Inserts

SPCN, SPKN / R - Face Milling Positive (4 Corners ISO)

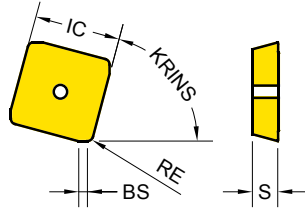

Series	KRINS	IC	S
SP** 1203	75°	12.70	3.18
SP** 1504	75°	15.88	4.76

EDP 1200..

●: Stock item ○: Order made item

H20	P15	P25	P30	P30	P30	P40	K10	K15
P20			K30	M30 S30	M30	M40 S40		
YG012	●							
YG712	●							
YG713	●							
YG622	●							
YG612								
YG602								
YG613								
YG5020								
YG501								

SPCN SPKN SPKR	Designation	RE (mm)	Fz (mm/tooth)	BS (mm)
SPCN Ground insert	SPCN 1203 EDSR - M	0.8	0.10 ~ 0.20	1.82
	SPCN 1203 EDSR - MR	0.8	0.10 ~ 0.20	1.77
	SPCN 1504 EDSR - M	0.8	0.10 ~ 0.20	1.92
	SPCN 1504 EDSR - MR	0.8	0.10 ~ 0.20	1.86
SPKN Hard Materials	SPKN 1203 EDTR	0.8	0.05 ~ 0.30	1.40
	SPKN 1203 EDTR - GW	0.6	0.05 ~ 0.38	1.50
	SPKN 1203 EDTR - PW	0.8	0.05 ~ 0.38	1.50
	SPKN 1504 EDTR	0.8	0.05 ~ 0.24	1.30
	SPKN 1504 EDTR - GW	0.8	0.05 ~ 0.38	2.20
	SPKN 1504 EDTR - PW	0.8	0.05 ~ 0.38	2.13
SPKR General	SPKR 1203 EDTR	0.8	0.05 ~ 0.24	1.40
	SPKR 1203 EDTR - PW	0.8	0.05 ~ 0.11	1.54

- PW : for Improved Surface Roughness
- GW : Ground Wiper
- M : for Mold & Die
- MR : for Mold & Die Roughing

Milling - Face Milling - Inserts

SPMT - Universal Positive (4 Corners)

Series	AS	IC	S
SPMT 1204	11°	12.7	4.81

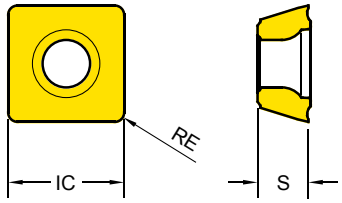

EDP 1200..

●: Stock item ○: Order made item

H20	P15	P25	P30	P30	P30	P40	K10	K15
P20			K30	M30 S30	M30	M40 S40		
YG012	YG712	YG713	YG622	YG612	YG602	YG613	YG5020	YG501
					● 0223			

SPMT	Designation	RE (mm)	Fz (mm/tooth)	BS (mm)
------	-------------	---------	---------------	---------

SPMT
General



SPMT 120408	0.8	0.05 ~ 0.24	

Milling - Face Milling - Inserts

SPUN - Universal Positive (4 Corners ISO)

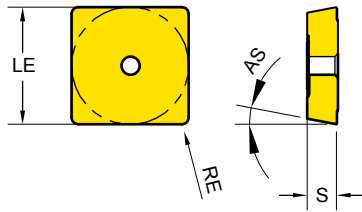

Series	AS	IC	S
SPUN 1203	11°	12.7	3.2

EDP 1200..

●: Stock item ○: Order made item

H20	P15	P25	P30	P30	P30	P40	K10	K15
P20			K30	M30 S30	M30	M40 S40		
YG012	YG712	YG713	YG622	YG612	YG602	YG613	YG5020	YG501
					● 0224			

SPUN	Designation	RE (mm)	Fz (mm/tooth)	BS (mm)
------	-------------	---------	---------------	---------

SPUN
General



SPUN 120308	0.8	0.05 ~ 0.29	

TURNING

PARTING & GROOVING

MILLING

DRILLING

TECHNICAL INFORMATION

Milling - Shoulder Milling - Inserts
TPKT - Shoulder Milling Positive (3 Corner ISO)

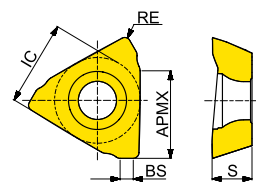

Series	KRINS	IC	S
TP** 1104	90	7.54	4.28
TP** 1605	90	11.66	5.38

EDP 1200..

●: Stock item ○: Order made item

H20	P15	P25	P30	P30	P30	P40	K10	K15
P20			K30	M30	M30	M40		
			S30	S30	S40	S40		
YG012	YG712	YG713	YG622	YG612	YG602	YG613	YG5020	YG501
●	●			●			●	
0802	0807			0801			0808	
●	●			●			●	
0804	0811			0803			0812	
●	●			●			●	
0806	0815			0805			0816	
●	●			●			●	
0781	0779			0718			0780	
●	●			●			●	
0785	0786			0784			0787	
●	●			●			●	
0789	0790			0788			0791	
				●		●		
				0809		0810		
				●		●		
				0813		0814		
				●		●		
				0758		0759		

TPKT	Designation	RE (mm)	Fz (mm/tooth)	BS (mm)
<p>NEW</p> <p>TPKT General</p>	TPKT 110404R - GN	0.4	0.05 ~ 0.24	1.60
	TPKT 110408R - GN	0.8	0.05 ~ 0.24	1.15
	TPKT 110416R - GN	1.6	0.05 ~ 0.24	0.60
	TPKT 160508R - GN	0.8	0.05 ~ 0.27	1.79
	TPKT 160516R - GN	1.6	0.05 ~ 0.27	1.20
	TPKT 160524R - GN	2.4	0.05 ~ 0.27	0.70
<p>NEW</p> <p>-ST Stainless Steel Super Alloy</p>	TPKT 110404R - ST	0.4	0.05 ~ 0.15	1.60
	TPKT 110408R - ST	0.8	0.05 ~ 0.15	1.15
	TPKT 160508R - ST	0.8	0.05 ~ 0.15	0.60

TURNING

PARTING & GROOVING

MILLING

DRILLING

TECHNICAL INFORMATION

Milling - Shoulder Milling - Inserts

TPCN / TPKN / KR - Shoulder Milling Positive (3 Corner ISO)

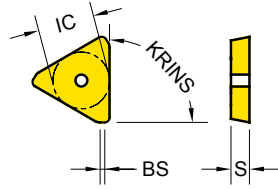

Series	KRINS	IC	S
TP** 1603	90	9.53	3.18
TP** 2204	90	12.7	4.85

EDP 1200..

●: Stock item ○: Order made item

H20	P15	P25	P30	P30	P30	P40	K10	K15
P20			K30	M30 S30	M30	M40 S40		
YG012	YG712	YG713	YG622	YG612	YG602	YG613	YG5020	YG501
	● 0180							
	● 0202							
					● 0062			
					● 0306			
					● 0302			
					● 0063			
					● 0307			
					● 0303			
					● 0060	● 0690		
					● 0300			
					● 0061	● 0715		
					● 0301			

TPCN TPKN TPKR	Designation	RE (mm)	Fz (mm/tooth)	BS (mm)
TPCN Ground insert	TPCN 2204 PDSR - M		0.05 ~ 0.20	1.76
	TPCN 2204 PDSR - MR		0.05 ~ 0.20	1.76
TPKN Hard Materials	TPKN 1603 PDTR		0.05 ~ 0.21	1.2
	TPKN 1603 PDTR - GW		0.05 ~ 0.15	1.6
	TPKN 1603 PDTR - PW		0.05 ~ 0.30	1.2
	TPKN 2204 PDTR		0.05 ~ 0.24	1.7
	TPKN 2204 PDTR - GW		0.05 ~ 0.45	2.5
	TPKN 2204 PDTR - PW		0.05 ~ 0.29	1.7
TPKR General	TPKR 1603 PDTR		0.15 ~ 0.28	1.2
	TPKR 1603 PDTR - PW		0.11 ~ 0.20	1.2
	TPKR 2204 PDTR		0.18 ~ 0.35	1.7
	TPKR 2204 PDTR - PW		0.18 ~ 0.35	1.7

- PW : for Improved Surface Roughness
- GW : Ground Wiper
- M : for Mold & Die
- MR : for Mold & Die Roughing

Milling - Shoulder Milling - Inserts
TPUN - Universal Positive (3 Corners ISO)

- TURNING
- PARTING & GROOVING
- MILLING**
- DRILLING
- TECHNICAL INFORMATION

Series	IC	S
TPUN 1603	9.53	3.18

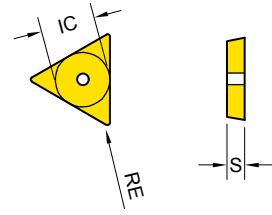

EDP 1200..

●: Stock item ○: Order made item

H20	P15	P25	P30	P30	P30	P40	K10	K15
P20			K30	M30 S30	M30	M40 S40		
YG012	YG712	YG713	YG622	YG612	YG602	YG613	YG5020	YG501
					● 0064			

TPUN	Designation	RE (mm)	Fz (mm/tooth)	BS (mm)
------	-------------	---------	---------------	---------

TPUN



TPUN 160308	0.8	0.08~0.15	

Milling - Shoulder Milling - Inserts

WNEX - Shoulder Milling Negative (6 Corners) NEW

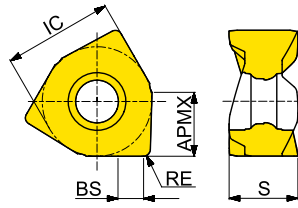

Series	IC	S
WNE* 0806	12.9	6.25

EDP 1200..

●: Stock item ○: Order made item

H20	P15	P25	P30	P30	P30	P40	K10	K15
P20			K30	M30 S30	M30	M40 S40		
YG012	YG712	YG713	YG622	YG612	YG602	YG613	YG5020	YG501
●	●			●			●	
0856	0857			0855			0858	
●	●			●		●	●	●
0859	0792			0854		0793	0794	0795
●	●			●			●	
0877	0878			0885			0879	
●	●			●			●	
0861	0862			0860			0863	
●	●			●			●	
0882	0883			0886			0884	
				●		●		
				0864		0865		
				●		●		
				0866		0867		
				●		●		
				0875		0876		
				●		●		
				0868		0869		
				●		●		
				0880		0881		

WNEX	Designation	RE (mm)	Fz (mm/tooth)	BS (mm)
NEW WNEX General	WNEX 080604R - GN	0.4	0.05 ~ 0.26	3.2
	WNEX 080608R - GN	0.8	0.05 ~ 0.26	2.8
	WNEX 080612R - GN	1.2	0.05 ~ 0.26	2.4
	WNEX 080616R - GN	1.6	0.05 ~ 0.26	2.0
	WNEX 080620R - GN	2.0	0.05 ~ 0.26	1.6
NEW -ST Stainless Steel Super Alloy	WNEX 080604R - ST	0.4	0.05 ~ 0.19	3.6
	WNEX 080608R - ST	0.8	0.05 ~ 0.19	3.3
	WNEX 080612R - ST	1.2	0.05 ~ 0.19	2.8
	WNEX 080616R - ST	1.6	0.05 ~ 0.19	2.4
	WNEX 080620R - ST	2.0	0.05 ~ 0.19	2.0





Milling Cutters Overview

Mounting Bolt : p. 197

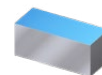

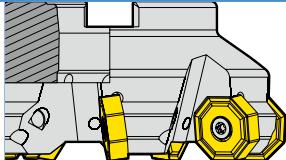
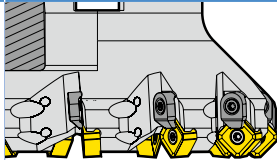
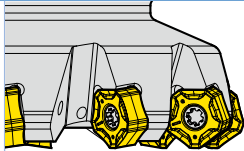
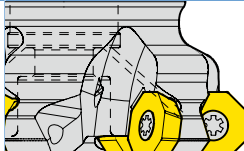
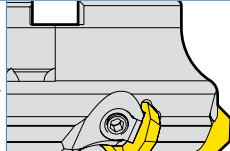
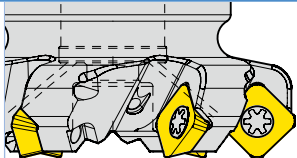
Face Milling

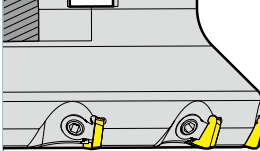

Negative Octagonal		Negative Square		
Cutter	 ONMU 0806	 SNMX 1206		
APMX	5.5		6	
DC	Ø63~315		Ø50~200	
page	185		192	
Negative 10 Corner		Positive Octagonal		
Cutter	 PNMU 1206	 ODMT/ODMW 0605	 OFER 0704	
APMX	4	3.5	5	
DC	Ø50~125	Ø63~125	Ø63~160	
page	186	184	184	
Positive Square			ISO	
Cutter	 SEKT 1204	 SEKT 12T3	 SEGT 1204	 SPKN/SPKR/SPCN 1203
APMX	6	6	6	8
DC	Ø40~160	Ø50~160	Ø50~160	Ø50~200
page	190	190	190	191

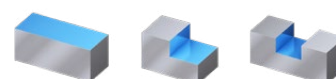
Shoulder Milling

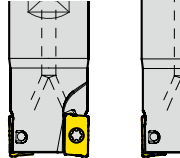
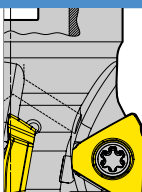
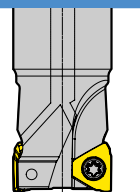

2 Corner Positive		ISO	
Cutter	 	APKT 1003	APKT 1604
APMX		9	14
DC		Ø16~100	Ø25~200
page		178-179	180-181
3 Corner Positive		ISO	
Cutter	 	 TPKN/TPKR/TPCN 1603	 TPKN/TPKR/TPCN 2204
APMX	7.0	11.0	12
DC	20~63	32~200	Ø50~125
page	194	195	193

TURNING

PARTING & GROOVING

MILLING

DRILLING

TECHNICAL INFORMATION



 Click/Touch each page number and move to the very page!

Milling Cutters Overview

Mounting Bolt : p. 197

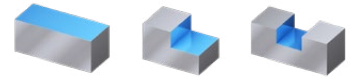

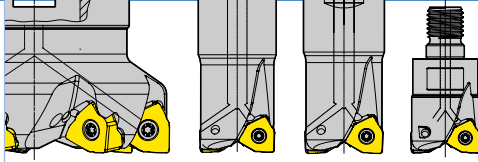
Shoulder Milling



6 Corner Negative	
Cutter	  WNEW WNEX0806
APMX	7
DC	Ø32~125
page	196

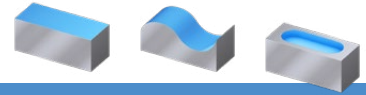

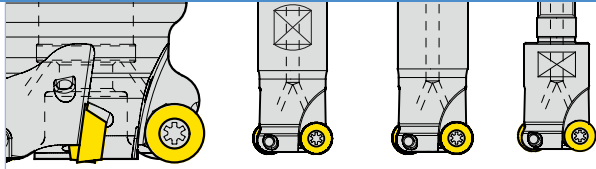

Profiling

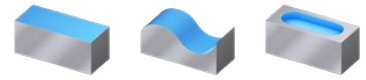

Round Positive	
Cutter	  RDKT / RDKW
	0802 10T3 1204
APMX	4 5 6
DCX	Ø16~25 Ø20~63 Ø25~100
page	187 187 188

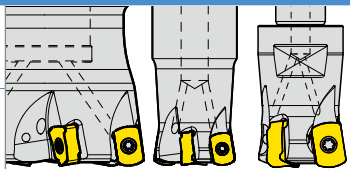
High Feed Milling



	Negative 4 Corner			Positive 4 Corner	
Cutter		 ENMX 0604	 ENMX 0604	 ENMX 0905	 SDMT/SDMW 1204
APMX		0.9	1	1.5	1.8
DCX		Ø16~18	Ø20~50	Ø25~125	Ø32~100
page		182	182	183	189

Modular Shank

Modular Shank for Modular Head	
Cutter	 M08 ~ M16
page	197

Milling - Shoulder Milling - Cutter
Cutters for APKT

Cutting Angle : 90°
 2 Corner Positive

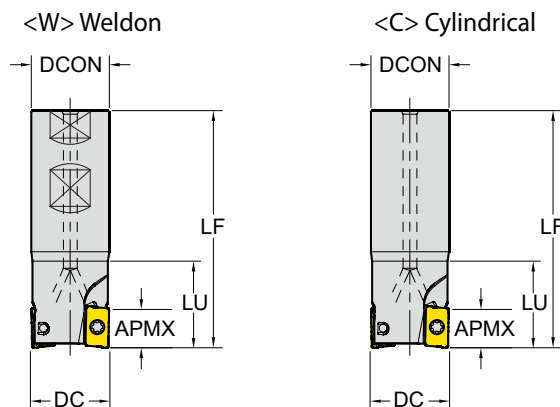

CICT : Number of Inserts
 CBDP : Connection Bore Depth

□: p. 151

Unit:mm

Series	APMX	Designation	EDP 1700..	DC	CICT	LU	LF	TYPE	DCON	CBDP	DCSFMS	PCD1	PCD2	⚡
APKT 1003	9.0	E90 - APKT10 - D16Z2C16 - L100	0083	16	2	40	100	Cylindrical	16	-	-	-	-	●
		E90 - APKT10 - D16Z2C16 - L120	0532	16	2	30	120		16	-	-	-	-	●
		E90 - APKT10 - D16Z2C16 - L150	0154	16	2	40	150		16	-	-	-	-	●
		E90 - APKT10 - D16Z2C16 - L200	0533	16	2	100	200		16	-	-	-	-	●
		E90 - APKT10 - D20Z2C20 - L250	0534	20	2	150	250		20	-	-	-	-	●
		E90 - APKT10 - D20Z3C20 - L100	0535	20	3	30	100		20	-	-	-	-	●
		E90 - APKT10 - D20Z3C20 - L120	0085	20	3	40	120		20	-	-	-	-	●
		E90 - APKT10 - D20Z3C20 - L150	0536	20	3	50	150		20	-	-	-	-	●
		E90 - APKT10 - D20Z3C20 - L200	0270	20	3	100	200		20	-	-	-	-	●
		E90 - APKT10 - D25Z3C25 - L100	0537	25	3	30	100		25	-	-	-	-	●
		E90 - APKT10 - D25Z3C25 - L120	0186	25	3	40	120		25	-	-	-	-	●
		E90 - APKT10 - D30Z4C25 - L100	0122	30	4	30	100		25	-	-	-	-	●
		E90 - APKT10 - D30Z4C25 - L120	0086	30	4	30	120		25	-	-	-	-	●
		E90 - APKT10 - D32Z4C25 - L100	0538	32	4	35	100		25	-	-	-	-	●
		E90 - APKT10 - D32Z4C25 - L150 - WOC	0539	32	4	35	150		25	-	-	-	-	X
		E90 - APKT10 - D12Z1W16 - L100	0540	12	1	30	100		Weldon	16	-	-	-	-
		E90 - APKT10 - D14Z1W16 - L100	0541	14	1	30	100	16		-	-	-	-	●
		E90 - APKT10 - D16Z2W16 - L100	0542	16	2	30	100	16		-	-	-	-	●
		E90 - APKT10 - D16Z2W16 - L85	0082	16	2	-	85	16		-	-	-	-	●
		E90 - APKT10 - D18Z2W16 - L100	0543	18	2	30	100	16		-	-	-	-	●

▶ NEXT PAGE

* Clamping Torque (Nm) 1.2Nm

APKT10	Screw (Cutter D16~D20)	Screw (Cutter D20~)	Wrench
Description	TP072505	TP072506	TPWFTP07
EDP	18000016	18000013	18000001

Milling - Shoulder Milling - Cutter Cutters for APKT

Cutting Angle : 90°
2 Corner Positive

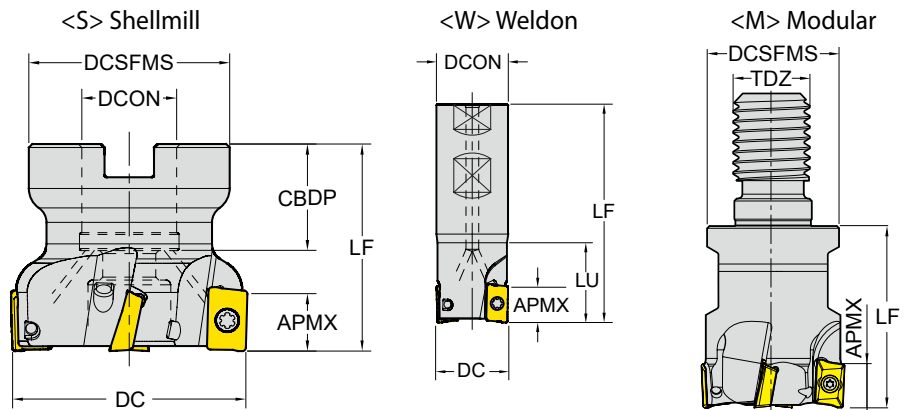

CICT : Number of Inserts
CDBP : Connection Bore Depth

o : p. 151 Unit:mm

Series	APMX	Designation	EDP 1700..	DC	CICT	LU	LF	TYPE	DCON /TDZ	CDBP	DCSFMS	PCD1	PCD2	Watermark
APKT 1003	9.0	E90 - APKT10 - D20Z3W20 - L100	0461	20	3	30	100	Weldon	20	-	-	-	-	●
		E90 - APKT10 - D20Z3W20 - L90	0084	20	3	40	90		20	-	-	-	-	●
		E90 - APKT10 - D22Z3W20 - L100	0544	22	3	30	100		20	-	-	-	-	●
		E90 - APKT10 - D25Z3W25 - L100	0545	25	3	30	100		25	-	-	-	-	●
		E90 - APKT10 - D25Z4W25 - L100	0546	25	4	30	100		25	-	-	-	-	●
		E90 - APKT10 - D32Z4W32 - L150 - WOC	0547	32	4	50	150		32	-	-	-	-	X
		F90 - APKT10 - D40Z4S16	0087	40	4	-	40	Shellmill	16	18	34	-	-	●
		F90 - APKT10 - D40Z5S16	0472	40	5	-	40		16	20	36	-	-	●
		F90 - APKT10 - D50Z6S22	0215	50	6	-	40		22	22	42	-	-	●
		F90 - APKT10 - D50Z7S22	0088	50	7	-	40		22	20	42	-	-	●
		F90 - APKT10 - D63Z7S22	0548	63	7	-	40		22	22	48	-	-	●
		F90 - APKT10 - D80Z8S27	0549	80	8	-	50		27	25	58	-	-	●
		F90 - APKT10 - D100Z9S32	0550	100	9	-	50	32	26	65	-	-	●	
		M90 - APKT10 - D16Z2M08	0551	16	2	-	30	Modular	M08	-	14.75	-	-	●
		M90 - APKT10 - D20Z3M10	0552	20	3	-	30		M10	-	18	-	-	●
		M90 - APKT10 - D25Z3M12	0553	25	3	-	35		M12	-	21	-	-	●
		M90 - APKT10 - D32Z4M16	0554	32	4	-	35		M16	-	29	-	-	●
		M90 - APKT10 - D40Z5M16	0555	40	5	-	43		M16	-	29	-	-	●
M90 - APKT10 - D42Z5M16	0556	42	5	-	43	M16	-		29	-	-	●		

* Clamping Torque (Nm) 1.2Nm

APKT10	Screw (Cutter D16~D20)	Screw (Cutter D20~)	Wrench
Description	TP072505	TP072506	TPWFTP07
EDP	1800016	18000013	18000001

Milling - Shoulder Milling - Cutter
Cutters for APKT

Cutting Angle : 90°
2 Corner Positive

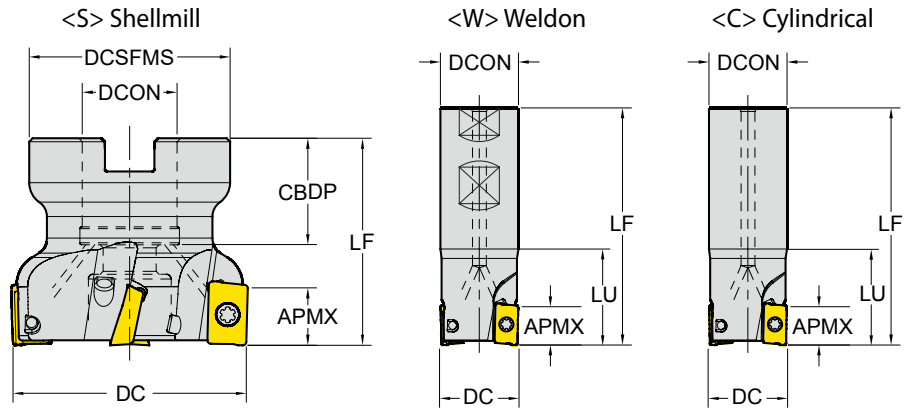

CICT : Number of Inserts
CBDP : Connection Bore Depth

□ : p. 151

Unit:mm

Series	APMX	Designation	EDP 1700..	DC	CICT	LU	LF	TYPE	DCON	CBDP	DCSFMS	PCD1	PCD2	☉	
APKT 1604	14.0	E90 - APKT16 - D25Z2C20 - L100	0091	25	2	-	100	Cylindrical	20	-	-	-	-	●	
		E90 - APKT16 - D25Z2C20 - L100 - WOC	0243	25	2	35	100		20	-	-	-	-	-	X
		E90 - APKT16 - D25Z2C25 - L250 - WOC	0557	25	2	100	250		25	-	-	-	-	-	X
		E90 - APKT16 - D32Z2C32 - L250 - WOC	0558	32	2	100	250		32	-	-	-	-	-	X
		E90 - APKT16 - D32Z3C25 - L110	0094	32	3	-	110	Cylindrical	25	-	-	-	-	-	●
		E90 - APKT16 - D32Z3C25 - L200	0559	32	3	40	200		25	-	-	-	-	-	●
		E90 - APKT16 - D32Z3C32 - L150 - WOC	0250	32	3	50	150		32	-	-	-	-	-	X
		E90 - APKT16 - D32Z3C32 - L250 - WOC	0560	32	3	100	250		32	-	-	-	-	-	X
		E90 - APKT16 - D40Z4C32 - L150 - WOC	0561	40	4	40	150	Weldon	32	-	-	-	-	-	X
		E90 - APKT16 - D25Z2W25 - L100	0562	25	2	35	100		25	-	-	-	-	-	●
		E90 - APKT16 - D25Z2W25 - L110	0092	25	2	-	110		25	-	-	-	-	-	●
		E90 - APKT16 - D28Z3W25 - L100	0563	28	3	40	100		25	-	-	-	-	-	●
		E90 - APKT16 - D30Z3W25 - L110	0564	30	3	40	110	Weldon	25	-	-	-	-	-	●
		E90 - APKT16 - D32Z3W25 - L110	0093	32	3	-	110		25	-	-	-	-	-	●
		E90 - APKT16 - D32Z3W32 - L110	0565	32	3	40	110		32	-	-	-	-	-	●
		E90 - APKT16 - D36Z3W32 - L110	0566	36	3	40	110		32	-	-	-	-	-	●
		F90 - APKT16 - D40Z4S16	0275	40	4	-	40	Shellmill	16	20	36	-	-	-	●
		F90 - APKT16 - D50Z5S22	0095	50	5	-	40		22	20	45	-	-	-	●

▶ NEXT PAGE

* Clamping Torque (Nm) 3.0Nm

APKT16	Screw	Wrench
Description	TP154008	TPWFTP15
EDP	18000006	18000003

Milling - Shoulder Milling - Cutter Cutters for APKT

Cutting Angle : 90°
2 Corner Positive

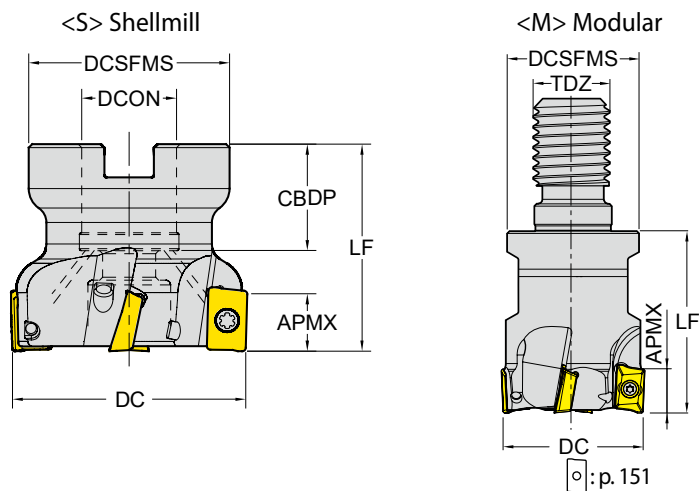

CICT : Number of Inserts
CBDP : Connection Bore Depth

Unit : mm

Series	APMX	Designation	EDP 1700..	DC	CICT	LU	LF	TYPE	DCON /TDZ	CBDP	DCSFMS	PCD1	PCD2	
APKT 1604	14.0	F90 - APKT16 - D52Z5S22	0567	52	5	-	40	Shellmill	22	22	42	-	-	●
		F90 - APKT16 - D63Z6S22	0096	63	6	-	40		22	20	50	-	-	●
		F90 - APKT16 - D80Z7S27	0097	80	7	-	50		27	23	56	-	-	●
		F90 - APKT16 - D100Z8S32	0181	100	8	-	50		32	26	65	-	-	●
		F90 - APKT16 - D125Z9S40 - WOC	0238	125	9	-	63		40	32	80	-	-	X
		F90 - APKT16 - D160Z10S40 - WOC	0568	160	10	-	63		40	32	110	66.7	-	X
		F90 - APKT16 - D200Z12S60 - WOC	0569	200	12	-	63		60	40	130	101.6	-	X
		M90 - APKT16 - D25Z2M12	0570	25	2	-	43	Modular	M12	-	21	-	-	●
		M90 - APKT16 - D32Z3M16	0571	32	3	-	43		M16	-	29	-	-	●
		M90 - APKT16 - D42Z4M16	0572	42	4	-	43		M16	-	29	-	-	●

* Clamping Torque (Nm) 3.0Nm

APKT16	Screw	Wrench
Description	TP154008	TPWFTP15
EDP	18000006	18000003

Milling - High Feed Milling - Cutter
Cutters for ENMX

Cutting Angle : 10°
4 Corner Negative

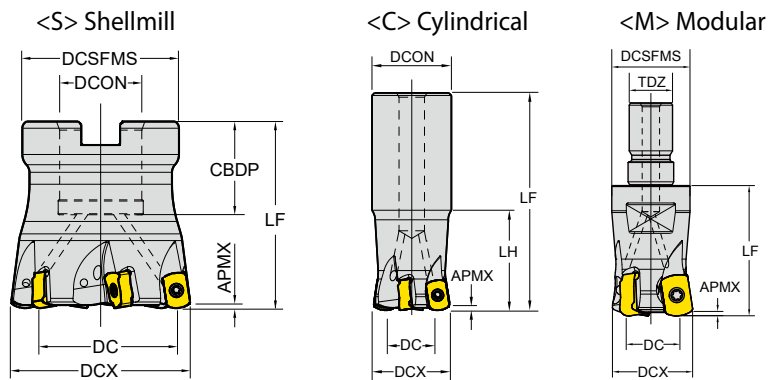

CICT : Number of Inserts
CDBP : Connection Bore Depth

□ : p. 153 Unit : mm

Series	APMX	Designation	EDP 1700..	DC	DCX	CICT	LF	Type	DCON /TDZ	LH	CDBP	DCSFMS	
ENMX 0604	0.9	EHF - ENMX06 - D16Z2C16 - L100	0644	9.0	16	2	100	Cylindrical	16	30	-	-	●
		EHF - ENMX06 - D16Z2C16 - L150	0645	9.0	16	2	150		16	50	-	-	●
		EHF - ENMX06 - D17Z2C16 - L100	0674	10.0	17	2	100		16	20	-	-	●
		EHF - ENMX06 - D17Z2C16 - L150	0473	10.0	17	2	150		16	20	-	-	●
	1	EHF - ENMX06 - D20Z3C20 - L130	0463	12.6	20	3	130	Cylindrical	20	50	-	-	●
			0646	12.6	20	3	160		20	80	-	-	●
		EHF - ENMX06 - D21Z3C20 - L150	0475	13.6	21	3	150		20	20	-	-	●
		EHF - ENMX06 - D21Z3C20 - L200	0476	13.6	21	3	200		20	20	-	-	●
		EHF - ENMX06 - D25Z4C25 - L140	0647	17.6	25	4	140		25	60	-	-	●
		EHF - ENMX06 - D25Z4C25 - L180	0464	17.6	25	4	180		25	80	-	-	●
		EHF - ENMX06 - D25Z4C25 - L250	0648	17.6	25	4	250		25	120	-	-	●
		EHF - ENMX06 - D26Z4C25 - L150	0479	18.6	26	4	150		25	30	-	-	●
		EHF - ENMX06 - D26Z4C25 - L200	0480	18.6	26	4	200		25	30	-	-	●
		EHF - ENMX06 - D32Z5C32 - L150	0649	24.6	32	5	150		32	70	-	-	●
EHF - ENMX06 - D32Z5C32 - L200	0465	24.6	32	5	200	32	100	-	-	●			
0.9	MHF - ENMX06 - D16Z2M08	0691	9.0	16	2	23	Modular	M08		-	13	●	
		0730	11.0	18	2	23		M08		-	13	●	
1	MHF - ENMX06 - D20Z3M10	0692	12.6	20	3	30	Modular	M10		-	18	●	
		0693	17.6	25	4	35		M12		-	21	●	
	MHF - ENMX06 - D32Z5M16	0694	24.6	32	5	42		M16		-	29	●	
	MHF - ENMX06 - D35Z5M16	0695	27.6	35	5	42		M16		-	29	●	
	MHF - ENMX06 - D40Z6M16	0732	32.6	40	6	42		M16		-	29	●	
	MHF - ENMX06 - D42Z6M16	0696	34.6	42	6	42		M16		-	29	●	
1	FHF - ENMX06 - D40Z6S16	0482	32.6	40	6	40	Shellmill	16		18	37	●	
		0471	42.6	50	6	50		22		25	42	●	

* Clamping Torque (Nm) 1.2Nm

ENMX06	Screw	Wrench	Handle	BIT
Description	TP082507-GS	TPWBTP08	DH-H4	DB-TP08
EDP	18000206	18000218	18000189	18000190

Milling - High Feed Milling - Cutter Cutters for ENMX

Cutting Angle : 10°
4 Corner Negative

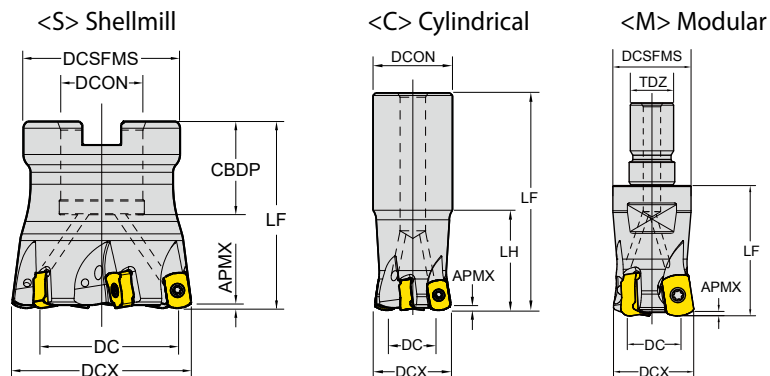

CICT : Number of Inserts
CBDP : Connection Bore Depth

□ : p. 153 Unit : mm

Series	APMX	Designation	EDP 1700..	DC	DCX	CICT	LF	Type	DCON /TDZ	LH	CBDP	DCSFMS	●
ENMX 0905	1.5	EHF - ENMX09 - D25Z2C25 - L150	0745	15	25	2	150	Cylindrical	25	70	-	-	●
		EHF - ENMX09 - D26Z2C25 - L200	0746	16	26	2	200		25	30	-	-	●
		EHF - ENMX09 - D26Z3C25 - L200	0747	16	26	3	200		25	30	-	-	●
		EHF - ENMX09 - D32Z3C32 - L160	0748	22	32	3	160		32	70	-	-	●
		EHF - ENMX09 - D33Z3C32 - L200	0749	23	33	3	200		32	30	-	-	●
		EHF - ENMX09 - D33Z4C32 - L200	0750	23	33	4	200		32	40	-	-	●
		EHF - ENMX09 - D40Z5C32 - L180	0751	30	40	5	180	32	40	-	-	●	
		FHF - ENMX09 - D50Z3S22	0820	40	50	3	50	Shellmill	22	-	20	42	●
		FHF - ENMX09 - D50Z4S22	0821	40	50	4	50		22	-	20	42	●
		FHF - ENMX09 - D50Z5S22	0752	40	50	5	50		22	-	20	42	●
		FHF - ENMX09 - D63Z4S22	0822	53	63	4	50		22	-	20	48	●
		FHF - ENMX09 - D63Z5S22	0823	53	63	5	50		22	-	20	48	●
		FHF - ENMX09 - D63Z6S22	0753	53	63	6	50		22	-	20	48	●
		FHF - ENMX09 - D63Z7S22	0754	53	63	7	50		22	-	20	48	●
		FHF - ENMX09 - D80Z8S27	0755	70	80	8	50		27	-	23	56	●
		FHF - ENMX09 - D100Z10S32	0824	90	100	10	63		32	-	26	78	●
FHF - ENMX09 - D125Z12S40	0825	115	125	12	63	40	-		28	89	●		

* Clamping Torque (Nm) 2.0Nm

ENMX09	Screw	Wrench	Handle	BIT
Description	TP093510-GS	TPWBTP09	DH-H4	DB-TP09
EDP	18000214	18000216	18000189	18000209

Milling - Face Milling - Cutter Cutters for OFER

Cutting Angle : 43°
8 Corner Positive

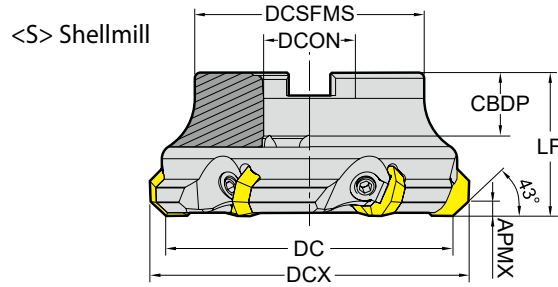

CICT : Number of Inserts
CBDP : Connection Bore Depth

□ : p. 156 Unit: mm

Series	APMX	Designation	EDP 1700..	DC	DCX	CICT	LF	TYPE	DCON	CBDP	DCSFMS	PCD1	PCD2	☉
OFER 0704	5.0	F43 - OFER07 - D63Z4S22 - WOC	0484	65	75	4	45	Shellmill	22	22	48	-	-	X
		F43 - OFER07 - D80Z5S27 - WOC	0485	82	92	5	50		27	25	58	-	-	X
		F43 - OFER07 - D100Z6S32 - WOC	0486	102	112	6	50		32	26	80	-	-	X
		F43 - OFER07 - D125Z8S40 - WOC	0487	127	137	8	63		40	32	85	-	-	X
		F43 - OFER07 - D160Z9S40 - WOC	0488	162	172	9	63		40	32	110	66.7	-	X

OFER07	Screw	Wrench	Wedge Clamp
Description	YAKV-15-M8x1x20	YAAL-05-4	YACK-11
EDP	18000086	18000062	18000068

Milling - Face Milling - Cutter Cutters for ODMT, ODMW

Cutting Angle : 43°
8 Corner Positive

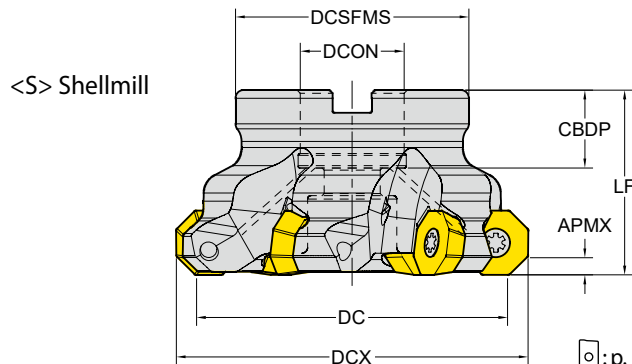

CICT : Number of Inserts
CBDP : Connection Bore Depth

□ : p. 155 Unit : mm

Series	APMX	Designation	EDP 1700..	DC	DCX	CICT	LF	TYPE	DCON	CBDP	DCSFMS	PCD1	PCD2	☉
ODMT ODMW 0605	3.5	F43 - ODMT06 - D63Z5S22	0001	63	73	5	40	Shellmill	22	20	50	-	-	●
		F43 - ODMT06 - D80Z6S27	0002	80	90	6	50		27	23	56	-	-	●
		F43 - ODMT06 - D100Z7S32	0003	100	110	7	50		32	26	78	-	-	●
		F43 - ODMT06 - D125Z8S40	0004	125	135	8	63		40	28	89	-	-	●

* Clamping Torque (Nm) 5.3Nm

ODMT06	Screw	Wrench
Description	TP205013	TPWFTP20
EDP	18000007	18000004

Milling - Face Milling - Cutter

Cutters for ONMU

Cutting Angle: 45°
16 Corner Negative

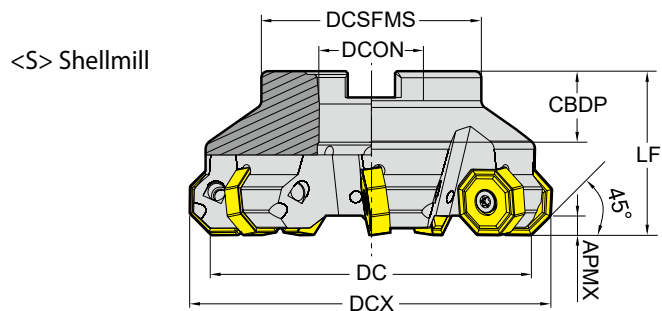

CICT : Number of Inserts
CBDP : Connection Bore Depth

□: p. 157 Unit: mm

Series	APMX	Designation	EDP 1700..	DC	DCX	CICT	LF	TYPE	DCON	CBDP	DCSFMS	PCD1	PCD2	☉
ONMU 0806	5.5	F45 - ONMU08 - D63Z5S22	0493	63	75	5	40	Shellmill	22	22	49	-	-	●
		F45 - ONMU08 - D80Z6S27	0494	80	92	6	50		27	25	58	-	-	●
		F45 - ONMU08 - D100Z7S32	0495	100	112	7	50		32	26	67	-	-	●
		F45 - ONMU08 - D125Z8S40 - WOC	0496	125	137	8	63		40	32	87	-	-	X
		F45 - ONMU08 - D160Z10S40 - WOC	0497	160	172	10	63		40	32	107	66.7	-	X
		F45 - ONMU08 - D200Z12S60 - WOC	0498	200	212	12	63		60	40	130	101.6	-	X
		F45 - ONMU08 - D315Z16S60 - WOC	0499	315	327	16	63		60	40	220	101.6	177.8	X

► ONHU is Available for Wiper Insert

* Clamping Torque (Nm) 5.3Nm

ONMU08	Screw	Wrench
Description	TP205013	TPWFTP20
EDP	18000007	18000004

Milling - Face Milling - Cutter
Cutters for PNMU

Cutting Angle : 36°
 10 Corner Negative

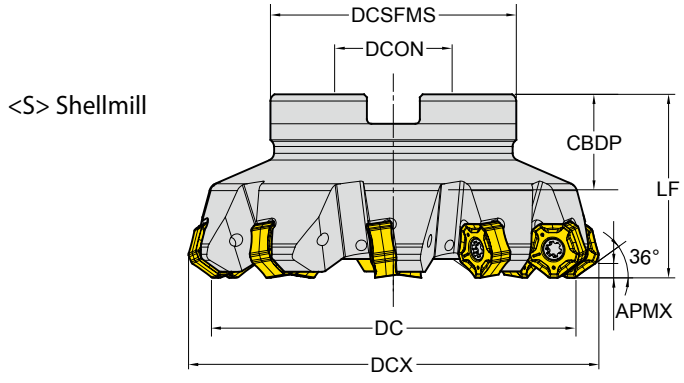

CICT : Number of Inserts
 CBDP : Connection Bore Depth

p. 158 Unit:mm

Series	APMX	Designation	EDP 1700..	DC	DCX	CICT	LF	TYPE	DCON	CBDP	DCSFMS	PCD1	PCD2	
PNMU 1206	4.0	F36 - PNMU12 - D50Z4S22	0774	50	63.6	4	40	Shellmill	22	20	42	-	-	●
		F36 - PNMU12 - D50Z5S22	0785	50	63.6	5	40		22	20	42	-	-	●
		F36 - PNMU12 - D63Z5S22	0775	63	76.6	5	40		22	20	48	-	-	●
		F36 - PNMU12 - D63Z6S22	0483	63	76.6	6	40		22	20	48	-	-	●
		F36 - PNMU12 - D80Z8S27	0466	80	93.6	8	50		27	23	58	-	-	●
		F36 - PNMU12 - D100Z10S32	0467	100	113.6	10	50		32	26	67	-	-	●
		F36 - PNMU12 - D125Z10S40	0786	125	138.6	10	63		40	29	89	-	-	●

* Clamping Torque (Nm) 3.0Nm

PNMU12	Screw	Wrench	Handle	BIT
Description	TP154008	TPWBTP15	DH-H4	DB-TP15
EDP	1800006	18000217	18000189	18000208

Milling - Profiling - Cutter





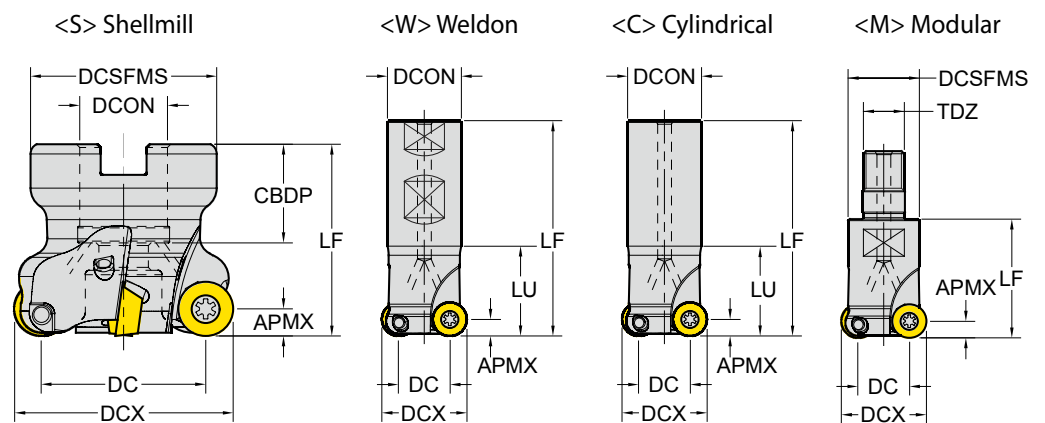









Cutters for RDKT, RDKW

Round Positive



CICT : Number of Inserts
 CBDP : Connection Bore Depth

 p. 159 Unit : mm

Series	APMX	Designation	EDP 1700..	DC	DCX	CICT	LU	LF	TYPE	DCON /TDZ	CBDP	DCSFMS	
RDKT RDKW 0802	4.0	E - RDKT08 - D16Z2C16 - L160	0005	8	16	2	-	160	Cylindrical	16	-	-	
		E - RDKT08 - D20Z2C20 - L180	0007	12	20	2	-	180		20	-	-	
		E - RDKT08 - D25Z3C20 - L180	0009	17	25	3	-	180		20	-	-	
		M - RDKT08 - D16Z2M08	0010	8	16	2	-	23	Modular	M08	-	13	
		M - RDKT08 - D20Z2M10	0011	12	20	2	-	30		M10	-	18	
		M - RDKT08 - D25Z3M12	0012	17	25	3	-	35		M12	-	21	
RDKT RDKW 10T3	5.0	E - RDKT10 - D20Z2C20 - L150 - WOC	0576	10	20	2	60	150	Cylindrical	20	-	-	X
		E - RDKT10 - D20Z2C20 - L180	0013	10	20	2	-	180		20	-	-	
		E - RDKT10 - D25Z2C25 - L150 - WOC	0299	15	25	2	60	150		25	-	-	X
		E - RDKT10 - D25Z2C25 - L180	0015	15	25	2	-	180		25	-	-	
		E - RDKT10 - D20Z2W20 - L150 - WOC	0577	10	20	2	60	150	Weldon	20	-	-	X
		E - RDKT10 - D25Z2W25 - L150 - WOC	0578	15	25	2	60	150		25	-	-	X
		E - RDKT10 - D32Z3W32 - L150 - WOC	0579	22	32	3	60	150	Shellmill	32	-	-	X
		F - RDKT10 - D40Z5S16	0019	30	40	5	-	40		16	18	34	
		F - RDKT10 - D50Z5S22	0580	40	50	5	-	50		22	22	42	
		F - RDKT10 - D50Z6S22	0020	40	50	6	-	50		22	22	42	
		F - RDKT10 - D63Z6S22	0581	53	63	6	-	50	22	22	48		
		M - RDKT10 - D20Z2M10	0017	10	20	2	-	30	Modular	M10	-	18	
M - RDKT10 - D25Z3M12	0018	15	25	3	-	35	M12	-		21			

* Clamping Torque (Nm) 1.2Nm

RDKT08	Screw	Wrench
Description	TP082505	TPWFTP08
EDP	18000008	18000002

* Clamping Torque (Nm) 3.0Nm

RDKT10	Screw	Wrench
Description	TP154008RD	TPWFTP15
EDP	18000017	18000003

Milling - Profiling - Cutter
Cutters for RDKT, RDKW

TURNING
 PARTING & GROOVING
 MILLING
 DRILLING
 TECHNICAL INFORMATION

Round Positive

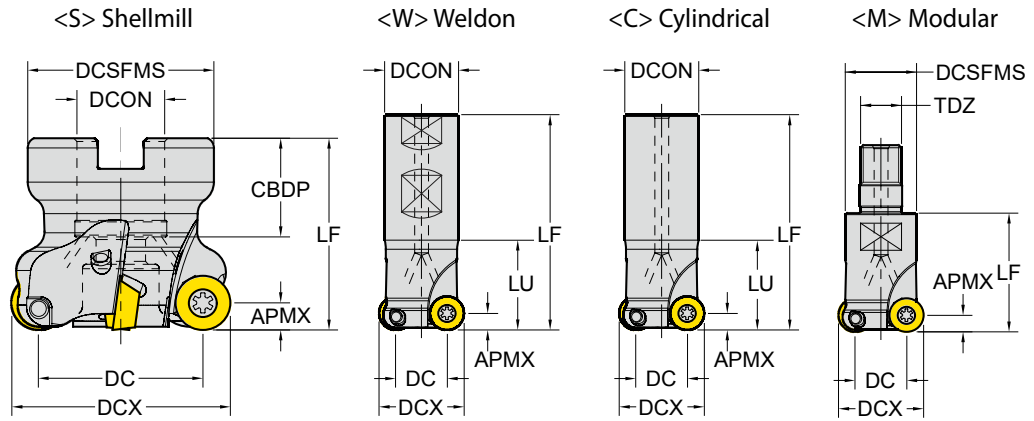

CICT : Number of Inserts
 CDBP : Connection Bore Depth

p. 159 Unit : mm

Series	APMX	Designation	EDP 1700..	DC	DCX	CICT	LU	LF	TYPE	DCON /TDZ	CDBP	DCSFMS	Drop
RDKT RDKW 1204	6.0	E - RDKT12 - D25Z2C25 - L180	0021	13	25	2	80	180	Cylindrical	25	-	-	●
		E - RDKT12 - D32Z2C32 - L200	0023	20	32	2	60	200		32	-	-	●
		E - RDKT12 - D32Z3C32 - L160	0024	20	32	3	60	160		32	-	-	●
		E - RDKT12 - D32Z3C32 - L160 - WOC	0582	20	32	3	70	160		32	-	-	X
		E - RDKT12 - D33Z3C32 - L160 - WOC	0583	21	33	3	70	160		32	-	-	X
		E - RDKT12 - D32Z3W32 - L160 - WOC	0584	20	32	3	50	160	Weldon	32	-	-	X
		F - RDKT12 - D40Z4S16	0028	28	40	4	-	40	Shellmill	16	18	32	●
		F - RDKT12 - D50Z5S22	0029	38	50	5	-	50		22	20	40	●
		F - RDKT12 - D52Z5S22	0585	40	52	5	-	50		22	22	42	●
		F - RDKT12 - D63Z6S22	0030	51	63	6	-	50		22	20	48	●
		F - RDKT12 - D80Z7S27	0586	68	80	7	-	50		27	25	58	●
		F - RDKT12 - D100Z7S32	0587	88	100	7	-	50		32	26	65	●
		F - RDKT12 - D100Z8S32	0588	88	100	8	-	50	32	26	65	●	
		M - RDKT12 - D25Z2M12	0026	13	25	2	-	35	Modular	M12	-	21	●
M - RDKT12 - D32Z3M16	0027	20	32	3	-	42	M16	-		29	●		
M - RDKT12 - D42Z4M16	0589	30	42	4	-	43	M16	-		29	●		

* Clamping Torque (Nm) 3.0Nm

RDKT12	Screw	Wrench	Wedge Clamp
Description	TP154009	TPWFTP15	MTCA - 130813P
EDP	18000010	18000003	18000037

Milling - High Feed Milling - Cutter Cutters for SDMT, SDMW

Cutting Angle : 10°
4 Corner Positive

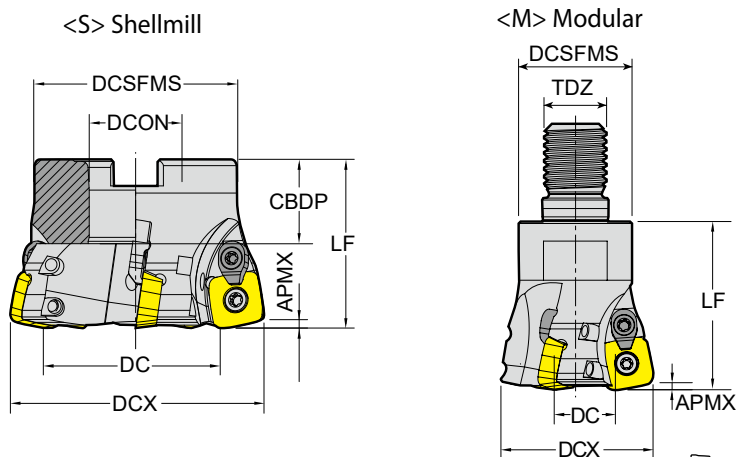

CICT : Number of Inserts
CDBP : Connection Bore Depth

☐ : p. 163 Unit : mm

Series	APMX	Designation	EDP 1700..	DC	DCX	CICT	Lf	TYPE	DCON /TDZ	CDBP	DCSFMS	☉
SDMT SDMW 1204	1.8	FHF - SDMW12 - D50Z4S22	0604	32.4	50	4	40	Shellmill	22	22	42	●
		FHF - SDMW12 - D63Z5S22	0605	45.4	63	5	40		22	22	48	●
		FHF - SDMW12 - D80Z6S27	0606	62.4	80	6	50		27	25	58	●
		FHF - SDMW12 - D100Z8S32	0607	82.4	100	8	50		32	26	65	●
		MHF - SDMW12 - D32Z2M16	0608	14.4	32	2	43	Modular	M16	-	29	●
		MHF - SDMW12 - D40Z3M16	0609	22.4	40	3	43		M16	-	29	●

* Clamping Torque (Nm) 3.0Nm

SDMT12	Screw	Wrench	Handle	Wedge Clamp
Description	Y4015-M4x11	Y80-T15	18000167	YACK-15
EDP	18000119	18000167	-	18000069

Milling - Face Milling - Cutter
Cutters for SEGT, SEKT

Cutting Angle : 45°
 4 Corner Positive

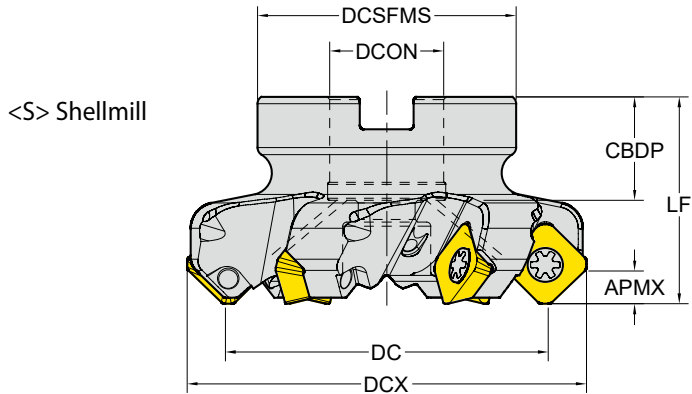

CICT : Number of Inserts
 CDBP : Connection Bore Depth

p. 165/164 Unit:mm

Series	APMX	Designation	EDP 1700..	DC	DCX	CICT	LF	TYPE	DCON	CBDP	DCSFMS	PCD1	PCD2	⦿
SEGT SEKT 12T3	6.0	F45 - SE12T3 - D50Z4S22	0500	50	64	4	40	Shellmill	22	22	48	-	-	●
		F45 - SE12T3 - D63Z5S22	0501	63	77	5	40		22	22	48	-	-	●
		F45 - SE12T3 - D80Z6S27	0502	80	94	6	50		27	25	58	-	-	●
		F45 - SE12T3 - D100Z7S32	0503	100	114	7	50		32	26	65	-	-	●
		F45 - SE12T3 - D125Z8S40 - WOC	0504	125	139	8	63		40	32	85	-	-	X
		F45 - SE12T3 - D160Z10S40 - WOC	0505	160	174	10	63		40	32	110	66.7	-	X
SEGT SEKT 1204	6.0	F45 - SEKT12 - D40Z4S16	0031	40	54	4	40	Shellmill	16	18	32	-	-	●
		F45 - SEKT12 - D50Z5S22	0032	50	64	5	40		22	20	48	-	-	●
		F45 - SEKT12 - D63Z4S22	0033	63	77	4	40		22	20	50	-	-	●
		F45 - SEKT12 - D63Z6S22	0034	63	77	6	40		22	20	50	-	-	●
		F45 - SEKT12 - D80Z4S27	0035	80	94	4	50		27	22	56	-	-	●
		F45 - SEKT12 - D80Z7S27	0036	80	94	7	50		27	22	56	-	-	●
		F45 - SEKT12 - D100Z8S32	0037	100	114	8	50		32	25	78	-	-	●
		F45 - SEKT12 - D125Z10S40	0038	125	139	10	63		40	29	90	-	-	●
		F45 - SEKT12 - D160Z12S40	0039	160	174	12	63		40	30	114	-	-	X

* Clamping Torque (Nm) 2.4Nm

SEKT12T3	Screw	Wrench
Description	Y4015-M3.5x11	Y80-T15
EDP	18000118	18000167

SEKT1204	Screw	Wrench
Description	TP204510	TPWFTP20
EDP	18000011	18000004

Milling - Face Milling - Cutter

Cutters for SPCN, SPKN, SPKR

Cutting Angle : 75°
4 Corner Positive ISO

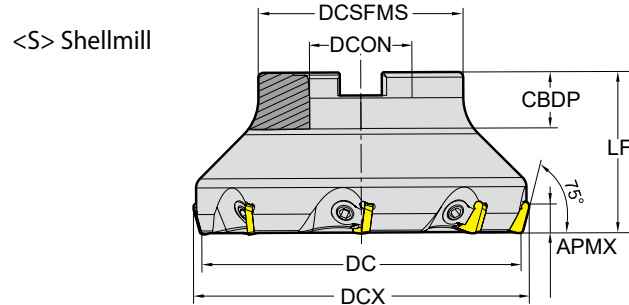

CICT : Number of Inserts
CDBP : Connection Bore Depth

□ : p. 169 Unit: mm

Series	APMX	Designation	EDP 1700..	DC	DCX	CICT	LF	TYPE	DCON	CBDP	DCSFMS	PCD1	PCD2	☰
SPCN SPKN SPKR 1203	8.0	F75 - SPKN12 - D50Z4S22 - WOC	0611	50	56	4	42	Shellmill	22	22	42	-	-	X
		F75 - SPKN12 - D63Z5S22 - WOC	0612	63	69	5	40		22	22	48	-	-	X
		F75 - SPKN12 - D80Z6S27 - WOC	0613	80	86	6	50		27	25	58	-	-	X
		F75 - SPKN12 - D100Z7S32 - WOC	0614	100	106	7	50		32	26	65	-	-	X
		F75 - SPKN12 - D125Z8S40 - WOC	0615	125	131	8	63		40	32	80	-	-	X
		F75 - SPKN12 - D160Z9S40 - WOC	0616	160	166	9	63		40	32	110	66.7	-	X
		F75 - SPKN12 - D200Z12S60 - WOC	0617	200	206	12	63		60	40	130	101.6	-	X

SPKN1203	Screw	Wrench	Wedge Clamp
Description	YAKV-22-M8x1x14	YAAL-05-4	YACK-10
EDP	18000089	18000062	18000067
Description	YAKV-13-M8x1x16	-	-
EDP	18000084	-	-

Milling - Face Milling - Cutter
Cutters for SNMX

Cutting Angle : 45°
 8 Corner Negative

TURNING

PARTING & GROOVING

MILLING

DRILLING

TECHNICAL INFORMATION

<S> Shellmill

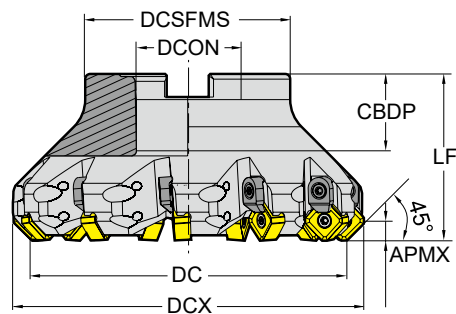

CICT : Number of Inserts
 CBDP : Connection Bore Depth

□: p. 168

Unit:mm

Series	APMX	Designation	EDP 1700..	DC	DCX	CICT	LF	TYPE	DCON	CBDP	DCSFMS	PCD1	PCD2	⦿
SNMX 1206 ANN	6.0	F45 - SNMX12 - D50Z4S22	0506	50	63	4	42	Shellmill	22	22	42	-	-	●
		F45 - SNMX12 - D50Z5S22	0507	50	63	5	42		22	22	42	-	-	●
		F45 - SNMX12 - D63Z6S22	0508	63	76	6	42		22	22	48	-	-	●
		F45 - SNMX12 - D63Z7S22	0509	63	76	7	42		22	22	48	-	-	●
		F45 - SNMX12 - D80Z7S27	0510	80	93	7	52		27	25	58	-	-	●
		F45 - SNMX12 - D80Z8S27	0511	80	93	8	52		27	25	58	-	-	●
		F45 - SNMX12 - D100Z10S32	0512	100	113	10	52		32	26	67	-	-	●
		F45 - SNMX12 - D100Z8S32	0513	100	113	8	52		32	26	67	-	-	●
		F45 - SNMX12 - D125Z11S40 - WOC	0514	125	138	11	65		40	32	80	-	-	X
		F45 - SNMX12 - D160Z12S40 - WOC	0515	160	173	12	65		40	32	110	66.7	-	X
F45 - SNMX12 - D200Z14S60 - WOC	0516	200	213	14	65	60	40	130	101.6	-	X			

* Clamping Torque (Nm) 3.0Nm

SNMX12	Screw	Wrench	Wedge Clamp
Descritpion	Y4015-M4x11	Y80-T15	Y4015-M4x11
EDP	18000119	18000167	18000119

Milling - Shoulder Milling - Cutter

Cutters for TPCN, TPKN, TPKR

Cutting Angle : 90°
3 Corner Positive ISO

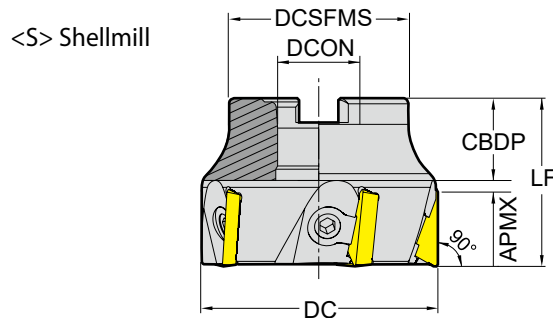

CICT : Number of Inserts
CBDP : Connection Bore Depth

 p. 173

Unit:mm

Series	APMX	Designation	EDP 1700..	DC	CICT	LU	LF	TYPE	DCON	CBDP	DCSFMS	PCD1	PCD2	
TPCN TPKN TPKR 1603	12.0	F90 - TPKN16 - D50Z4S22 - WOC	0618	50	4	-	40	Shellmill	22	22	42	-	-	X
		F90 - TPKN16 - D63Z6S22 - WOC	0619	63	6	-	45		22	22	48	-	-	X
		F90 - TPKN16 - D80Z7S27 - WOC	0620	80	7	-	50		27	25	58	-	-	X
		F90 - TPKN16 - D125Z8S40 - WOC	0621	125	8	-	63		40	32	80	-	-	X
TPCN TPKN TPKR 2204	18.0	F90 - TPKN22 - D63Z5S22 - WOC	0622	63	5	-	45	Shellmill	22	22	48	-	-	X
		F90 - TPKN22 - D80Z6S27 - WOC	0623	80	6	-	50		27	25	58	-	-	X
		F90 - TPKN22 - D100Z7S32 - WOC	0624	100	7	-	50		32	26	65	-	-	X
		F90 - TPKN22 - D125Z8S40 - WOC	0625	125	8	-	63		40	32	80	-	-	X
		F90 - TPKN22 - D160Z9S40 - WOC	0626	160	9	-	63		40	32	110	66.7	-	X
		F90 - TPKN22 - D200Z12S60 - WOC	0627	200	12	-	63		60	40	130	101.6	-	X
		F90 - TPKN22 - D250Z15S60 - WOC	0628	250	15	-	63		60	40	160	101.6	-	X
		F90 - TPKN22 - D315Z18S60 - WOC	0629	315	18	-	63		60	40	220	101.6	177.8	X

TPKN16	Screw	Wrench	Wedge Clamp
Description	YAKV-13-M8x1x16	YAAL-05-4	YACK-10
EDP	18000084	18000062	18000067

TPKN22	Screw	Wrench	Wedge Clamp
Description	YAKV-14-M8x1x18	YAAL-05-4	YACK-11
EDP	18000085	18000062	18000068

Milling - Shoulder Milling - Cutter
Cutters for TPKT

Cutting Angle : 90°
3 Corner Positive

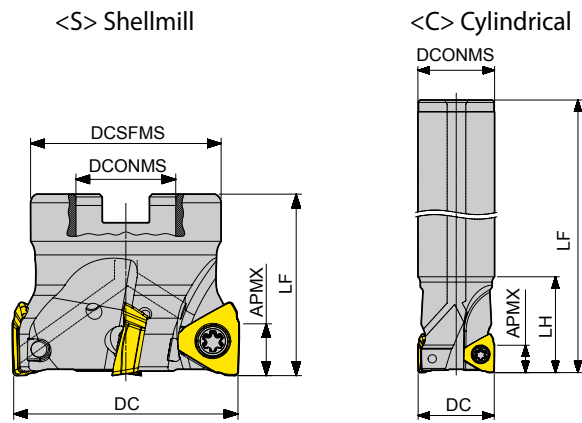

CICT : Number of Inserts
CBDP : Connection Bore Depth

□: p. 172

Unit : mm

Series	APMX	Designation	EDP 1700..	DC	CICT	LF	TYPE	DCON /TDZ	LH	CBDP	DCSFMS	
NEW TPKT 1104	7.0	E90 - TP11 - D20Z2W20 - L90	0995	20	2	90	Cylindrical	20	40	-	-	●
		E90 - TP11 - D20Z2C20 - L170	1037	20	2	170		20	40	-	-	●
		E90 - TP11 - D21Z2C20 - L150	1038	21	2	150		20	40	-	-	●
		E90 - TP11 - D21Z2C20 - L200	1039	21	2	200		20	40	-	-	●
		E90 - TP11 - D25Z3W25 - L100	1040	25	3	100		25	40	-	-	●
		E90 - TP11 - D25Z3C25 - L200	1026	25	3	200		25	60	-	-	●
		E90 - TP11 - D26Z2C25 - L200	1041	26	2	200		25	40	-	-	●
		E90 - TP11 - D26Z2C25 - L250	1042	26	2	200		25	40	-	-	●
		E90 - TP11 - D26Z3C25 - L150	1043	26	3	150		25	40	-	-	●
		E90 - TP11 - D26Z3C25 - L200	1044	26	3	200		25	40	-	-	●
		E90 - TP11 - D32Z3C32 - L230	1045	32	3	230		32	60	-	-	●
		E90 - TP11 - D32Z4W32 - L110	1046	32	4	110		32	40	-	-	●
		E90 - TP11 - D33Z3C32 - L200	1047	33	3	200		32	40	-	-	●
		E90 - TP11 - D40Z4C32 - L200	1048	40	4	200		32	60	-	-	●
		E90 - TP11 - D40Z5W32 - L115	1049	40	5	115		32	40	-	-	●
F90 - TP11 - D40Z5S16	1050	40	5	40	Shellmill	16	-	20	38	●		
F90 - TP11 - D50Z6S22	1051	50	6	40		22	-	20	42	●		
F90 - TP11 - D63Z7S22	1052	63	7	40		22	-	20	48	●		
F90 - TP11 - D63Z8S22	1053	63	8	40		22	-	20	48	●		

* Clamping Torque (Nm) 1.2Nm

TPKT1104 (D20, D21)	Screw	Wrench	Handle	BIT
Description	TP082562-GS	TPWBTP08	DH-H4	DB-TP08
EDP	18000265	18000218	18000189	18000190

TPKT1104 (over D25)	Screw	Wrench	Handle	BIT
Description	TP082506-GS	TPWBTP08	DH-H4	DB-TP08
EDP	18000259	18000218	18000189	18000190

Milling - Shoulder Milling - Cutter Cutters for TPKT

Cutting Angle : 90°
3 Corner Positive

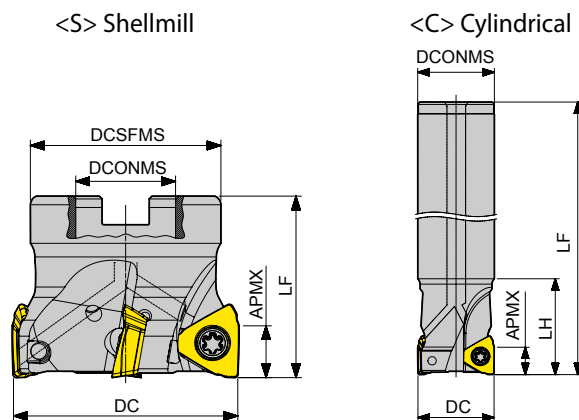

CICT : Number of Inserts
CBDP : Connection Bore Depth

□ : p. 172

Unit : mm

Series	APMX	Designation	EDP 1700..	DC	CICT	LF	TYPE	DCON /TDZ	LH	CBDP	DCSFMS	🔹
TPKT 1605 11.0	NEW	E90 - TP16 - D32Z2C32 - L150	0941	32	2	150	Cylindrical	32	40	-	-	●
		E90 - TP16 - D32Z2C32 - L250	0942	32	2	250		32	80	-	-	●
		E90 - TP16 - D33Z2C32 - L200	0929	33	2	200		32	40	-	-	●
		E90 - TP16 - D33Z2C32 - L250	1010	33	2	250		32	40	-	-	●
		E90 - TP16 - D40Z3W32 - L110	0944	40	3	110		32	40	-	-	●
		E90 - TP16 - D40Z4C32 - L200	0945	40	4	200		32	40	-	-	●
		F90 - TP16 - D50Z4S22	0931	50	4	40	Shellmill	22	-	29	42	●
		F90 - TP16 - D63Z5S22	0932	63	5	40		22	-	29	48	●
		F90 - TP16 - D63Z6S22	0947	63	6	40		22	-	29	48	●
		F90 - TP16 - D80Z6S27	0948	80	6	50		27	-	39	56	●
		F90 - TP16 - D80Z7S27	0949	80	7	50		27	-	39	56	●
		F90 - TP16 - D100Z8S32	0950	100	8	50		32	-	39	67	●
		F90 - TP16 - D125Z10S40	0951	125	10	63		40	-	52	89	●
		F90 - TP16 - D125Z12S40	0952	125	12	63		40	-	52	89	●
		F90 - TP16 - D160Z11S40	0953	160	11	63		40	-	52	110	X
		F90 - TP16 - D200Z11S60	0955	200	11	63		60	-	52	160	X

* Clamping Torque (Nm) 5.3Nm

TPKT1605	Screw	Wrench	Handle	BIT
Description	TP2045105	TPWBTP20	DH-H6	DB-TP20
EDP	18000264	18000256	18000210	18000257

Milling - High Feed Milling - Cutter
Cutters for WNEX

Cutting Angle : 90°
3 Corner Positive

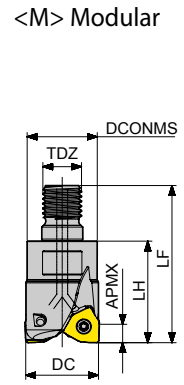
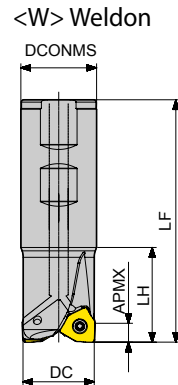
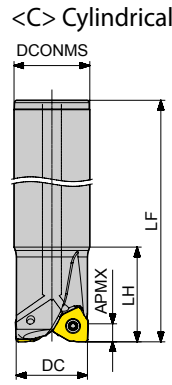
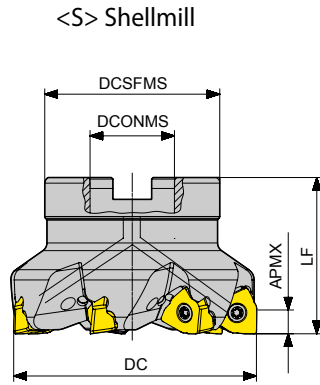

CICT : Number of Inserts
CBDP : Connection Bore Depth

□: p.175

Unit : mm

Series	APMX	Designation	EDP 1700..	DC	CICT	LF	TYPE	DCON /TDZ	LH	CBDP	DCSFMS	●	
WNEX 0806	7.0	E90 - WN08 - D32Z2W32 - L120	0969	32	2	120	Weldon	32	40	-	-	●	
		E90 - WN08 - D40Z3W32 - L120	0972	40	3	120		32	40	-	-	●	
		E90 - WN08 - D40Z4W32 - L120	0973	40	4	120		32	40	-	-	●	
		E90 - WN08 - D50Z4W32 - L120	0974	50	4	120		32	40	-	-	●	
		E90 - WN08 - D50Z5W32 - L120	0990	50	5	120		32	40	-	-	●	
		E90 - WN08 - D32Z2C32 - L120	0991	32	2	120	Cylindrical	32	40	-	-	●	
		E90 - WN08 - D32Z2C32 - L200	0872	32	2	200		32	60	-	-	●	
		E90 - WN08 - D33Z2C32 - L200	0873	33	2	200		32	40	-	-	●	
		E90 - WN08 - D40Z3C32 - L120	0994	40	3	120		32	40	-	-	●	
		E90 - WN08 - D40Z3C32 - L200	0874	40	3	200		32	40	-	-	●	
		E90 - WN08 - D40Z4C32 - L120	0996	40	4	120		32	40	-	-	●	
		E90 - WN08 - D50Z4C32 - L120	0997	50	4	120		32	40	-	-	●	
		E90 - WN08 - D50Z5C32 - L120	0998	50	5	120		32	40	-	-	●	
		F90 - WN08 - D50Z4S22	0875	50	4	40		Shellmill	22	-	20	44	●
		F90 - WN08 - D50Z5S22	0976	50	5	40			22	-	20	44	●
		F90 - WN08 - D63Z5S22	0876	63	5	40	22		-	20	48	●	
		F90 - WN08 - D63Z6S22	0977	63	6	40	22		-	20	48	●	
		F90 - WN08 - D80Z4S27	0999	80	4	50	27		-	20	56	●	
		F90 - WN08 - D80Z6S25.4	1000	80	6	50	25.4		-	26.64	56	●	
		F90 - WN08 - D80Z7S27	0878	80	7	50	27		-	23	56	●	
F90 - WN08 - D80Z7S25.4	0877	80	7	50	25.4	-	26.64		56	●			
F90 - WN08 - D80Z9S27	0978	80	9	50	27	-	23		56	●			
F90 - WN08 - D100Z8S31.75 - WOC	1002	100	8	50	31.75	-	32		67	X			
F90 - WN08 - D100Z9S32	0979	100	9	50	32	-	26	67	●				
F90 - WN08 - D100Z11S32	0980	100	11	50	32	-	26	67	●				
F90 - WN08 - D125Z10S38.1 - WOC	1003	125	10	63	38.1	-	38	85	X				
F90 - WN08 - D125Z11S40	0981	125	11	63	40	-	29	85	●				
F90 - WN08 - D125Z14S40	0982	125	14	63	40	-	29	85	●				
M90 - WN08 - D32Z2M16	1004	32	2	65	Modular	M16	42	-	29	●			
M90 - WN08 - D40Z3M16	1005	40	3	65		M16	42	-	29	●			
M90 - WN08 - D40Z4M16	0984	40	4	65		M16	42	-	29	●			

* Clamping Torque (Nm) 3.0Nm

WNEX0806	Screw	Wrench	Handle	BIT
Description	TP154011-GS	TPWBTP15	DH-H4	DB-TP15
EDP	18000251	18000217	18000189	18000208

Milling - Modular Shank

Modular Shanks

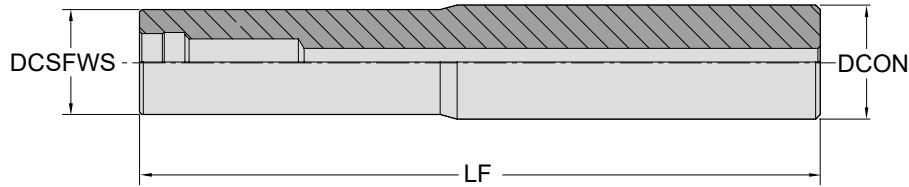

Unit:mm

Series	Designation	EDP 1700..	DCSFWS	LF	TYPE	DCON	
M08	EM - M08 - D13C16 - L100	0634	13	100	Cylindrical	16	●
	EM - M08 - D15C16 - L130	0635	15	130		16	●
M10	EM - M10 - D18C20 - L130	0636	18	130	Cylindrical	20	●
M12	EM - M12 - D23C25 - L150	0637	23	150	Cylindrical	25	●
	EM - M12 - D23C25 - L200	0638	23	200		25	●
	EM - M12 - D23C25 - L250	0639	23	250		25	●
M16	EM - M16 - D30C32 - L150	0640	30	150	Cylindrical	32	●
	EM - M16 - D30C32 - L200	0641	30	200		32	●
	EM - M16 - D30C32 - L250	0642	30	250		32	●
	EM - M16 - D30C32 - L300	0643	30	300		32	●

Mounting Bolt

DCON	Description	EDP
Φ16	YHBM08-L20	18000224
Φ16 HF	YHBM08-L25	18000238
Φ22	YHBM10-L25	18000239
Φ22 HF	YHBM10-L30	18000240
Φ25.4 (Metric O.D)	YHBM12-L30	18000241
Φ27	YHBM12-L30	18000241
Φ31.75 (Metric O.D)	YMBM16-L42	18000242
Φ32	YMBM16-L42	18000242
Φ32 HF	YMBM16-L50	18000258
Φ38.1 (Metric O.D)	YMBM20-L54	18000243
Φ40	YMBM20-L54	18000243
Φ0.5" (Φ12.7)	YHBU250-L25.4	18000244
Φ0.75" (Φ19.05)	YHBU375-L25.4	18000245
Φ0.75" (Φ19.05) HF	YHBU375-L31.75	18000246
Φ1.0" (Φ25.4)	YHBU500-L38.1	18000247
Φ1.25" (Φ31.75)	YMBU625-L52	18000248
Φ1.5" (Φ38.1)	YMBU750-L60	18000249
Φ2.0" (Φ50.8)	YMBU1000-L70	18000250



DRILLING

Drilling Overview

Drill Holder

X-Drill Inserts (SYM_X)

Square Drill Inserts (SPM_X)

Triagonal Drilling Inserts (WCM_X)

Drilling Overview

Drilling Grades

Drilling Grades		P Steel					M Stainless steel					K Cast iron				
		P05	P15	P25	P35	P45	M05	M15	M25	M35	M45	K05	K15	K25	K35	K45
PVD	YG713			713					713					713		
	YG602			602					602					602		
	YG613				613					613						

YG713 P15 - P30 M15 - M30 K15 - K30 H20 - H30	PVD - TiAlN 	Drilling Grade for General Steel Application <ul style="list-style-type: none"> Multi-layer TiAlN structure realizes stronger crater and flank wear resistance Fine-grained carbide and balanced substrate
YG602 P20 - P35 M20 - M40 K20 - K40 S15 - S25	PVD - TiAlN 	Universal grade for General Drilling Application <ul style="list-style-type: none"> Ultra Dense PVD Coating with optimal thermal resistance & strength Sub-Micron substrate designed for demanding application
YG613 P30 - P50 M30 - M50	PVD - TiAlN 	Drilling Grade for Stainless Steel Application <ul style="list-style-type: none"> New coating layer with lubrication preventing built-up edge on ultra fine grain substrate with high toughness. The toughest substrate provides excellent cutting performance in stainless steel

Universal Drilling Inserts

	4 Corner	SYM ^{NEW} X Series	SYMX	05, 06, 07, 08
	4 Corner	SPMX Series	SPMX	05, 06, 07, 09, 11, 14
	ISO 3 Corner	WCMX Series	WCMX	03, 04, 05, 06, 08

Drilling Chipbreakers

P	M	K		
	M		-ST	 • Sharp Geometry • Sticky Material, Stainless Steel
P	M	K	General Inserts (No Description)	 • First Choice for General Application

Drilling - Inserts

X-Drill Inserts (SYMX)

Recommended Cutting Conditions : p.223

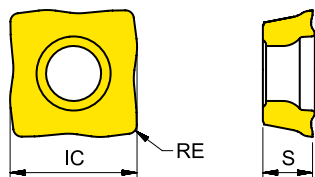

Series	IC	S
SYMX 0502	4.97	2.35
SYMX 0602	5.99	2.35
SYMX 07T2	7.01	2.80
SYMX 0803	8.30	3.20

EDP 3200..

SYMX	Designation	RE (mm)	Fn (mm/rev.)	P25	P20	P40
				M25	M20	
				K30	K20	M40
				YG602	YG713	YG613
	SYMX 050204	0.4	0.06~0.12		● 0097	● 0098
	SYMX 060204	0.4	0.06~0.12		● 0093	● 0095
	SYMX 07T206	0.6	0.06~0.12		● 0099	● 0100
	SYMX 080306	0.6	0.08~0.20		● 0101	● 0102

NEW
SYMX
General



● : Stock item ○ : Order made item

TURNING

PARTING & GROOVING

MILLING

DRILLING

TECHNICAL INFORMATION

Drilling - Inserts

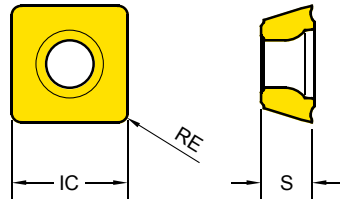

Square Drill Inserts (SPMX)

Recommended Cutting Conditions : p.223



Series	IC	S
SPMX 0502	5.00	2.38
SPMX 0602	6.00	2.41
SPMX 07T3	7.94	3.97
SPMX 0904	9.80	4.30
SPMX 1104	11.50	4.80
SPMX 1405	14.30	5.20

EDP 3200..

SPMX	Designation	RE (mm)	Fn (mm/rev.)	P25	P20	P40
				M25	M20	M40
				K30	K20	M40
SPMX General 				YG602	YG713	YG613
	SPMX 050204	0.4	0.07~0.14	● 0005	● 0062	● 0077
	SPMX 060204	0.4	0.08~0.14	● 0006	● 0063	● 0078
	SPMX 07T308	0.8	0.08~0.16	● 0007	● 0064	● 0061
	SPMX 090408	0.8	0.08~0.16	● 0008	● 0065	● 0079
	SPMX 110408	0.8	0.10~0.18	● 0009	● 0066	● 0080
	SPMX 140512	1.2	0.10~0.20	● 0010	● 0067	
-ST Stainless Steel 	SPMX 050204 - ST	0.4	0.03~0.10	● 0011		● 0070
	SPMX 060204 - ST	0.4	0.04~0.11	● 0012		● 0071
	SPMX 07T308 - ST	0.8	0.04~0.11	● 0013		● 0068
	SPMX 090408 - ST	0.8	0.05~0.12	● 0014		● 0072
	SPMX 110408 - ST	0.8	0.05~0.12			● 0073
	SPMX 140512 - ST	1.2	0.05~0.16			● 0074

● : Stock item ○ : Order made item

Drilling - Inserts

Triagonal Drill Inserts (WCMX)

Recommended Cutting Conditions : p.223

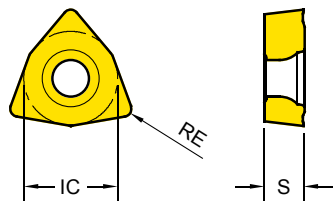

Series	IC	S
WCMX 0302	5.56	2.38
WCMX 0402	6.35	2.38
WCMX 0503	7.94	3.18
WCMX 06T3	9.53	3.97
WCMX 0804	12.70	4.76

EDP 3200..

WCMX	Designation	RE (mm)	Fn (mm/rev.)	P25	P20	P40
				M25	M20	M40
				K30	K20	M40
				YG602	YG713	YG613
	WCMX 030208	0.8	0.05~0.12	● 0031	● 0086	
	WCMX 040208	0.8	0.05~0.12	● 0003	● 0087	
	WCMX 050308	0.8	0.06~0.14	● 0001	● 0088	
	WCMX 06T308	0.8	0.08~0.14	● 0002	● 0089	
	WCMX 080412	1.2	0.08~0.14	● 0004	● 0090	● 0091

WCMX
General



● : Stock item ○ : Order made item

TURNING

PARTING & GROOVING

MILLING

DRILLING

TECHNICAL INFORMATION

Drilling - Drill Holder

X-Drill Holder (SYM05) (DC 14~16)

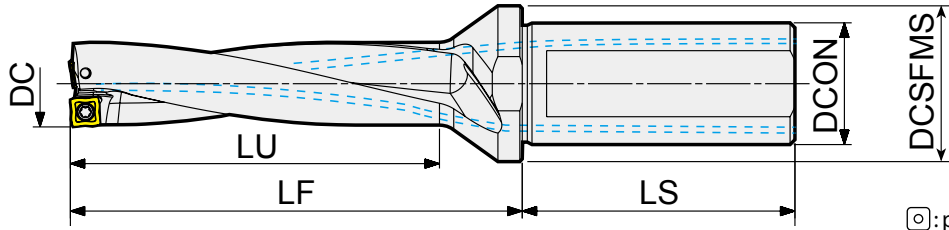

☐: p.200

Unit:mm

Series	DC	LU	Designation	EDP 3700..	LF	OAL	DCON	DCSFMS	LS
14	28		YGSY2 - 140S20 - 05	1019	46	96.0	20	25	50
	42		YGSY3 - 140S20 - 05	1031	60	110.0			
	56		YGSY4 - 140S20 - 05	1043	74	124.0			
	70		YGSY5 - 140S20 - 05	1055	88	141.5			
	30		YGSY2 - 150S20 - 05	1020	49	99.0			
15	45		YGSY3 - 150S20 - 05	1032	64	114.0			
	60		YGSY4 - 150S20 - 05	1044	79	129.0			
	75		YGSY5 - 150S20 - 05	1056	94	146.5			
16	32		YGSY2 - 160S25 - 05	1021	52	102.0			
	48		YGSY3 - 160S20 - 05	1033	68	118.0			
	64		YGSY4 - 160S20 - 05	1045	84	134.0			
	80		YGSY5 - 160S20 - 05	1057	100	151.5			

NEW
SYM050204

PLUG (DCON20)

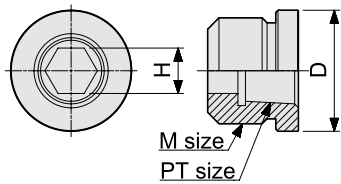

Designation	EDP No.	DCON	ØD	M size	PT size	H
PLUG M12-1/8	38000001	20	14	M12x1.0	PT 1/8	6

* Plug for turning lathe should be ordered separately.

* Clamping Torque (Nm) 0.6Nm

SYM05	Screw	Wrench
Description	TP062004-GS	TPWFTP06
EDP	18000252	18000262

Plug	DCON	Ø 20	Ø 25	Ø 32
	Description	PLUG M12-1/8	PLUG M14-1/8	PLUG M22-1/4
	EDP	38000001	38000002	38000003

X-Drill Holder (SYM06) (DC 17~20)

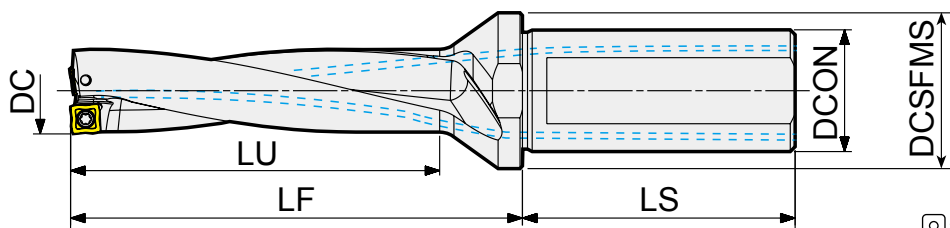

☐: p.200 Unit:mm

Series	DC	LU	Designation	EDP 3700..	LF	OAL	DCON	DCSFMS	LS
17	34		YGSY2 - 170S25 - 06	0851	54	110.0	25	32	56
	51		YGSY3 - 170S25 - 06	0855	71	127.0			
	68		YGSY4 - 170S25 - 06	0859	88	144.0			
	85		YGSY5 - 170S25 - 06	0863	105	161.0			
18	36		YGSY2 - 180S25 - 06	0852	57	113.0			
	54		YGSY3 - 180S25 - 06	0856	75	131.0			
	72		YGSY4 - 180S25 - 06	0860	93	149.0			
	90		YGSY5 - 180S25 - 06	0864	111	167.0			
19	38		YGSY2 - 190S25 - 06	0853	59	115.0			
	57		YGSY3 - 190S25 - 06	0857	78	134.0			
	76		YGSY4 - 190S25 - 06	0861	97	153.0			
20	95		YGSY5 - 190S25 - 06	0865	116	172.0			
	40		YGSY2 - 200S25 - 06	0854	63	119.0			
	60		YGSY3 - 200S25 - 06	0858	83	139.0			
	80		YGSY4 - 200S25 - 06	0862	103	159.0			
	100		YGSY5 - 200S25 - 06	0866	123	179.0			

NEW
SYM06
060204

PLUG (DCON25)

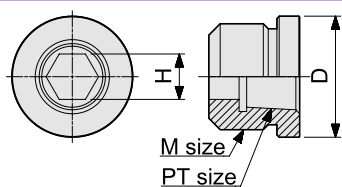

Designation	EDP No.	DCON	ØD	M size	PT size	H
PLUG M14-1/8	38000002	25	16	M14x1.0	PT 1/8	6

* Plug for turning lathe should be ordered separately.

* Clamping Torque (Nm) 0.7Nm

SYM06	Screw	Wrench
Description	TP072205-GS	TPWFTP07
EDP	18000253	18000001

Plug	DCON	Ø 20	Ø 25	Ø 32
	Description	PLUG M12-1/8	PLUG M14-1/8	PLUG M22-1/4
	EDP	38000001	38000002	38000003

Drilling - Drill Holder

X-Drill Holder (SYM07) (DC 21~23)

NEW

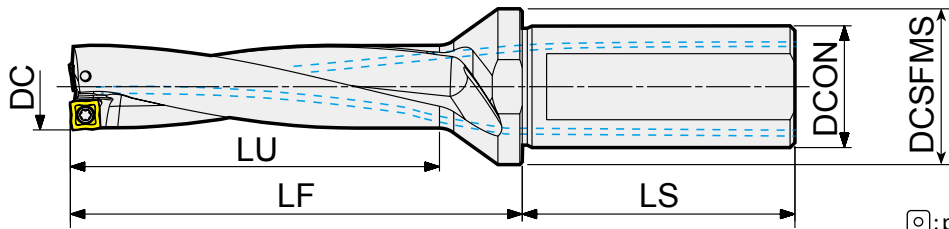

☐: p.200

Unit: mm

Series	DC	LU	Designation	EDP 3700..	LF	OAL	DCON	DCSFMS	LS
21	42		YGSY2 - 210S25 - 07	1022	65	121.0	25	32	56
	63		YGSY3 - 210S25 - 07	1034	86	142.0			
	84		YGSY4 - 210S25 - 07	1046	107	163.0			
	105		YGSY5 - 210S25 - 07	1058	128	184.0			
	44		YGSY2 - 220S25 - 07	1023	67	123.0			
22	66		YGSY3 - 220S25 - 07	1035	89	145.0			
	88		YGSY4 - 220S25 - 07	1047	111	167.0			
	110		YGSY5 - 220S25 - 07	1059	133	189.0			
23	46		YGSY2 - 230S25 - 07	1024	68	124.0			
	69		YGSY3 - 230S25 - 07	1036	91	147.0			
	92		YGSY4 - 230S25 - 07	1048	114	170.0			
	115		YGSY5 - 230S25 - 07	1060	137	193.0			

NEW
SYM07T206

PLUG (DCON25)

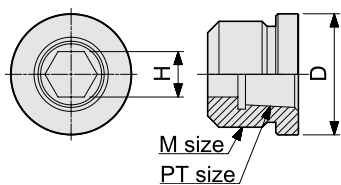

Designation	EDP No.	DCON	ØD	M size	PT size	H
PLUG M14-1/8	38000002	25	16	M14x1.0	PT 1/8	6

* Plug for turning lathe should be ordered separately.

* Clamping Torque (Nm) 0.7Nm

SYM07	Screw	Wrench
Description	TP072205-GS	TPWFTP07
EDP	18000253	18000001

Plug	DCON	Ø 20	Ø 25	Ø 32
	Description	PLUG M12-1/8	PLUG M14-1/8	PLUG M22-1/4
	EDP	38000001	38000002	38000003

Drilling - Drill Holder

X-Drill Holder (SYMX08) (DC 24~28)

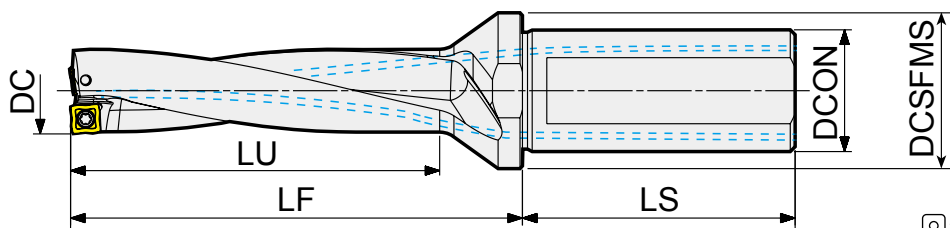

☐: p.200 Unit:mm

Series	DC	LU	Designation	EDP 3700..	LF	OAL	DCON	DCSFMS	LS
24	48		YGSY2 - 240S32 - 08	1025	70	130.0	32	45	60
	72		YGSY3 - 240S32 - 08	1037	94	154.0			
	96		YGSY4 - 240S32 - 08	1049	118	178.0			
	120		YGSY5 - 240S32 - 08	1061	142	202.0			
25	50		YGSY2 - 250S32 - 08	1026	72	132.0			
	75		YGSY3 - 250S32 - 08	1038	97	157.0			
	100		YGSY4 - 250S32 - 08	1050	122	182.0			
	125		YGSY5 - 250S32 - 08	1062	147	207.0			
26	52		YGSY2 - 260S32 - 08	1027	73	133.0			
	78		YGSY3 - 260S32 - 08	1039	99	159.0			
	104		YGSY4 - 260S32 - 08	1051	125	185.0			
	130		YGSY5 - 260S32 - 08	1063	151	211.0			
27	54		YGSY2 - 270S32 - 08	1028	77	137.0			
	81		YGSY3 - 270S32 - 08	1040	104	164.0			
	108		YGSY4 - 270S32 - 08	1052	131	191.0			
	135		YGSY5 - 270S32 - 08	1064	158	218.0			
28	56		YGSY2 - 280S32 - 08	1029	79	139.0			
	84		YGSY3 - 280S32 - 08	1041	107	167.0			
	112		YGSY4 - 280S32 - 08	1053	135	195.0			
	140		YGSY5 - 280S32 - 08	1065	163	223.0			

NEW
SYMX
080306

PLUG (DCON32)

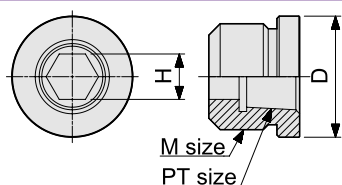

Designation	EDP No.	DCON	ØD	M size	PT size	H
PLUG M22-1/4	38000003	32	24	M22x1.25	PT 1/4	10

* Plug for turning lathe should be ordered separately.

* Clamping Torque (Nm) 1.2Nm

SYMX08	Screw	Wrench
Description	TP072506-GS	TPWFTP07
EDP	18000261	18000001

Plug	DCON	Ø 20	Ø 25	Ø 32
	Description	PLUG M12-1/8	PLUG M14-1/8	PLUG M22-1/4
	EDP	38000001	38000002	38000003

Drilling - Drill Holder

Square Drill Holder (SPMX05) (DC 13~15)

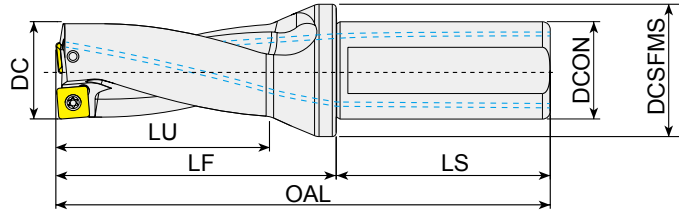

☐: p.201

Unit:mm

Series	DC	LU	Designation	EDP 3700..	LF	OAL	DCON	DCSFMS	LS
SPMX 050204	13	26	YGSP2 - 13S20F026 - 05	0001	44	94	20	25	50
		39	YGSP3 - 13S20F039 - 05	0004	57	107			
		65	YGSP5 - 13S20F065 - 05	0007	83	133			
	14	28	YGSP2 - 14S20F028 - 05	0002	46	96			
		42	YGSP3 - 14S20F042 - 05	0005	60	110			
		70	YGSP5 - 14S20F070 - 05	0008	88	138			
	15	30	YGSP2 - 15S20F030 - 05	0003	48	98			
		45	YGSP3 - 15S20F045 - 05	0006	63	113			
		75	YGSP5 - 15S20F075 - 05	0009	93	143			

* Call for us DC size increments of 0.5

* Clamping Torque (Nm) 0.6Nm

SPMX05	Screw	Wrench
Description	T062043D	TWFT06
EDP	18000177	18000031

Drilling - Drill Holder

Square Drill Holder (SPMX06) (DC 16~21)

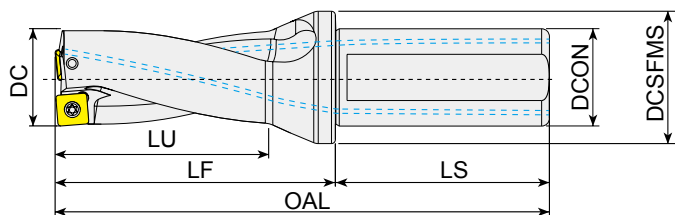

☐: p.201

Unit:mm

Series	DC	LU	Designation	EDP 3700..	LF	OAL	DCON	DCSFMS	LS
SPMX 060204	16	32	YGSP2 - 16S25F032 - 06	0010	53	109	25	32	56
		48	YGSP3 - 16S25F048 - 06	0016	69	125			
		80	YGSP5 - 16S25F080 - 06	0022	101	157			
	17	34	YGSP2 - 17S25F034 - 06	0011	55	111			
		51	YGSP3 - 17S25F051 - 06	0017	72	128			
		85	YGSP5 - 17S25F085 - 06	0023	106	162			
	18	36	YGSP2 - 18S25F036 - 06	0012	57	113			
		54	YGSP3 - 18S25F054 - 06	0018	75	131			
		90	YGSP5 - 18S25F090 - 06	0024	111	167			
	19	38	YGSP2 - 19S25F038 - 06	0013	59	115			
		57	YGSP3 - 19S25F057 - 06	0019	78	134			
		95	YGSP5 - 19S25F095 - 06	0025	116	172			
	20	40	YGSP2 - 20S25F040 - 06	0014	62	118			
		60	YGSP3 - 20S25F060 - 06	0020	82	138			
		100	YGSP5 - 20S25F100 - 06	0026	122	178			
	21	42	YGSP2 - 21S25F042 - 06	0015	64	120			
		63	YGSP3 - 21S25F063 - 06	0021	85	141			
		105	YGSP5 - 21S25F105 - 06	0027	127	183			

* Call for us DC size increments of 0.5

* Clamping Torque (Nm) 0.7Nm

SPMX06	Screw	Wrench
Description	T072252D	TWFT07
EDP	18000178	18000032

Drilling - Drill Holder

Square Drill Holder (SPMX07) (DC 22~27)

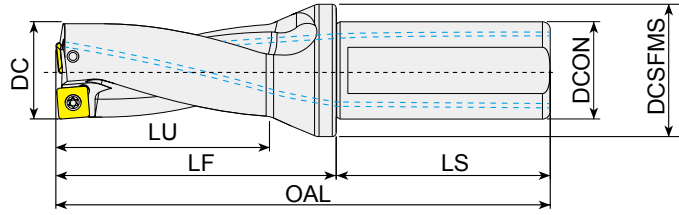

☐: p. 201

Unit: mm

Series	DC	LU	Designation	EDP 3700..	LF	OAL	DCON	DCSFMS	LS
SPMX 07T308	22	44	YGSP2 - 22S32F044 - 07	0028	74	134	32	45	60
		66	YGSP3 - 22S32F066 - 07	0034	96	156			
		110	YGSP5 - 22S32F110 - 07	0040	140	200			
	23	46	YGSP2 - 23S32F046 - 07	0029	76	136			
		69	YGSP3 - 23S32F069 - 07	0035	99	159			
		115	YGSP5 - 23S32F115 - 07	0041	145	205			
	24	48	YGSP2 - 24S32F048 - 07	0030	78	138			
		72	YGSP3 - 24S32F072 - 07	0036	102	162			
		120	YGSP5 - 24S32F120 - 07	0042	150	210			
	25	50	YGSP2 - 25S32F050 - 07	0031	80	140			
		75	YGSP3 - 25S32F075 - 07	0037	105	165			
		125	YGSP5 - 25S32F125 - 07	0043	155	215			
	26	52	YGSP2 - 26S32F052 - 07	0032	82	142			
		78	YGSP3 - 26S32F078 - 07	0038	108	168			
		130	YGSP5 - 26S32F130 - 07	0044	160	220			
27	54	YGSP2 - 27S32F054 - 07	0033	84	144				
	81	YGSP3 - 27S32F081 - 07	0039	111	171				
	135	YGSP5 - 27S32F135 - 07	0045	165	225				

* Call for us DC size increments of 0.5

* Clamping Torque (Nm) 1.2Nm

SPMX07	Screw	Wrench
Description	T082564D	TWFT08
EDP	18000179	18000033

Drilling - Drill Holder

Square Drill Holder (SPMX09) (DC 28~33)

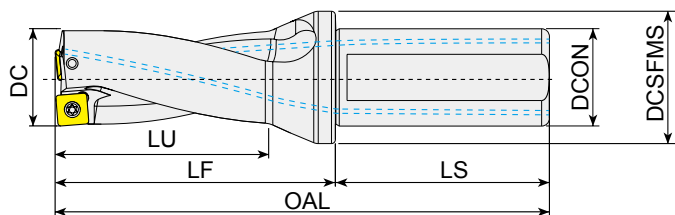

☐: p.201

Unit:mm

Series	DC	LU	Designation	EDP 3700..	LF	OAL	DCON	DCSFMS	LS
SPMX 090408	28	56	YGSP2 - 28S32F056 - 09	0046	86	146	32	45	60
		84	YGSP3 - 28S32F084 - 09	0052	114	174			
		140	YGSP5 - 28S32F140 - 09	0058	170	230			
	29	58	YGSP2 - 29S32F058 - 09	0047	88	148			
		87	YGSP3 - 29S32F087 - 09	0053	117	177			
		145	YGSP5 - 29S32F145 - 09	0059	175	235			
	30	60	YGSP2 - 30S32F060 - 09	0048	91	151			
		90	YGSP3 - 30S32F090 - 09	0054	121	181			
		150	YGSP5 - 30S32F150 - 09	0060	181	241			
	31	62	YGSP2 - 31S32F062 - 09	0049	93	153			
		93	YGSP3 - 31S32F093 - 09	0055	124	184			
		155	YGSP5 - 31S32F155 - 09	0061	186	246			
	32	64	YGSP2 - 32S32F064 - 09	0050	95	155			
		96	YGSP3 - 32S32F096 - 09	0056	127	187			
		160	YGSP5 - 32S32F160 - 09	0062	191	251			
	33	66	YGSP2 - 33S32F066 - 09	0051	97	157			
		99	YGSP3 - 33S32F099 - 09	0057	130	190			
		165	YGSP5 - 33S32F165 - 09	0063	196	256			

* Call for us DC size increments of 0.5

* Clamping Torque (Nm) 2.4Nm

SPMX09	Screw	Wrench
Description	T103588D	TWFT10
EDP	18000180	18000034

Drilling - Drill Holder

Trigonal Drill Holder (WCMX03) (DC 16~19.5)

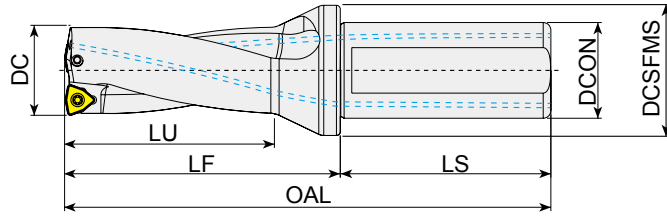

⊙: p. 202

Unit: mm

Series	DC	LU	Designation	EDP 3700..	LF	OAL	DCON	DCSFMS	LS
WCMX 030208	16	32	YGWC2 - 16S25F032 - 03	0253	54	110	25	34	56
		48	YGWC3 - 16S25F048 - 03	0296	70	126			
		64	YGWC4 - 16S25F064 - 03	0339	86	142			
	16.5	32	YGWC2 - 16.5S25F032 - 03	0780	54	110			
		48	YGWC3 - 16.5S25F048 - 03	0781	70	126			
		64	YGWC4 - 16.5S25F064 - 03	0782	86	142			
	17	34	YGWC2 - 17S25F034 - 03	0254	56	112			
		51	YGWC3 - 17S25F051 - 03	0297	73	129			
		68	YGWC4 - 17S25F068 - 03	0340	90	146			
	17.5	34	YGWC2 - 17.5S25F034 - 03	0783	56	112			
		51	YGWC3 - 17.5S25F051 - 03	0784	73	129			
		68	YGWC4 - 17.5S25F068 - 03	0785	90	146			
	18	36	YGWC2 - 18S25F036 - 03	0255	58	114			
		54	YGWC3 - 18S25F054 - 03	0298	76	132			
		72	YGWC4 - 18S25F072 - 03	0341	94	150			
	18.5	36	YGWC2 - 18.5S25F036 - 03	0786	58	114			
		54	YGWC3 - 18.5S25F054 - 03	0787	76	132			
		72	YGWC4 - 18.5S25F072 - 03	0788	94	150			
	19	38	YGWC2 - 19S25F038 - 03	0256	60	116			
		57	YGWC3 - 19S25F057 - 03	0299	79	135			
		76	YGWC4 - 19S25F076 - 03	0342	98	154			
	19.5	38	YGWC2 - 19.5S25F038 - 03	0789	60	116			
		57	YGWC3 - 19.5S25F057 - 03	0790	79	135			
		76	YGWC4 - 19.5S25F076 - 03	0791	98	154			

* Clamping Torque (Nm) 0.6Nm

WCMX03	Screw	Wrench
Description	T0622557	TWFT06
EDP	18000183	18000031

Trigonal Drill Holder (WCMX04) (DC 20~23.5)

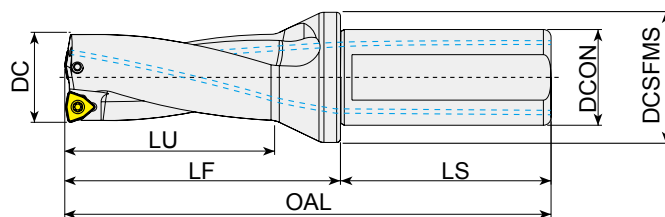

⊕ : p.202

Unit:mm

Series	DC	LU	Designation	EDP 3700..	LF	OAL	DCON	DCSFMS	LS
WCMX 040208	20	40	YGWC2 - 20S25F040 - 04	0257	62	118	25	34	56
		60	YGWC3 - 20S25F060 - 04	0300	82	138			
		80	YGWC4 - 20S25F080 - 04	0343	102	158			
	20.5	40	YGWC2 - 20.5S25F040 - 04	0726	62	118			
		60	YGWC3 - 20.5S25F060 - 04	0727	82	138			
	21	42	YGWC2 - 21S25F042 - 04	0258	64	120			
		63	YGWC3 - 21S25F063 - 04	0301	85	141			
		84	YGWC4 - 21S25F084 - 04	0344	106	162			
	21.5	42	YGWC2 - 21.5S25F042 - 04	0728	64	120			
		63	YGWC3 - 21.5S25F063 - 04	0729	85	141			
	22	44	YGWC2 - 22S25F044 - 04	0259	66	122			
		66	YGWC3 - 22S25F066 - 04	0302	88	144			
		88	YGWC4 - 22S25F088 - 04	0345	110	166			
	22.5	44	YGWC2 - 22.5S25F044 - 04	0730	66	122			
		66	YGWC3 - 22.5S25F066 - 04	0731	88	144			
	23	88	YGWC4 - 22.5S25F088 - 04	0732	110	166			
		46	YGWC2 - 23S25F046 - 04	0260	68	124			
		69	YGWC3 - 23S25F069 - 04	0303	91	147			
	23.5	92	YGWC4 - 23S25F092 - 04	0346	114	170			
		46	YGWC2 - 23.5S25F046 - 04	0733	68	124			
69		YGWC3 - 23.5S25F069 - 04	0734	91	147				

* Clamping Torque (Nm) 1.2Nm

WCMX04	Screw	Wrench
Description	T072565D	TWFT07
EDP	18000184	18000032

Drilling - Drill Holder

Trigonal Drill Holder (WCMX05) (D2416~29.5)

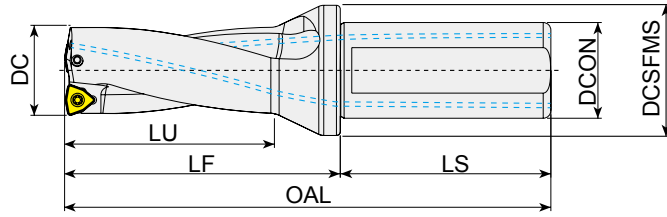

⊙: p. 202

Unit: mm

Series	DC	LU	Designation	EDP 3700..	LF	OAL	DCON	DCSFMS	LS
WCMX 050308	24	48	YGWC2 - 24S25F048 - 05	0261	70	126	25	34	56
		72	YGWC3 - 24S25F072 - 05	0304	94	150			
		96	YGWC4 - 24S25F096 - 05	0347	118	174			
	24.5	48	YGWC2 - 24.5S25F048 - 05	0735	70	126			
		72	YGWC3 - 24.5S25F072 - 05	0736	94	150			
		50	YGWC2 - 25S25F050 - 05	0262	72	128			
	25	75	YGWC3 - 25S25F075 - 05	0305	97	153			
		100	YGWC4 - 25S25F100 - 05	0251	122	178			
		25.5	50	YGWC2 - 25.5S25F050 - 05	0737	72			
	75		YGWC3 - 25.5S25F075 - 05	0738	97	153			
	26		52	YGWC2 - 26S25F052 - 05	0263	74			
		78	YGWC3 - 26S25F078 - 05	0306	100	156			
		104	YGWC4 - 26S25F104 - 05	0349	126	182			
	26.5	52	YGWC2 - 26.5S25F052 - 05	0739	74	130			
		78	YGWC3 - 26.5S25F078 - 05	0741	100	156			
		104	YGWC4 - 26.5S25F104 - 05	0742	126	182			
	27	54	YGWC2 - 27S25F054 - 05	0264	76	132			
		81	YGWC3 - 27S25F081 - 05	0307	103	159			
		108	YGWC4 - 27S25F108 - 05	0350	130	186			
	27.5	54	YGWC2 - 27.5S25F054 - 05	0743	76	132			
		81	YGWC3 - 27.5S25F081 - 05	0744	103	159			
		28	56	YGWC2 - 28S25F056 - 05	0265	78			
	84		YGWC3 - 28S25F084 - 05	0308	106	162			
	112		YGWC4 - 28S25F112 - 05	0351	134	190			
28.5	56	YGWC2 - 28.5S25F056 - 05	0745	78	134				
	84	YGWC3 - 28.5S25F084 - 05	0746	106	162				
	112	YGWC4 - 28.5S25F112 - 05	0747	134	190				
29	58	YGWC2 - 29S25F058 - 05	0266	80	136				
	87	YGWC3 - 29S25F087 - 05	0309	109	165				
	116	YGWC4 - 29S25F116 - 05	0352	138	194				
29.5	58	YGWC2 - 29.5S25F058 - 05	0748	80	136				
	87	YGWC3 - 29.5S25F087 - 05	0749	109	165				

* Clamping Torque (Nm) 1.6Nm

WCMX05	Screw	Wrench
Description	T693072D	TWFT08
EDP	18000185	18000033

Drilling - Drill Holder

Trigonal Drill Holder (WCMX06) (DC 30~44.5)

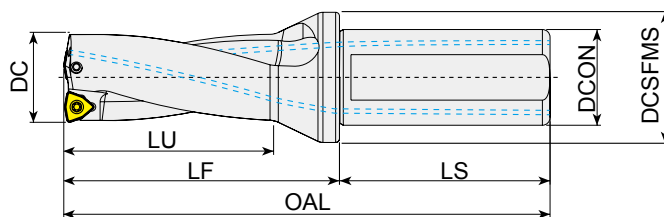

⊕ : p. 202

Unit:mm

Series	DC	LU	Designation	EDP 3700..	LF	OAL	DCON	DCSFMS	LS
WCMX 06T308	30	60	YGWC2 - 30S32F060 - 06	0267	87	147	32	44	60
		90	YGWC3 - 30S32F090 - 06	0310	117	177			
		120	YGWC4 - 30S32F120 - 06	0353	147	207			
	30.5	90	YGWC3 - 30.5S32F090 - 06	0750	117	177			
	31	62	YGWC2 - 31S32F062 - 06	0268	89	149			
		93	YGWC3 - 31S32F093 - 06	0311	120	180			
		124	YGWC4 - 31S32F124 - 06	0354	151	211			
	31.5	93	YGWC3 - 31.5S32F093 - 06	0751	120	180			
	32	64	YGWC2 - 32S32F064 - 06	0269	91	151			
		96	YGWC3 - 32S32F096 - 06	0312	123	183			
		128	YGWC4 - 32S32F128 - 06	0252	155	215			
	32.5	96	YGWC3 - 32.5S32F096 - 06	0752	123	183			
	33	66	YGWC2 - 33S32F066 - 06	0753	93	153			
		99	YGWC3 - 33S32F099 - 06	0754	126	186			
		132	YGWC4 - 33S32F132 - 06	0755	159	219			
	33.5	99	YGWC3 - 33.5S32F099 - 06	0756	126	186			
		132	YGWC4 - 33.5S32F132 - 06	0757	159	219			
	34	68	YGWC2 - 34S32F068 - 06	0271	95	155			
		102	YGWC3 - 34S32F102 - 06	0314	129	189			
		136	YGWC4 - 34S32F136 - 06	0357	163	223			
	34.5	102	YGWC3 - 34.5S32F102 - 06	0758	129	189			
	35	70	YGWC2 - 35S32F070 - 06	0272	97	157			
		105	YGWC3 - 35S32F105 - 06	0315	132	192			
		140	YGWC4 - 35S32F140 - 06	0358	167	227			
	35.5	105	YGWC3 - 35.5S32F105 - 06	0759	132	192			
	36	72	YGWC2 - 36S32F072 - 06	0273	99	159			
		108	YGWC3 - 36S32F108 - 06	0316	135	195			
		144	YGWC4 - 36S32F144 - 06	0359	171	231			
36.5	108	YGWC3 - 36.5S32F108 - 06	0760	135	195				
37	74	YGWC2 - 37S32F074 - 06	0274	101	161				
	111	YGWC3 - 37S32F111 - 06	0317	138	198				
	148	YGWC4 - 37S32F148 - 06	0360	175	235				

▶ NEXT PAGE

* Clamping Torque (Nm) 2.4Nm

WCMX06	Screw	Wrench
Description	T103588D	TWFT10
EDP	18000180	18000034

Drilling - Drill Holder

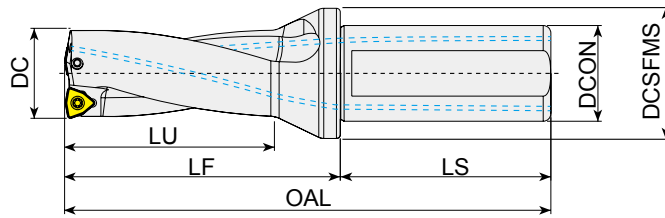
Trigonal Drill Holder (WCMX06) (DC 30~44.5)

: p. 202

Unit: mm

Series	DC	LU	Designation	EDP 3700..	LF	OAL	DCON	DCSFMS	LS
WCMX 06T308	37.5	111	YGWC3 - 37.5S32F111 - 06	0761	138	198	32	44	60
		76	YGWC2 - 38S32F076 - 06	0275	103	163			
	38	114	YGWC3 - 38S32F114 - 06	0318	141	201			
		152	YGWC4 - 38S32F152 - 06	0361	179	239			
	38.5	114	YGWC3 - 38.5S32F114 - 06	0762	141	201			
		152	YGWC4 - 38.5S32F152 - 06	0763	179	239			
	39	78	YGWC2 - 39S32F078 - 06	0276	105	165			
		117	YGWC3 - 39S32F117 - 06	0319	144	204			
	39.5	156	YGWC4 - 39S32F156 - 06	0362	183	243			
		117	YGWC3 - 39.5S32F117 - 06	0764	144	204			
	40	80	YGWC2 - 40S32F080 - 06	0277	107	167			
		120	YGWC3 - 40S32F120 - 06	0320	147	207			
	40.5	160	YGWC4 - 40S32F160 - 06	0363	187	247			
		120	YGWC3 - 40.5S32F120 - 06	0765	147	207			
	41	82	YGWC2 - 41S32F082 - 06	0278	109	169			
		123	YGWC3 - 41S32F123 - 06	0321	150	210			
	41.5	164	YGWC4 - 41S32F164 - 06	0364	191	251			
		123	YGWC3 - 41.5S32F123 - 06	0766	150	210			
	42	84	YGWC2 - 42S32F084 - 06	0279	111	171			
		126	YGWC3 - 42S32F126 - 06	0322	153	213			
	42.5	168	YGWC4 - 42S32F168 - 06	0365	195	255			
		126	YGWC3 - 42.5S32F126 - 06	0767	153	213			
	43	86	YGWC2 - 43S32F086 - 06	0280	113	173			
		129	YGWC3 - 43S32F129 - 06	0323	156	216			
	43.5	172	YGWC4 - 43S32F172 - 06	0366	199	259			
		129	YGWC3 - 43.5S32F129 - 06	0768	156	216			
	44	88	YGWC2 - 44S32F088 - 06	0281	115	175			
		132	YGWC3 - 44S32F132 - 06	0324	159	219			
44.5	176	YGWC4 - 44S32F176 - 06	0367	203	263				
	132	YGWC3 - 44.5S32F132 - 06	0769	159	219				

* Clamping Torque (Nm) 2.4Nm

WCMX06	Screw	Wrench
Description	T103588D	TWFT10
EDP	18000180	18000034

Drilling - Drill Holder

Trigonal Drill Holder (WCMX08) (DC 45~60)

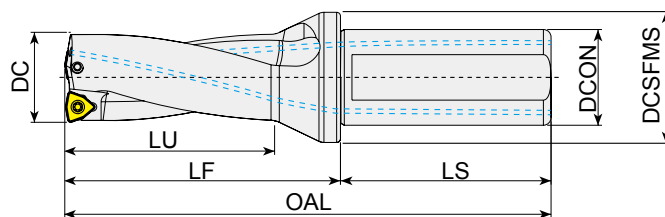

⊕: p.202

Unit:mm

Series	DC	LU	Designation	EDP 3700..	LF	OAL	DCON	DCSFMS	LS
WCMX 080412	45	90	YGWC2 - 45S40F090 - 08	0282	122	192	40	54	70
		135	YGWC3 - 45S40F135 - 08	0325	167	237			
		180	YGWC4 - 45S40F180 - 08	0368	212	282			
	45.5	135	YGWC3 - 45.5S40F135 - 08	0770	167	237			
	46	92	YGWC2 - 46S40F092 - 08	0283	124	194			
		138	YGWC3 - 46S40F138 - 08	0326	170	240			
		184	YGWC4 - 46S40F184 - 08	0369	216	286			
	47	94	YGWC2 - 47S40F094 - 08	0284	126	196			
		141	YGWC3 - 47S40F141 - 08	0327	173	243			
		188	YGWC4 - 47S40F188 - 08	0370	220	290			
	48	96	YGWC2 - 48S40F096 - 08	0285	128	198			
		144	YGWC3 - 48S40F144 - 08	0328	176	246			
		192	YGWC4 - 48S40F192 - 08	0371	224	294			
	49	98	YGWC2 - 49S40F098 - 08	0286	130	200			
		147	YGWC3 - 49S40F147 - 08	0329	179	249			
	50	196	YGWC4 - 49S40F196 - 08	0372	228	298			
		100	YGWC2 - 50S40F100 - 08	0287	132	202			
		150	YGWC3 - 50S40F150 - 08	0330	182	252			
	51	200	YGWC4 - 50S40F200 - 08	0373	232	302			
		102	YGWC2 - 51S40F102 - 08	0288	134	204			
153		YGWC3 - 51S40F153 - 08	0331	185	255				

▶ NEXT PAGE

* Clamping Torque (Nm) 3.0Nm

WCMX08	Screw	Wrench
Description	T154011D	TWFT15
EDP	18000186	18000035

Drilling - Drill Holder

Trigonal Drill Holder (WCMX08) (DC 45~60)

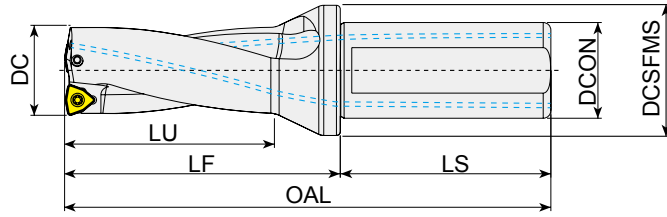

⊙: p. 202

Unit: mm

Series	DC	LU	Designation	EDP 3700..	LF	OAL	DCON	DCSFMS	LS
WCMX 080412	52	104	YGWC2 - 52S40F104 - 08	0289	136	206	40	54	70
		156	YGWC3 - 52S40F156 - 08	0332	188	258			
	53	106	YGWC2 - 53S40F106 - 08	0290	138	208			
		159	YGWC3 - 53S40F159 - 08	0333	191	261			
	54	108	YGWC2 - 54S40F108 - 08	0291	140	210			
		162	YGWC3 - 54S40F162 - 08	0334	194	264			
	55	110	YGWC2 - 55S40F110 - 08	0292	142	212			
		165	YGWC3 - 55S40F165 - 08	0335	197	267			
	56	112	YGWC2 - 56S40F112 - 08	0293	144	214			
		168	YGWC3 - 56S40F168 - 08	0336	200	270			
	57	114	YGWC2 - 57S40F114 - 08	0294	146	216			
		171	YGWC3 - 57S40F171 - 08	0337	203	273			
	58	116	YGWC2 - 58S40F116 - 08	0295	148	218			
		174	YGWC3 - 58S40F174 - 08	0338	206	276			
	59	118	YGWC2 - 59S40F118 - 08	0771	150	220			
		177	YGWC3 - 59S40F177 - 08	0772	209	279			
	60	120	YGWC2 - 60S40F120 - 08	0773	152	222			
		180	YGWC3 - 60S40F180 - 08	0774	212	282			

WCMX08	Screw	Wrench
Description	T154011D	TWFT15
EDP	18000186	18000035

* Clamping Torque (Nm) 3.0Nm

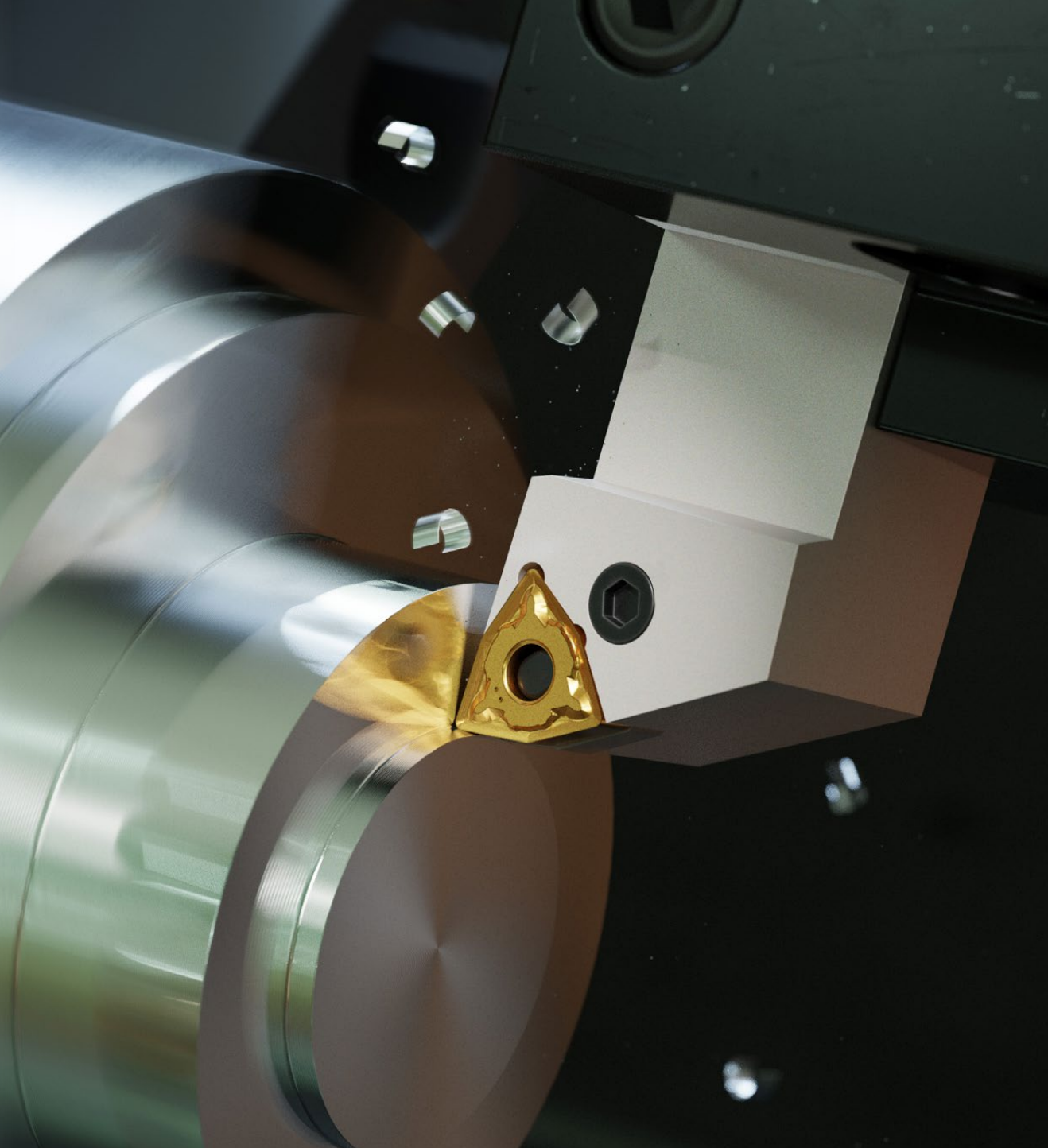

TECHNICAL INFORMATION

ISO 13399 Terms

Hardness Conversion Table

Formulas

Recommended Cutting Conditions

Material Groups

Comparison Chart

ISO ↔ ANSI

Search

Technical Information

ISO 13399 Terms

AN	Clearance angle major	INSD	Insert diameter
APMX	Maximum depth of cut	KAPR	Tool cutting edge angle
AS	Clearance angle wiper edge	KRINS	Cutting edge angle major
B	Shank width	KWW	Keyway width
BS	Wiper edge length	L	Cutting edge length
CBDP	Connection bore depth	LE	Cutting edge effective length
CDX	Cutting depth maximum	LF	Functional length
CICT	Number of Inserts	LH	Head length
CW	Cutting width	LS	Shank length
CZC	Connection size code	LU	Usable length
DC	Cutting diameter	LUX	Usable length maximum
DCON	Connection diameter	M	Nose (or Wiper) Height
DCSFMS	Contact surface diameter machine side	OAL	Overall length
DCX	Cutting diameter maximum	RE	Corner radius
DMIN	Minimum bore diameter	RMPX	Maximum ramping angle
DMM	Shank diameter	RPMX	Rotational speed maximum
EPSR	Insert included angle	S	Insert thickness
H	Shank height	TDZ	Thread diameter size
HAND	Hand	WF	Functional width
IC	Inscribed circle diameter		

Technical Information

Hardness Conversion Table

	HB	HRc	HRB	HV	N/mm ²	
TURNING	199	15	93	199	667	
	203	16	94	201	680	
	208	17	95	210	696	
	212	18	95	218	706	
	216	19	96	222	716	
	223	20	97	227	755	
PARTING & GROOVING	229	21	98	235	775	
	233	22	99	241	794	
	240	23	100	247	824	
	245	24	100	252	838	
	250	25	101	255	853	
	255	26	102	258	870	
	262	27	103	262	880	
	264	28	103	271	892	
	271	29	104	277	941	
	277	30	105	285	971	
MILLING	290	31	106	292	990	
	300	32	107	303	1020	
	308	33	107	311	1035	
	314	34	108	320	1049	
	322	35	108	332	1089	
	331	36	109	342	1118	
	341	37	109	351	1157	
	348	38	110	361	1187	
	360	39	111	376	1236	
	373	40	111	388	1265	
DRILLING	375	41	112	393	1314	
	388	42	113	406	1363	
	402	43	114	424	1390	
	415	44	114	438	1422	
	419	45	114	448	1447	
	430	46	115	458	1471	
	445	47	115	474	1520	
	456	48	116	490	1569	
	468	49	117	497		
	469	50	117	505		
	486	51	118	531		
	504	52	118	549		
	513	53	119	567		
	534	54	120	589		
TECHNICAL INFORMATION	552	55		649		
	572	56		694		
	592	57		727		
	601	58		746		
	613	59				
	627	60				
	642	61				
	658	62				
	681	63				
	695	64				
		HB	HRc	HRB	HV	N/mm ²

Technical Information

Formulas

Formulas

Cutting Speed (Vc)	Metric $Vc = D \times RPM \times 0.0031$ (m/min.)	Inch $Vc = D \times RPM \times .262$ (ft/min.)
	Metric Vc to Inch Vc $Inch\ Vc = Metric\ Vc \times 3.28$ (ft/min.)	
	Inch Vc to Metric Vc $Metric\ Vc = Inch\ Vc \times .305$ (m/min.)	

Turning Formulas

Spindle Speed (RPM)	Metric $RPM = Vc \times 318.3 \div D$ (rev./min.)	Inch $RPM = Vc \times 3.82 \div D$ (rev./min.)
Feed Rate (Vf = Table Feed)	$Vf = Fn \times RPM$ (mm/min. or in/min.)	
Feed per Revolution (Fn)	$Fn = Vf \div RPM$ (mm/rev. or in/rev.)	
Metal Removal Rate (Q)	Metric $Q = Vc \times Fn \times Ap$ (cm ³ /min.)	Inch $Q = Vc \times Fn \times Ap \times 12$ (in ³ /min.)
Cutting Time	$T = L \div Vf$ (min.)	

Milling Formulas

Feed per Revolution (Fn)	$Fn = Vf \div RPM$ (mm/rev. or in/rev.) $= Fz \times \text{Number of tooth}$ (mm/rev. or in/rev.)	
Feed per Tooth (Fz)	$Fz = Vf \div RPM \div \text{Number of tooth}$ (mm/rev. or in/rev.) $= Fn \div \text{Number of tooth}$ (mm/rev. or in/rev.)	
Metal Removal Rate (Q)	Metric $Q = Ap \times Ae \times Vf \div 1000$ (cm ³ /min.)	Inch $Q = Ap \times Ae \times Vf$ (in ³ /min.)
Cutting Time	$T = L \div Vf$ (min.)	
Power Consumption (Pc)	Metric $Pc = Ap \times Ae \times Vf \times Kc \times 0.000000017$ (kW)	Inch $Pc = Ap \times Ae \times Vf \times Kc \times 0.00000253$ (Hp)

Drilling Formulas

Power Consumption (Pc)	Metric $Pc = Fn \times Vc \times D \times Kc \times 0.0000042$ (kW)	Inch $Pc = Fn \times Vc \times D \times Kc \times 0.0000076$ (Hp)
Torque (Mc)	Metric $Mc = Pc \times 9554.1 \div RPM$ (Nm)	Inch $Mc = Pc \times 5255 \div RPM$ (lbf ft)
Thrust (T)	$T \approx 0.5 \times Kc \times DC/2 \times Fn \times \sin KAPR$ (N)	

Terms

RPM (n)	Spindle Speed (Revolution per minute)
Vc	Cutting Speed
D	Work Diameter
Vf	Feed Rate (Table Feed)
Fn	Feed per Revolution
Ap	Depth of Cut
Q	Metal Removal Rate
L	Length of cut
T	Cutting Time (min.)

Technical Information

Recommended cutting conditions

Turning

Cutting Speed			Vc (m/min.)															
ISO	VDI	Sub Group	YG1010		YG1001		YG3010		YG3015		YG3115		YG3020		YG3030		YG801	
			Min	Max	Min	Max	Min	Max	Min	Max	Min	Max	Min	Max	Min	Max	Min	Max
P	1~5	Non-Alloyed Steel	-	-	220	480	230	450	200	430	180	500	160	380	130	350	120	200
	6~9	Low-Alloyed Steel	-	-	220	420	180	380	150	350	170	450	140	320	130	280	70	200
	10~11	High-Alloyed Steel	-	-	-	-	60	200	90	180	60	300	60	130	70	110	-	-
M	12~13	Ferritic & Martensitic	-	-	-	-	-	-	-	-	-	-	-	-	-	-	-	-
	14	Austenitic Stainless Steel	-	-	-	-	-	-	-	-	-	-	-	-	-	-	-	-
K	15~16	Grey Cast Iron	300	450	250	420	120	300	-	-	-	-	-	-	-	-	-	-
	17~18	Nodular Cast Iron	120	350	120	300	120	280	-	-	-	-	-	-	-	-	-	-
N	21~30	Non-Ferrous Metals (Al)	-	-	-	-	-	-	-	-	-	-	-	-	-	-	-	-
S	31~37	Superalloys & Titanium	-	-	-	-	-	-	-	-	-	-	-	-	-	-	-	-
H	38~41	Hard Materials	-	-	-	-	-	-	-	-	-	-	-	-	-	-	-	-

Turning

Cutting Speed			Vc (m/min.)															
ISO	VDI	Sub Group	YG2025		YG211		YG213		YG214		YG401		YT100		YG100		YG10	
			Min	Max	Min	Max	Min	Max	Min	Max	Min	Max	Min	Max	Min	Max	Min	Max
P	1~5	Non-Alloyed Steel	-	-	-	-	-	-	-	-	-	-	-	-	-	-	-	-
	6~9	Low-Alloyed Steel	-	-	-	-	-	-	-	-	-	-	-	-	-	-	-	-
	10~11	High-Alloyed Steel	-	-	-	-	-	-	-	-	-	-	-	-	-	-	-	-
M	12~13	Ferritic & Martensitic	170	220	170	270	120	180	100	150	-	-	-	-	-	-	-	-
	14	Austenitic Stainless Steel	150	200	150	230	40	160	100	150	-	-	-	-	-	-	-	-
K	15~16	Grey Cast Iron	-	-	-	-	-	-	-	-	-	-	-	-	-	-	-	-
	17~18	Nodular Cast Iron	-	-	-	-	-	-	-	-	-	-	-	-	-	-	-	-
N	21~30	Non-Ferrous Metals (Al)	-	-	-	-	-	-	-	-	-	-	-	250	1200	250	800	
S	31~37	Superalloys & Titanium	-	-	30	100	30	70	30	50	30	90	-	-	-	-	-	
H	38~41	Hard Materials	-	-	-	-	-	-	-	-	-	-	-	-	-	-	-	

Parting & Grooving

Cutting Speed			Vc (m/min.)			
ISO	VDI	Sub Group	YG602G (YG602)		YG603	
			Min	Max	Min	Max
P	1~5	Non-Alloyed Steel	120	180	-	-
	6~9	Low-Alloyed Steel	100	140	-	-
	10~11	High-Alloyed Steel	80	110	-	-
M	12~13	Ferritic & Martensitic	70	160	50	90
	14	Austenitic Stainless Steel	55	140	40	80
K	15~16	Grey Cast Iron	110	185	-	-
	17~18	Nodular Cast Iron	110	140	-	-
N	21~30	Non-Ferrous Metals (Al)	250	440	-	-
S	31~37	Superalloys & Titanium	25	45	-	-
H	38~41	Hard Materials	25	50	-	-

Technical Information

Recommended cutting conditions

Nanocut

YG812 GRADE			Cutting Speed		Feed per Revolution (Fn)	
ISO	VDI	Sub Group	Vc (m/min.)		Fn (mm/rev.)	
			Min	Max	Min	Max
P	1~5	Non-Alloyed Steel	170	200	0.015	0.025
	6~9	Low-Alloyed Steel	95	160	0.015	0.025
	10~11	High-Alloyed Steel	85	95	0.015	0.025
M	12~13	Ferritic & Martensitic	105	140	0.015	0.025
	14	Austenitic Stainless Steel	95	130	0.015	0.025
K	15~16	Grey Cast Iron	140	190	0.015	0.025
	17~18	Nodular Cast Iron	140	190	0.015	0.025
N	21~30	Non-Ferrous Metals (Al)	-	-	-	-
S	31~37	Superalloys & Titanium	10	75	0.015	0.025
H	38~41	Hard Materials	-	-	-	-

Milling

Cutting Speed																						
ISO	VDI	Sub Group	YG012		YG712		YG713		YG622		YG612		YG602		YG613		YG501(G)		YG5020		YG50	
			Min	Max	Min	Max	Min	Max	Min	Max	Min	Max	Min	Max	Min	Max	Min	Max	Min	Max	Min	Max
P	1~5	Non-Alloyed Steel	180	280	170	300	200	300	140	400	180	280	180	270	100	210	-	-	-	-	-	-
	6~9	Low-Alloyed Steel	150	250	180	250	170	270	120	320	150	250	150	240	70	180	-	-	-	-	-	-
	10~11	High-Alloyed Steel	80	150	100	140	85	145	70	170	70	140	70	130	40	90	-	-	-	-	-	-
M	12~13	Ferritic & Martensitic			-	-	-	-	-	-	120	200	120	180	70	180	-	-	-	-	-	-
	14	Austenitic Stainless Steel			-	-	-	-	-	-	130	250	30	230	70	200	-	-	-	-	-	-
K	15~16	Grey Cast Iron			-	-	-	-	120	270			120	250	-	-	160	300	200	350	-	-
	17~18	Nodular Cast Iron			-	-	-	-	130	240			120	220	-	-	130	210	150	300	-	-
N	21~30	Non-Ferrous Metals (Al)			-	-	-	-	-	-			-	-	-	-	-	-	-	-	300	800
S	31~37	Superalloys & Titanium			-	-	-	-	-	-	25	45	5	45	-	-	-	-	-	-	-	-
H	38~41	Hard Materials	70	120	-	-	-	-	40	100					-	-			-	-	-	-

Drilling

Cutting Speed			Vc (m/min.)					
ISO	VDI	Sub Group	YG602		YG713		YG613	
			Min	Max	Min	Max	Min	Max
P	1~5	Non-Alloyed Steel	180	380	200	300	100	210
	6~9	Low-Alloyed Steel	120	300	170	270	70	180
	10~11	High-Alloyed Steel	70	150	85	145	40	90
M	12~13	Ferritic & Martensitic	120	200	-	-	70	180
	14	Austenitic Stainless Steel	130	250	-	-	70	200
K	15~16	Grey Cast Iron	120	250	-	-	-	-
	17~18	Nodular Cast Iron	130	220	-	-	-	-
H	38~41	Hard Materials	-	-	-	-	-	-

Technical Information

Material Groups

TURNING
PARTING & GROOVING
MILLING
DRILLING
TECHNICAL INFORMATION

ISO	VDI 3323	Material Description	Composition / Structure / Heat Treatment		HB	HRc	Examples	
P	1	Non-alloyed steel	About 0.15% C	Annealed	125		S15C, C15, 1015	
	2		About 0.45% C	Annealed	190	13	S45C, C45, 1045	
	3		About 0.45% C	Quenched & Tempered	250	25		
	4		About 0.75% C	Annealed	270	28	SK5, Ck75, 1080	
	5		About 0.75% C	Quenched & Tempered	300	32		
	6	Low-alloyed Steel		Annealed	180	10	SCM440, 42CrMo4, 410	
	7			Quenched & Tempered	275	29		
	8			Quenched & Tempered	300	32		
	9			Quenched & Tempered	350	38		
	10	High-alloyed steel, and tool steel		Annealed	200	15	SKD, D2	
	11			Quenched & Tempered	325	35	SKH, SUH, M42	
M	12	Stainless Steel	Ferritic / Martensitic	Annealed	200	15	SUS 420, X40Cr13, 420	
	13		Martensitic	Quenched & Tempered	240	23		
	14		Austenitic		180	10	SUS 316, 316, X5CrNiMo 17 12 2	
K	15	Grey cast iron	Pearlitic / Ferritic		180	10	FC, GG, EN-GJL-250	
	16		Pearlitic (Martensitic)		260	26		
	17	Nodular cast iron	Ferritic		160	3	FCD, GGG, EN-GJS-500-7	
	18		Pearlitic		250	25		
	19	Malleable cast iron	Ferritic		130		FCMW, FCMP, GTS, GJMB350-10	
20	Pearlitic			230	21			
N	21	Aluminum-wrought alloy	Not Curable		60		SAE 1000, AlMg 1, 3.3315	
	22		Curable Hardened		100		SAE 7050, AlCuMg 1, 3.1325	
	23	Aluminum-cast, alloyed	≤ 12% Si, Not Curable		75		ADC12, G-AlSi12, 3.2581	
	24		≤ 12% Si, Curable Hardened		90		C4BS, G-AlSi10Mg, 3.2381	
	25		> 12% Si, Not Curable		130			
	26		Cutting Alloys, PB>1%		110		CuZn36Pb 3, 2.0375	
	27	Copper and copper alloys (Bronze / Brass)	CuZn, CuSnZn (Brass)		90		CuZn 15, 2.0240	
	28		CuSn, lead-free copper and electrolytic copper		100		G-CuZn40Fe, 2.0590	
	29	Non-metallic materials	Duroplastic, Fiber Reinforced Plastic					CFRP
	30		Rubber, Wood, etc.					
S	31	Heat resistant super alloys	Fe Based	Annealed	200	15	X12 NiCrSi 36-16, 1.4864	
	32			Aged	280	30		
	33			Annealed	250	25	Inconel 718, NiCr20TiAl, 2.4631	
	34		Ni or Co Based	Aged	350	38	NiCu30Al, 2.4375	
	35			Cast	320	34	G-X120Mn12, 1.3401	
	36	Titanium alloys	Pure Titanium		400 Rm			
	37		Alpha + Beta Alloys	Hardened	1050Rm		TiAl6V4, 3.7165	
H	38	Hardened steel	Hardened		550	55	SK3	
	39		Hardened		630	60		
	40	Chilled cast iron	Cast		400	42		
	41	Hardened cast iron	Hardened		550	55		

Technical Information

Material Groups

Mat'l No.	JIS	DIN	Material Description			Composition / Structure / Heat Treatment					HB 125	HRC
			AISI/ASTM/SAE	BS	EN	About 0.15% C, Annealed						
						AFNOR	SS	UNI	UNE / IHA	UNS	GOST	Brands
1.0037	STKM 12 C	St 37-2	-	4360 40 B	S235JR	E24-2	1311	Fe 360 B			16D	
1.0038	STKM 12 A	St 37-3	A570.36	4360 40 C	S275J2G3	E28-3	1312	Fe 360 D FF			ST14KP	
1.0045	SM 490 YA	S 355 JR	-	-	S 1207	E36-2	-	Fe 510 BFN				
1.0050	SS 50	St 50-2	A570 Gr.50	4360 50 B	E 295	A50-2	2172	Fe 490			ST5PS	
1.0060	SM 58	St 60-2	A572 Gr.65	4360 55 E	-	A60-2	1650	Fe 60-2			ST6PS	
1.0114		S 235 J0	-	En 40C	S 235 J0	E24-3		Fe 360 CFN				
1.0143		S 275 J0	-	-	S 275 J0	E28-3	1414	Fe 430 C				
1.0144	SM41C, SM400	St 44-3 N	A573 Gr.81	4360 43C	S 275 J2 G3	E28-3	1412	Fe 430 D FF			ST14KP	
1.0149		Ro St 44-2	-	43C	S 275 J0 H	-	1412	Fe430C				
1.0301	S10C	C10	1010	045M10	C10	34C10, XC10		C10	F.1511	G10100	10	
1.0330	SPCC	St 12	-	DC 01	Fe P01	DC 01/Fe P01	1142	Fe P01			15KP	
1.0335	SPHE	DD 13 (StW 24)	A622(1008)	H S 3	DD 13	3C		FeP13			08KP	
1.0338	SPCE	St 4	A620(1008)	14491CR	Fe P04	Fe 14	1147	DC04/FeP04			08JU	
1.0345	SPV 50	P235 GH	A516 Gr.65	P 235 GH	P 235 GH	A 37 CP	1330	Fe E 235		K02503		
1.0401	S15C	C15	1015	080M15	-	C18RR, XC18	1350	C15, C16	F.1110	G10170	15	
1.0402	S20C	C22	1020	050 A 20	1 C 22	C20	1450	C 20	F.1120	G10200	20	
1.0425	SPV315	P265GH/Hll				A42CP	1430	Fe4101KW		K02801	16K	
1.0443	SC 450	GS-45	A2765-35	A1		E23-45M	1305					
1.0539		S355NH				TSE355-4	2134	Fe510B				
1.0545		S355N		4360-50E		E355R	2334	FeE355KG				
1.0546		S355NL		4360-50EE		E355FP	2135	FeE355KT				
1.0547		S355J0H		4360-50C		TSE355-3	2172	Fe510C				
1.0549		S355NLH					2135	Fe510D				
1.0553	SM 520 M	St52-3U	A14880-40	4360-50C		320-560M	1606	Fe510C				
1.0562	SM490A	St E 355	A633 Gr.C	P 355 N		FeE355KGN	2132	Fe E 355 KG		K12000	15GF	
1.0565		W St E 355		P 355 NH		P 355 NH	2106	Fe E 355 KW		K01600		
1.0566	SLA 37	T St E 355		P 355 NL1		P 355 NL1	2107	Fe E 355 KT				
1.0570	SM 50 YA	St 52-3	1	4360-50 C	S355JR	E36-3	2172	Fe 510 B			17G15	
1.0715	SUM22	95Mn28	1213	230M07		S250	1912	CF5Mn28	F.2111	G12130		
1.0718	SUM22L	95MnPb28	12L13			S250Pb	1914	CF95MnPb28	F.2112	G12134		
1.0721		10S20	1108	10S20		10S20		CF10S20	F.2121	G11080		
1.0722		10SPb20	11L08			10PbF2		CF10SPb20		G11084		
1.0736	SUM25	95Mn36	1215			S300		CF9Mn36	F.2113	G12150		
1.0737		95MnPb36	12L14			S300Pb	1926	CF95MnPb36	F.2114	G12144		
1.0972		S315MC		1501-40F30		E315D						
1.0976		S355MC		1501-43F35		E355D	2642	FeE355TM				
1.0982		S460MC		1501-50F45								
1.0984		S500MC				E490D	2662	FeE490TM				
1.0986		S500MC		1501-60F55		E560D		FeE560TM				
1.1121	S10C	Ck10	1010	040A10		XC10	1265	C10	F.1510	G10100	10	
1.1141	S15	Ck15	1015	040A15	32C	XC15	1370	C15	F.1110	G10150	15	
1.1151	S20C	C22E	1020	055M15		2C22	1450	C20	F.1120	G10230	20	
1.8900	S25C	StE380	A572-60	436055E			2145	FeE390KG				
		St44-2	A36	436043A		NFA35-501E28	1411					
		StE320-3Z		1501160			1421					

Technical Information

Material Groups

TURNING

PARTING & GROOVING

MILLING

DRILLING

TECHNICAL INFORMATION

Mat'l No.	JIS	DIN	Material Description			Composition / Structure / Heat Treatment					HB	HRc
			AISI/ASTM/SAE	BS	EN	About 0.45% C, Annealed						
1.0501	S35C	C35	1035	080A32		1C35	1572	C35	F.113	G10350	35	13
1.0503	S45C	C45	1045	060A47		XC42HITS	1672	C45	F.114	G10450	45	
1.0511	S40C	C40	1040	080M40		1C40		C40	F.114.A	G10400	40	
1.0540	S 50 C	C50					1674	C50		G10500		
1.0551		G5-52	A2770-36	A2		280-480M	1505					
1.0553	SM 520 M	S152-3U	A14880-40	4360-50C		320-560M	1606	Fe510C				
1.0577		S 355 J 2 G 4	A738	Fe 510 D 2 FF		A52FP	2107					
1.0726		35S20	1140	212M36	8M	35MF6	1957			G11400	40	
1.0727		45S20	1146			45MF4	1973			G11460		
1.1157		40Mn4	1039	150M36	15	40M5				G10390	40G	
1.1158	S25C	C25E	1025	070M25		XC25		C25	F.1120	G10250	25	
1.1166	SMn433H	34Mn5	1536						TO.B	G15360		
1.1167	SMn438(H)	36Mn5	1335	150M36		40M5	2120	36Mn6	F.1203	G13350	35G2	
1.1170	SCMn1	28Mn6	1330	150M28	14A	20M5		C28Mn	28Mn6	G13300	30G	
1.1178	S 30 C	C30E		080M30		XC32		C30	2C30	G10300		
1.1180		C35R	1035	080A35		3C35	1572		F.1135	G10350		
1.1181	S35C	C35E	1035	080A35		XC38	1572	C36	F.1130	G10340	35	
1.1191	S45C	Ck45	1045	080A46		XC45	1672	C45	F.1140		45	
1.1206	S 50 C	C50E	1050	080M50		2C50	1674	C50		G10500	50	
1.1213	S50C	Cf53	1050	070M55		XC48HTS	1674	C53		G10500	50	

Mat'l No.	JIS	DIN	Material Description			Composition / Structure / Heat Treatment					HB	HRc
			AISI/ASTM/SAE	BS	EN	About 0.45% C, Annealed						
1.0481	SG365	17 Mn 4/P 295 GH	A516 Gr.70	224-460B	P 295 GH	A 48 CP	2102	Fe E 295	A47RCI	K03501	14G2	
1.0501	S35C	C35	1035	080A32		1C35	1572	C35	F.1130	G10350	35	
1.0503	S45C	C45	1045	060A47		XC42HITS	1672	C45	F.1140	G10450	45	
1.0614		C76D	1074			XC75				G10750		
1.0616		C86D	1086			XC80		C85		G10860		
1.0618		C92D	1095			XC90				G10950		
1.0726		35S20	1140	212M36	8M	35MF6	1957			G11400	40	
1.1157		40Mn4	1039	150M36	15	40M5				G10390	40G	
1.1165	SMn433H	30Mn5	1036	120M36		35M5		30Mn5	F.8211	K13300	30G2	
1.1167	SMn438(H)	36Mn5	1335	150M36		40M5	2120	36Mn6	F.1203	G13350	35G2	
1.1186	S40C	C40E	1040	060A40		2C40		C40		G10400		
1.1191	S45C	Ck45	1045	080M46		2C45	1672	C45	F.1140		45	
1.1201	S50C	C45R	1049	080M46		3C45	1660	C45	F.1145		38HM	
1.1213	S50C	Cf53	1050	070M55		XC48HTS	1674	C53		G10500	50	
1.7242	SCM418 H	18CrMo4										
1.7337		16CrMo4-4	A387 Gr.12					A18CrMo45KW		K11564	15CM	
1.7362	SCMV 6	12CrMo195		3606-625		Z10CD5-05		16CrMo205		K41545		
		17MnV6	A572-60	436055E		NFA35-501E36	2142					

Technical Information

Material Groups

Mat'l No.	JIS	DIN	Material Description			Composition / Structure / Heat Treatment					HB	HRC
			AISI/ASTM/SAE	BS	EN	AFNOR	SS	UNI	UNE / IHA	UNS	GOST	Brands
<div style="display: flex; justify-content: space-between; align-items: center;"> <div style="font-size: 2em; font-weight: bold; color: #0070C0;">P</div> <div style="text-align: center;"> VDI 3323 4 </div> <div style="text-align: center;"> Material Description Non-alloyed steel </div> <div style="text-align: center;"> Composition / Structure / Heat Treatment About 0.75% C, Annealed </div> <div style="text-align: center;"> HB 270 </div> <div style="text-align: center;"> HRC 28 </div> </div>												
1.0603	S70 C-CSP	C67	107	080A67		XC65		C67		G10700		
1.0605		C75	1075	144980HS				C75		G10740	75	
1.1203	S55C	Ck55	1055	060A57		2C55	1655	C55	F.1150	G10550	55	
1.1209		C55R	1055	070M55		3C55		C55	F.1155	G10550		
1.1221	S58C	Ck60	1060	060A62	43D	2C60	1678	C60	F.1150	G10640	60	
1.1231	S70 C-CSP	C67E	1070	060A67		XC68	1770	C70	F5103	G10700	65GA	
1.1248	C75	C75E	1074	060A78		XC75	1774	C75	F5107	G10800	75(A)	
1.1269	SK5-CSP	C85E	1086			XC90		C90		G10900	85(A)	
1.1274	SUP4	Ck101	1095	060 A96	C 100S	XC100	1870	C100	F5117	G10950		
1.1545	SK3	C105W1	W1	BW 2	C 105U	Y1 105	1880	C 100 KU	F5118		U10A	
1.1663	SK2	C125W	W112			Y2120					U13	

Mat'l No.	JIS	DIN	Material Description			Composition / Structure / Heat Treatment					HB	HRC
			AISI/ASTM/SAE	BS	EN	AFNOR	SS	UNI	UNE / IHA	UNS	GOST	Brands
<div style="display: flex; justify-content: space-between; align-items: center;"> <div style="font-size: 2em; font-weight: bold; color: #0070C0;">P</div> <div style="text-align: center;"> VDI 3323 5 </div> <div style="text-align: center;"> Material Description Non-alloyed steel </div> <div style="text-align: center;"> Composition / Structure / Heat Treatment About 0.75% C, Quenched & Tempered </div> <div style="text-align: center;"> HB 300 </div> <div style="text-align: center;"> HRC 32 </div> </div>												
1.0070		St 70-2	1055	Fe690-2FN	-	A70-2	1655	Fe 690	F.1150		55	
1.0535	S55C	C55	1055	070M55		1C55	1655	C55		J05000	55	
1.0601	S58C	C60	1060	060A62	43D	1C60		C60		G10600	60(G)	
1.1203	S55C	Ck55	1055	060A57		2C55	1655	C55	F.1150	G10550	55	
1.1221	S58C	Ck60	1060	060A62	43D	2C60	1678	C60	F.1150	G10640	60	
1.1274	SUP4	Ck101	1095	060 A96	C 100S	XC100	1870	C100	F5117	G10950		
1.1545	SK3	C105W1	W1	BW 2	C 105U	Y1 105	1880	C 100 KU	F5118		U10A	
1.1663	SK2	C125W	W112			Y2120					U13	
1.5120		38MnSi4										
1.5710	SNC236	36NiCr6	3135	640A35	111A	35NC6						
1.7701		51CrMoV4						51CrMoV4				

Technical Information

Material Groups

Mat'l No.	JIS	DIN	Material Description			Composition / Structure / Heat Treatment					HB	HRC
			AISI/ASTM/SAE	BS	EN	Annealed					180	10
<div style="display: flex; justify-content: space-between; align-items: center;"> <div style="font-size: 2em; font-weight: bold; color: blue;">P</div> <div style="text-align: center;"> VDI 3323 6 </div> <div style="text-align: center;"> Material Description Low-alloyed Steel </div> <div style="text-align: center;"> Composition / Structure / Heat Treatment Annealed </div> <div style="text-align: center;"> HB 180 </div> <div style="text-align: center;"> HRC 10 </div> </div>												
Mat'l No.	JIS	DIN	AISI/ASTM/SAE	BS	EN	AFNOR	SS	UNI	UNE / IHA	UNS	GOST	Brands
1.0116		St 37-3	A570 Gr. 36	4360-40C	S 235 J2 G3	E24-3	1312	Fe 360 D1(2)	AE235D		ST3KP	
1.0904	SKH 1, SKT 4	55Si7	9255	250A53	45	55S7	2085	55Si8	56Si7	G92550	55S2	
1.0961	SUP 7	60SiCr7	9262			60SC6		60SiCr8	60SiCr8	G92620		
1.2067		100Cr6	L3	BL3		Y100C6			100Cr6			
1.2108		90CrSi5	L1				2092	105WCR5				
1.2210		115CrV3	L2			100C3		107CrV3KU	F520L		11KHF	
1.2241		51CrV4										
1.2330	SCM435TK	35CrMo4	4135	708A37		34CD4	2234	35CrMo4			35KHM	
1.2419	SKS31	105WCr6		105WC13		105WC13	2140	10WCr6			CWG	
1.2510	SKS3	100MnCrW4	O1	BO1		90 MWCV 5	2140	95 MnWCr 5 KU	F5220		9KHVG	
1.2542		45WCrV7	S1	BS1			2710	45WCrV8KU			5CW25F	
1.2550		60WCrV7	S1			55WC20	2710	58WCr9KU			5KHV25F	
1.2713	SKT4	55NiCrMoV6	L6			55NCDV7			F520S		5C NM	
1.2721		50NiCr13	L6			55NCV6	2550		F528			
1.2842		90MnCrV8	O2	BO2		90MV8				T31502	9G2F	
1.3501		100Cr2	E50100									
1.3505	SUJ2	100Cr6	52100	2S135	31	100C6	2258	100Cr6	F.1310		SCC 15	
1.5024		46Si7				45S7		46Si7	F.1451			
1.5025		51Si7	9259H		50Si7	51S7	2090	50Si7	F.1450			
1.5026		55Si7			56Si7	55S7	2085	55Si7	F.1440	G92550	55S2	
1.5027		60Si7	9260	251A60	60Si7	60S7		60Si7	F.1441	G92600	60S2	
1.5028	SUP7	65Si7	9260H									
1.5415	STFA 12	15Mo3	A204Gr.A	1503-243B		15D3	2912	16Mo3(KG)	F.2601	K11820		
1.5419	SCPH11	20Mo4	4419	1503-243-430			2512	G20Mo5		G44190		
1.5423	SB450M	16Mo5	4520	1503-245-420				16Mo5(KG)	F.2602	K11522		
1.5622		14Ni6	A350-LF5			16N6		14Ni6(KG)	F.2641			
1.5732	SNC415(H)	14NiCr10	3415			14NC11		16NiCr11				
1.5752	SNC815(H)	14NiCr14	3310	655M13	36A	12NC15					20X2H4A	
1.6511	SUP10	36CrNiMo4	9840	816M40	110	40NCD3		36NiCrMo4(KB)			40CN2MA	
1.6523	SNCM220(H)	21NiCrMo2	8620	805M20	362	20NCD2	2506	20NiCrMo2			20CGNM	
1.6546	SNCM240	40NiCrMo2-2	8740	311-Tyre7				40NiCrMo2(KB)			38CGNM	
1.6566		17NiCrMo6-4										
1.6587		17CrNiMo6		820A16		18NCD6		14NiCrMo13				
1.6657		10NiCrMo13-4						14NiCrMo131				
1.7015	SCr415(H)	10Cr3	5015	523M15		12C3				G50150	15C	
1.7033	SCr430(H)	34Cr4	5132	530A32	18B	32C4		34Cr4(KB)		G51300	35C	
1.7035	SCr440(H)	41Cr4	5140	530M40	18	42C4	2245	41Cr4		G51400	40H	
1.7131	SCR415	16MnCr5	5115	527M17		16MCS	2511	16MnCr5		G51150	12KHN2	
1.7139		16MnCr55					2127				18HG	
1.7176	SUP9(A)	55Cr3	5155	527A60	48	55C3	2253	55Cr3			50C GA	
1.7218	SCM420	25CrMo4	4130	CDS110		25CD4	2225	25CrMo4(KB)			20C M	
1.7220	SCM432	34CrMo4	4135	708 A 37		35CD4	2234	34CrMo4			35C M	
1.7223	SNB22-1	41CrMo4	4142					41CrMo4			40C FA	
1.7225	SCM 440 (H)	42CrMo4	4140	708 M 40	42 CrMo 4	42 CD 4	2244	42 CrMo 4	F.1252		38HM	
1.7228		55NiCrMoV6G		823M30	33		2512	653M31				
1.7262	SCM415(H)	15CrMo5				12CD4	2216	12CrMo4				
1.7321		20mOcr4					2625					
1.7335	SCM415(H)	13CrMo4-4	A182-F11	1501-620		15CD4-5	2216	14CrMo45			12C M	
1.7361		32CrMo12		722M24	40B	30CD12	2240	30CrMo12	F.124A			
1.7380		10CrMo9-10	A182F22	1501-622		12CD9-10	2218	12CrMo9			12KH8	

Technical Information

Material Groups

Mat'l No.	JIS	DIN	Material Description			Composition / Structure / Heat Treatment					HB	HRc
			AISI/ASTM/SAE	BS	EN	Annealed					180	10
1.7715		14MoV6-3		1503-660-440				13MoCrV6				
1.8159	SUP 10	50CrV4	6150	735A50	47	50CrV4	2230	50CrV4		G61500	50C GFA	
1.8161		58CrV4										
1.8509	SACM 645	41CrAlMo7	A355A	905M39	41B	40CAD6-12	2940	41CrAlMo7				
1.8523		39CrMoV13-9		897M39	40C			36CrMoV12				

Mat'l No.	JIS	DIN	Material Description			Composition / Structure / Heat Treatment					HB	HRc
			AISI/ASTM/SAE	BS	EN	Quenched & Tempered					275	29
1.5415	STFA 12	15Mo3	A204GrA	1503-243B		15D3	2912	16Mo3(KG)	F2601	K11820		
1.5423	SB450M	16Mo5	4520	1503-245-420				16Mo5(KG)	F2602	K11522		
1.5622		14Ni6	A350-LF5			16N6		14Ni6(KG)	F2641			
1.5732	SNC415(H)	14NiCr10	3415			14NC11		16NiCr11				
1.5752	SNC815(H)	14NiCr14	3310	655M13	36A	12NC15					20X2H4A	
1.5755	SNC236	31NiCr14		653M31		18NC13	2534		F.1270			
1.6565	SNCM447	40NiCrMo6	4340	817M40	24	35NCD6	2541	35NiCrMo6(KB)			38C 2N2MA	
1.6587		17CrNiMo6		820A16		18NCD6		14NiCrMo13				
1.6657		10NiCrMo13-4						14NiCrMo131				
1.6957		26NiCrMoV14-5										
1.7015	SCr415(H)	10Cr3	5015	523M15		12C3				G50150	15C	
1.7262	SCM415(H)	15CrMo5				12CD4	2216	12CrMo4				
1.7335	SCM415(H)	13CrMo4-4	A182-F11	1501-620		15CD4-5	2216	14CrMo45			12C M	
1.7380		10CrMo9-10	A182F22	1501-622		12CD9-10	2218	12CrMo9			12KH8	
1.7715		14MoV6-3		1503-660-440				13MoCrV6				
1.7733		24CrMoV55				20CDV6		21CrMoV511				
1.7755		G5-45CrMoV10-4										
1.8070		21CrMoV511						35NiCr9				

Mat'l No.	JIS	DIN	Material Description			Composition / Structure / Heat Treatment					HB	HRc
			AISI/ASTM/SAE	BS	EN	Quenched & tempered					300	32
1.1730		C45W3	C45W			XC48						
1.2332	SCM(440)	47CrMo4	4142	708M40	19A	42CD4	2244	42CrMo4				
1.5736	SNC 631 (H)	36NiCr10	3435			30NC11						
1.6523	SNCM220(H)	21NiCrMo2	8620	805M20	362	20NCD2	2506	20NiCrMo2			20C GNM	
1.7033	SCr430(H)	34Cr4	5132	530A32	18B	32C4		34Cr4(KB)		G51300	35C	
1.7218	SCM420	25CrMo4	4130	CDS110		25CD4	2225	25CrMo4(KB)			20C M	
1.8515		32CrMo12		722M24	40B	30CD12	2240	32CrMo12	F.124A			

Technical Information

Material Groups

TURNING

PARTING & GROOVING

MILLING

DRILLING

TECHNICAL INFORMATION

Mat'l No.	JIS	DIN	Material Description			Composition / Structure / Heat Treatment					HB	HRC
			AISI/ASTM/SAE	BS	EN	Quenched & Tempered					350	38
1.0904	SKH 1, SKT 4	55Si7	9255	250A53	45	55S7	2085	55Si8		G92550	55S2	
1.0961	SUP 7	60SiCr7	9262			60SC6		60SiCr8		G92620		
1.2067		100Cr6	L3	BL3		Y100C6		100Cr6				
1.2419	SKS31	105WCr6		105WC13		105WC13	2140	10WCr6			CWG	
1.2542		45WCrV7	S1	BS1			2710	45WCrV8KU			5CW25F	
1.2713	SKT4	55NiCrMoV6	L6			55NCDV7			F5205		5C NM	
1.4882		X50CrMnNiNbN219				Z50CMNNb21-09						
1.5120		38MnSi4										
1.5710	SNC236	36NiCr6	3135	640A35	111A	35NC6						
1.5755	SNC236	31NiCr14		830m31		18NC13	2534		F1270			
1.6511	SUP10	36CrNiMo4	9840	816M40	110	40NCD3		36NiCrMo4(KB)			40CN2MA	
1.6546	SNCM240	40NiCrMo2-2	8740	311-Tyre7				40NiCrMo2(KB)			38C GNM	
1.7035	SCR440(H)	41Cr4	5140	530M40	18	42C4	2245	41Cr4		G51400	40H	
1.7176	SUP9(A)	55Cr3	5155	527A60	48	55C3	2253	55Cr3			50C GA	
1.7220	SCM432	34CrMo4	4135	708Aa37		35CD4	2234	34CrMo4			35CM	
1.7223	SNB22-1	41CrMo4	4142					41CrMo4			40CFA	
1.7225	SCM 440 (H)	42CrMo4	4140	708 M 40	42 CrMo 4	42 CD 4	2244	42 CrMo 4	F1252		38HM	
1.7361		32CrMo12		722M24	40B	30CD12	2240	30CrMo12	F124A			
1.8159	SUP 10	50CrV4	6150	735A50	47	50CrV4	2230	50CrV4	51CrV4	G61500	50C GFA	
1.8161		58CrV4										
1.8509	SACM 645	41CrAlMo7	A355A	905M39	41B	40CAD6-12	2940	41CrAlMo7				
1.8523		39CrMoV13-9		897M39	40C			36CrMoV12				

Mat'l No.	JIS	DIN	Material Description			Composition / Structure / Heat Treatment					HB	HRC
			AISI/ASTM/SAE	BS	EN	Annealed					200	15
1.0347	SPCD	RR St 3	A619	CR 3	Fe P03	F 13		DC03/FeP03			08JU	
1.0723	SUM32	15S22		210A15			1922		F210F			
1.2080	SKD1	X210Cr12	D3	BD3	X210Cr12	Z200C12		X205Cr12KU		T30403	KH12	
1.2162	SCR 420 H	21MnCr5				20MCS						
1.2311		40CrMnMo7				40CMD8		35CrMo8KU				
1.2312		40CrMnMoS8.6	P20+S			40CMD8S						
1.2316		X36CrMo17			X38CrMo16							
1.2343	SKD 6	X38CrMoV5-1	H11	BH11		Z38CDV5		X37CrMoV51KU		T20811	4C5MFS	
1.2344	SKD61	X40CrMoV5-1	H13	BH13		Z40CDV5	2242	X40CrMoV511KU	F5318	T20813	4C5MF1S	
1.2363	SKD12	X100CrMoV5-1	A2	BA2		Z100CDV5	2260	X100CrMoV51KU	F5227		9KH5VF	
1.2379	SKD11	X155CrVMo121	D2	BD2		Z160CDV12	2310	X165CrMoW12KU		T30402	KH12MF	KRUPP2379
1.2436	SKD 2	X210CrW12	D4(D6)	BD6		Z200CD12	2312	X215CrW121KU	F5213		KH12	

NEXT PAGE ►

Technical Information

Material Groups

Mat'l No.	JIS	DIN	AISI/ASTM/SAE	BS	EN	Composition / Structure / Heat Treatment					HB	HRC
						AFNOR	SS	UNI	UNE / IHA	UNS	GOST	Brands
<div style="display: flex; justify-content: space-between; align-items: center;"> <div style="font-size: 2em; font-weight: bold; color: blue;">P</div> <div style="text-align: center;"> VDI 3323 10 </div> <div style="text-align: center;"> Material Description High-alloyed steel, and tool steel </div> <div style="text-align: center;"> Composition / Structure / Heat Treatment Annealed </div> <div style="text-align: center;"> HB 200 </div> <div style="text-align: center;"> HRC 15 </div> </div>												
1.2510	SKS3	100MnCrW4	O1	BO1		90MWCV5	2140	95MnWCr5KU	F5220		9KHVG	
1.2581	SKD5	X30WCrV9-3	H21	BH21		Z30WCV9		X30WCrV93KU	F526	T20821	3C2W8F	
1.2601		X165CrMoV12					2310	X160CrMoV12			KH12MF	
1.2606	SKD62	X37CrMoW51	H12	BH12		Z35CWDV5		X35CrMoW05KU	F537	T20812	5CNM	
1.2764		X19NiCrMo4										
1.2767		X45NiCrMo4				45NCD16		40NiCrMoV8KU				
1.2842		90MnCrV8	O2	B02		90MV8		90MnVCr8KU		T31502	9G2F	
1.3243	SKH55	S6-5-2-5	T15			KCV06-05-05-04-02	2723	H56-5-2-5			R6M5K5	
1.3249	SKH3	S18-1-2-5	T4	BT4		Z80WKCV18-05-04					R18K5F2	
1.3343	SKH51, SKH9	S6-5-2	M2	BM2		Z85WDCV	2722	H5652	F5604		R6M5	
1.3348	SKH58	S2-9-2	M7			Z100DCWV09-04-02	2782	HS292	F5607			
1.3355	SKH2	S18-0-1	T1	BT1		Z80WCV18-4-01					R18	
1.4718	SUH1	X45CrSi9-3	HNV3	401S45	52	Z45CS9		X45CrSi8	F322		40C952	
1.5662	SL9N60(53)	X8Ni9	ASMA353	502-650		9Ni		X10Ni9	F2645			
1.5680		12Ni19	2515	12Ni19		Z18N5						

Mat'l No.	JIS	DIN	AISI/ASTM/SAE	BS	EN	Composition / Structure / Heat Treatment					HB	HRC
						AFNOR	SS	UNI	UNE / IHA	UNS	GOST	Brands
<div style="display: flex; justify-content: space-between; align-items: center;"> <div style="font-size: 2em; font-weight: bold; color: blue;">P</div> <div style="text-align: center;"> VDI 3323 11 </div> <div style="text-align: center;"> Material Description High-alloyed steel, and tool steel </div> <div style="text-align: center;"> Composition / Structure / Heat Treatment Quenched & Tempered </div> <div style="text-align: center;"> HB 325 </div> <div style="text-align: center;"> HRC 35 </div> </div>												
1.2080	SKD1	X210Cr12	D3	BD3	X210Cr12	Z200C12		X205Cr12KU		T30403	KH12	
1.2344	SKD61	X40CrMoV5-1	H13	BH13		Z40CDV5	2242	X40CrMoV511KU	F5318	T20813	4C5MF15	
1.2363	SKD12	X100CrMoV5-1	A2	BA2		Z100CDV5	2260	X100CrMoV51KU	F5227		9KH5VF	
1.2436	SKD2	X210CrW12	D4(D6)	BD6		Z200CD12	2312	X215CrW121KU	F5213		KH12	
1.2581	SKD5	X30WCrV9-3	H21	BH21		Z30WCV9		X30WCrV93KU	F526	T20821	3C2W8F	
1.2601		X165CrMoV12					2310	X160CrMoV12			KH12MF	
1.2714	SKT4	55NiCrMoV7	6F3/L6			55NiCrMoV7			F5205		SKHNV	
1.3202		S12-1-4-5		BT15				HS12-1-5-5				
1.3207		S10-4-3-10		BT42		Z130WKCDV						
1.3243	SKH55	S6-5-2-5	T15			KCV06-05-05-04-02	2723	H56-5-2-5			R6M5K5	
1.3246		S7-4-2-5	M35			Z110WKCDV07-05-04		HS7-4-2-5				
1.3247	SKH51	S2-10-1-8	M42	BM42		Z110DKCV09-08-04		HS2-9-1-8			R2AM9K5	
1.3255	SKH3	S18-1-2-5	T4	BT4		Z80WKCV18-05-04					R18K5F2	
1.3343	SKH51, SKH9	S6-5-2	M2	BM2		Z85WDCV	2722	H5652	F5604		R6M5	
1.3348	SKH58	S2-9-2	M7			Z100DCWV09-04-02	2782	HS292	F5607			
1.3355	SKH2	S18-0-1	T1	BT1		Z80WCV18-4-01					R18	
1.4718	SUH1	X45CrSi9-3	HNV3	401S45	52	Z45CS9		X45CrSi8	F322		40C952	
1.4935	SUH616	X20CrMoWV121	422							S42200		
1.5680		12Ni19	2515	12Ni19		Z18N5						

Technical Information

Material Groups

TURNING

PARTING & GROOVING

MILLING

DRILLING

TECHNICAL INFORMATION

M		VDI 3323 12		Material Description			Composition / Structure / Heat Treatment					HB	HRC
				Stainless steel			Ferritic / Martensitic, Annealed					200	15
Mat'l No.	JIS	DIN	AISI/ASTM/SAE	BS	EN	AFNOR	SS	UNI	UNE / IHA	UNS	GOST	Brands	
1.4000	SUS403	X6Cr13	403	403S17		Z6C13	2301	X6Cr13	F3110	S40300	08C 13	ATI410S	
1.4001		X7Cr14	410S	403S7		Z8C13	2301		F8401		08C 13		
1.4002	SUS 405	X6CrAl13	405	405S17		Z6CA13	2302	X6CrAl13		S40500			
1.4005	SUS416	X12CrS13	416	416S21		Z11CF13	2380	X12CrS13	F3411	S41600		ATI416	
1.4006	SUS410	X12Cr13	410	410S21	56A	Z10C13	2302	X12Cr13	F3401	S41000	12C 13	ATI410	
1.4016	SUS430	X6Cr17	430	430S15	X8Cr17	Z8C17	2320	X8Cr17	F3113	S43000	12C 17	ATI430	
1.4027	SCS 2	GX20Cr14		420C29		Z20C13M					20C 13L		
1.4028	SUS420J2	X30Cr13	420	420S45		Z30C13	2304			S42020	20C 13		
1.4034	SUS420J2	X46Cr13		420S45		Z40C14		X40Cr14	F3405				
1.4057	SUS431	X19CrNi17-2	431	431S29	57	Z15CN16-02	2321	X16CrNi16	F3427	S43100	20C 17N2	431 (HT)	
1.4086		GX120Cr29		452C11									
1.4104	SUS430F	X12CrMoS17	430F	420S37		Z10CF17	2383	X10CrS17	F3117	S43020			
1.4112	SUS 440 B	X90CrMoV18	440B							S44003	95KH18		
1.4113	SUS434	X6CrMo17	434	434S17		Z8CD17-01	2325	X8CrMo17		S43400		AL 434	
1.4313	SCS5	X3CrNi13-4	CA6-NM	425C11		Z4CND13-04M	2385	(G)X6CrNi304		J91540			
1.4340		GX40CrNi274								J92615			
1.4417		X2CrNiMoSi195	S31500				2376			S39215			
1.4418		X4CrNiMo165				Z6CND16-04-01	2387					APX4	
1.4510	SUS430LX	X6CrTi17	XM8			Z4CT17		X6CrTi17	F3115	S43035	08C 17T	430 Ti	
1.4511	SUS430LK	X6CrNb17				Z4CNb17		X6CrNb17	F3122			AXC525	
1.4512	SUH409	X6CrTi12	409	LW19		Z3CT12		X6CrTi12		S40900			
1.4720		X20CrMo13											
1.4724	SUS 405	X10CrAl13	405	403S17		Z10C13		X10CrAl12	F311		10C 13SJU		
1.4742	SUS430	X10CrAl18	430	439S15	60	Z10CAS18		X8Cr17	F3113	S43000	15C 13SJU		
1.4747	SUH4	X80CrNiSi20	H1NV6	443S65	59	Z80CSN20-02		X80CrSiNi20	F320B	S65006			
1.4749		X18CrNi28	446								15KH28		
1.4762	SUH446	X10CrAl124	446			Z10CAS24	2322	X16Cr26		S44600			
1.4871	SUH35,SUH36	X53CrMnNiN21-9	EV8	349S54		Z52CMN21-09		X53CrMnNiN219		S63008	55C 20G9AN4		
		X10CrNi15	429										
		X12CrNi18-9	302	302S31		Z10CN18-09	2330						

M		VDI 3323 13		Material Description			Composition / Structure / Heat Treatment					HB	HRC
				Stainless steel			Martensitic, Quenched & Tempered					240	23
Mat'l No.	JIS	DIN	AISI/ASTM/SAE	BS	EN	AFNOR	SS	UNI	UNE / IHA	UNS	GOST	Brands	
1.4000	SUS403	X6Cr13	403	403S17		Z6C13	2301	X6Cr13	F3110	S40300	08C 13	ATI410S	
1.4001		X7Cr14	410S	403S7		Z8C13	2301		F8401		08C 13		
1.4006	SUS410	X12Cr13	410	410S21	56A	Z10C13	2302	X12Cr13	F3401	S41000	12C 13	ATI410	
1.4016	SUS430	X6Cr17	430	430S15	X8Cr17	Z8C17	2320	X8Cr17	F3113	S43000	12C 17	ATI430	
1.4021	SUS 420J1	X20Cr13	420	420S37		Z20C13	2303	14210	F5261	S42000	20C 13	ATI420	
1.4027	SCS 2	GX20Cr14		420C29		Z20C13M					20C 13L		
1.4031	SUS 420J2	X40Cr13	420			Z40C14	-2304		F3404	S42080	40C 13		
1.4034	SUS420J2	X46Cr13		420S45		Z40C14		X40Cr14	F3405				
1.4057	SUS431	X19CrNi17-2	431	431S29	57	Z15CN16-02	2321	X16CrNi16	F3427	S43100	20C 17N2	431 (HT)	
1.4104	SUS430F	X12CrMoS17	430F	420S37		Z10CF17	2383	X10CrS17	F3117	S43020			
1.4113	SUS434	X6CrMo17	434	434S17		Z8CD17-01	2325	X8CrMo17		S43400		AL 434	
1.4313	SCS5	X3CrNi13-4	CA6-NM	425C11		Z4CND13-04M	2385	(G)X6CrNi304		J91540			
1.4544		A 700	321	S.524		Z 10 CNT 18 11		X6CrNiTi1811		J92630	08C 18N12T		
1.4546		X5CrNiNb18-10	348	347S31				X6CrNiNb1811		J92640		ATI 348	
1.4871	SUH35,SUH36	X53CrMnNiN21-9	EV8	349S54		Z52CMN21-09		X53CrMnNiN219		S63008	55C 20G9AN4		
1.4922		X20CrMnV12-1					2317	x20CrMnOn1201					
1.4923		X22CrMoV121										Jethete X20	

Technical Information

Material Groups

M		VDI 3323		Material Description			Composition / Structure / Heat Treatment					HB	HRC
		14		Stainless steel			Austenitic					180	10
Mat'l No.	JIS	DIN	AISI/ASTM/SAE	BS	EN	AFNOR	SS	UNI	UNE / IHA	UNS	GOST	Brands	
1.4301	SUS 304	X5CrNi18-10	304	304S15		Z5CN18-09	2332		F3551	S30409	08C 18N10		
1.4305	SUS303	X10CrNiS18-10	303	303S21	58M	Z8CNF18-09	2346	X10CrNiS18.09	F3508	S30300	30C 18N11	ATI 303	
1.4306	SCS19	X2CrNi1911	304L	304C12	X3CrNi1810KD	Z2CN18-09	2352	GX2CrNi1910	F3503	S30403	03KH18N11	ATI 304L	
1.4308	SUS304L	GX6CrNi18-9	CF-8	304C15	58E	Z6CN18-10M	2333					CF-8	
1.4310	SUS 301	X10CrNi18-8	301	301S21		Z12CN17-07	2331	X2CrNi1807	F3517	S30100	07KH16N6	ATI 301	
1.4311	SUS304LN	X2CrNiN18 10	304LN	304S62		Z2CN18-10	2371	X2CrNiN1810	F3541	S30453	03KH18N11		
1.4312	SCS12	GX10CrNi188	305	302C25		Z10CN18-9M					10C 18N9L	ATI 305	
1.4350	SUS304	X5CrNi18-9	304	304S15	58E	Z6CN18-09	2332	X5CrNi1810	F3551	S30400		ATI 304	
1.4362		X2CrNiN234	S32304			Z2CN23-04AZ	2327			S32304		ATI 2304TM	
1.4371		X3CrMnNiN18887	202	284S16		Z8CMN18-08-05							
1.4401	SUS316	X5CrNiMo17-12-2	316	316S13		Z3CND17-11-01	2347	X5CrNiMo17 12 2	F3534	S31600	08KH17H13M2T	ATI 316	
1.4404	SUS316L	X2CrNiMo17-13-2	316L	316S11		Z2CND17-12	2348	X2CrNiMo1712	F3533	S31603		ATI 316L	
1.4406	SUS316LN	X2CrNiMoN17122	316LN	316S61		Z2CND17-12AZ		X2CrNiMoN1712	F3542	S31653	07C 18N	ATI 316LN	
1.4408	SCS14	GX6CrNiMo18-10	CF-8M	316C16			2343	X7CrNiMo2010	F8414	J92900	10G2S2MSL		
1.4410	SCS 14 A	GX10CrNiMo18-9				Z5CND20-12M	2328			S32750			
1.4429	SUS316LN	X2CrNiMoN17-13-3	316Ln	316S62		Z2CND17-13AZ	2375	X2CrNiMoN17133	F3543		03KH16N15M3		
1.4435	SUS316L	X2CrNiMo18143	316L	316S11		Z3CND17-12-03	2375	X2CrNiMo17 13 2	F3533	S31603	03C 17N14M3		
1.4436	SUS316	X3CrNiMo17-13-3	316	316S19		Z6CND18-12-03	2343	X5CrNiMo17 12 2	F3543	S31600			
1.4438	SUS317L	X2CrNiMo18164	317L	317S12		Z2CND19-15-04	2367	X2CrNiMo18 16 4	F3539	S31703		ATI 317L	
1.4439		X2CrNiMoN17135	(s31726)			Z3CND18-14-06AZ							
1.4440		X2CrNiMo18-16											
1.4449	SUS317	X5CrNiMo17133	317	317S16				X5CrNiMo1815		S31700		ATI 317	
1.4460	SUS 329 J1	X8CrNiMo275	329				2324			S32900		10RE51	
1.4462	SUS329J3L	X2CrNiMoN2253		318S13		Z3CND22-05Az	2377			S31803		ATI 2205TM	
1.4500		X7NiCrMoCuNb2520				Z3NCUDU25-20M				J95150			
1.4521	SUS444	X2CrMoTi18-2	443444				2326	X2CrMoTiNb18 2	F3123				
1.4539		X1NiCrMoCuN25205				Z2NCUDU25-20	2562			N08904		ATI 904L	
1.4541	SUS321	X14CrNiTi18-10	321	321S31		Z6CNT18-10	2337	X6CrNiTi18 11	F3523	S32100	06C 18N10T	ATI 321	
1.4542	SUS630	X5CrNiCuNb174	630			Z7CNU15-05						UGIMA 4542	
1.4545		Z7CNU15.05	15-5PH							S15500		ATI 15-5	
1.4547		X1CrNiMoN20187	S31254				2378			S31254		Uranus B256Mo	
1.4550	SUS347	X6CrNiNb18-10	347	347S17	58F	Z6CNNb18-10	2338	X6CrNiNb 18 11	F3552	S34700	08C 18N12B	ATI 347	
1.4552	SCS 21	GX7CrNiNb18-9				Z4CNNb19-10M				J92710			
1.4568	SUS 631	X 7 CrNiAl 17 7		316S111		Z9 CAN 17-7	2388	Z8CNA17-07		S17700	09C 17NUJ1	17-7PH	
1.4571	SUS 316Ti	X6CrNiMoTi17-12-2	316Ti	320S31	58J	Z6NDT17-12	2350	X6CrNiMoTi17 12	F3535		10C 17N13M2T	ATI 316Ti	
1.4581	SCS 22	GX5CrNiMoNb18		318C17		Z4CNDNb18-12M							
1.4583		X6CrNiMoNb18-12	318	303S21		Z15CNS20-12		X15CrNiSi2 12					
1.4585		GX7CrNiMoCuNb1818						X6CrNiMoTi17 12		J94651			
1.4821		X20CrNiSi254				Z20CNS25-04				S44635			
1.4823		GX40CrNiSi274								J92605			
1.4828	SCS17	X15CrNiSi20-12	309	309S24	58C	Z15CNS20-12			F8414	S30900	20C 20N14S2	ATI 309	
1.4833	SUS 309 S	X6CrNi2213	309S	309S13		Z15CN24-13				J93400			
1.4845	SUH310	X12CrNi25-21	310S	310S24		Z12CN25-20	2361	X6CrNi2520	F331	S31008	20C 23N18	ATI 310S	
1.4878	SUS321	X12CrNiTi18-9	321	321S20	58B	Z6CNT18-12(B)	2337	X6CrNiTi1811	F3553	S32100		ACX315	
1.4891		X5CrNiNb18-10	Ss30415				2372						
1.4893		X8CrNiNb11	S30815				2368						
1.4948		X6CrNi1811	304H	304S51		Z5CN18-09	2333			S30480			
1.4980		X5NiCrTi2515	660				2570			S66286		Incoloy A 286	
		X5NiCrN3525											
		X2CrNiMoN18134	S31753										
		X2CrNiMoN25227											

Technical Information

Material Groups

TURNING

PARTING & GROOVING

MILLING

DRILLING

TECHNICAL INFORMATION

K		VDI 3323 15		Material Description			Composition / Structure / Heat Treatment					HB	HRC
				Grey cast iron			Pearlitic / Ferritic					180	10
Mat'l No.	JIS	DIN	AISI/ASTM/SAE	BS	EN	AFNOR	SS	UNI	UNE / IHA	UNS	GOST	Brands	
0.6010	FC100	GG10	A48 20 B	Grade 100	GJL-100	Ft 10 D	0100	G10	FG10		Sc 10		
0.6015	FC150	GG15	A48 25 B	Grade 150	GJL-150	Ft 15 D	0115	G15	FG15		Sc 15		
0.6020	FC200	GG20	A48 30 B	Grade 220	GJL-200	Ft 20 D	0120	G20	FG20	W06020	Sc 20		
0.6025	FC250	GG25	A48 40 B	Grade 260	GJL-250	Ft 25 D	0125	G25	FG25		Sc 25		
0.6660		GGL-NiCr 20 2	1050/700/7	Grade F2	GJLA-XNiCr 20-2	L-NC 202	0523	-		F41002		Ni-Resist 2	
1.4449	SUS317	X5CrNiMo17133	317	317S16				X5CrNiMo1815		S31700		ATI317	

K		VDI 3323 16		Material Description			Composition / Structure / Heat Treatment					HB	HRC
				Grey cast iron			Pearlitic (Martensitic)					260	26
Mat'l No.	JIS	DIN	AISI/ASTM/SAE	BS	EN	AFNOR	SS	UNI	UNE / IHA	UNS	GOST	Brands	
0.6025	FC250	GG25	A48 40 B	Grade 260	GJL-250	Ft 25 D	0125	G25	FG25		Sc 25		
0.6030	FC300	GG30	A48 45 B	Grade 300	GJL-300	Ft 30 D	0130	G30	FG30		Sc 30		
0.6035	FC350	GG35	A48 50 B	Grade 350	GJL-350	Ft 35 D	0135	G35	FG35		Sc 35		
0.6040	FC400	GG40	A48 60 B	Grade 400	GJL-400	Ft 40 D	0140	G40	FC40		Sc 40		

K		VDI 3323 17		Material Description			Composition / Structure / Heat Treatment					HB	HRC
				Nodular cast iron			Ferritic					160	3
Mat'l No.	JIS	DIN	AISI/ASTM/SAE	BS	EN	AFNOR	SS	UNI	UNE / IHA	UNS	GOST	Brands	
0.7033	FCD350-22L	GGG35.3	-	350/22L40	GJS-350-22LT	FGS 370-17	0717-15	-					
0.7040	FCD400	GGG40	60-40-18	SNG 420-12	GJS-400-15	FCS 400-12	0717-02	GS 400-12	FG E38-17	F32800	Vc 42-12		
0.7043	FCD 370	GGG40.3	60-40-18	SNG 370-17	GJS-400-18-LT	FGS 370-17	0717-12	GSO 42-17			Vc 42-12		
0.6040	FC400	GG40	A48 60 B	Grade 400	GJL-400	Ft 40 D	0140	G40	FC40		Sc 40		

K		VDI 3323 18		Material Description			Composition / Structure / Heat Treatment					HB	HRC
				Nodular cast iron			Pearlitic					250	25
Mat'l No.	JIS	DIN	AISI/ASTM/SAE	BS	EN	AFNOR	SS	UNI	UNE / IHA	UNS	GOST	Brands	
0.7050	FCD500	GGG50	80-55-06	SNG 500-7	GJS-500-7	FGS 500-7	0727-02	GS 500-7	FG E50-7	F33100	Vc 50-2		
0.7060	FCD600	GGG60	80-55-06	SNG 600-3	GJS-600-3	FGS 600-3	0732-03	GS 600-3	FG E60-2		Vc 60-2		
0.7070	FCD700	GGG70	100-70-03	SNG 700-2	GJS-700-2	FGS 700-2	0737-01	GS 700-2	FG S70-2	F34800	Vc 70-2		
0.7652	FCDA-NiMn 137	GGG NiMn 13-7	-	Grade S6	GJSA-XNiMn 13-7	FGS Ni13 Mn7	0772	-				Nodumag	
0.7660		GGG NiCr 20-2	A436 D2	Grade S2	GJSA-XNiCr 20-2	FGS Ni20 Cr2	0776	-				Ni-Resist D-2	

Technical Information

Material Groups

K	VDI 3323		Material Description				Composition / Structure / Heat Treatment				HB	HRC
	19		Malleable cast iron				Ferritic				130	
Mat'l No.	JIS	DIN	AISI/ASTM/SAE	BS	EN	AFNOR	SS	UNI	UNE / IHA	UNS	GOST	Brands
0.8135	FCMW330	GTS-35	32510	B 340-12	GJMB350-10	MN 35-10	0815	GMN 35	GTS35		Kc 35-10	

K	VDI 3323		Material Description				Composition / Structure / Heat Treatment				HB	HRC
	20		Malleable cast iron				Pearlitic				230	21
Mat'l No.	JIS	DIN	AISI/ASTM/SAE	BS	EN	AFNOR	SS	UNI	UNE / IHA	UNS	GOST	Brands
0.8145	FCMW370	GTS-45	A220-40010	P 440-7	GJMB450-6	MN 450	0852	GMN 45				
0.8155	FCMP490	GTS-55	50005	P 510-4	GJMB-550-4	MP 50-5	0854	GMN 55			Kc 60-3	
0.8165	FCMP590	GTS-65	70003	P 570-3	GJMB-650-2	MN 650-3	0856	GMN 65				
0.8170	FCMP690	GTS-70	90001	P 690-2	GJMB-700-2	MN 700-2	0862	GMN 70			Kc 70-2	

TURNING

PARTING & GROOVING

MILLING

DRILLING

TECHNICAL INFORMATION

Technical Information

Material Groups

TURNING

PARTING & GROOVING

MILLING

DRILLING

TECHNICAL INFORMATION

N		VDI 3323 21	Material Description			Composition / Structure / Heat Treatment					HB	HRc
			Aluminum-wrought alloy			Not Curable					60	
Mat'l No.	JIS	DIN	AISI/ASTM/SAE	BS	EN	AFNOR	SS	UNI	UNE / IHA	UNS	GOST	Brands
3.0205		Al99	Al99									
3.0255	(A1050)	Al99.5	1000	L31		A59050C					D1	
3.3315		AlMg1										

N		VDI 3323 22	Material Description			Composition / Structure / Heat Treatment					HB	HRc
			Aluminum-wrought alloy			Curable, Hardened					100	
Mat'l No.	JIS	DIN	AISI/ASTM/SAE	BS	EN	AFNOR	SS	UNI	UNE / IHA	UNS	GOST	Brands
3.1325		AlCuMg1									AD35	
3.1655	A2011	AlCuSiPb										
3.2315		AlMgSi1									AK9	
3.4345		AlZnMgCu0,5	7050	L86		AZ4GU/9051		811-04				
3.4365	7075	AlZnMgCu1,5	7075	7075		7075		AlZn5.8MgCuCr			B95	

N		VDI 3323 23	Material Description			Composition / Structure / Heat Treatment					HB	HRc
			Aluminum-cast, alloyed			≤ 12% Si, Not Curable					75	
Mat'l No.	JIS	DIN	AISI/ASTM/SAE	BS	EN	AFNOR	SS	UNI	UNE / IHA	UNS	GOST	Brands
3.2163		G-AlSi9Cu3									VAL8	
3.2382		GD-AlSi10Mg										
3.2383		G-AlSi0Mg(Cu)	A360.2	LM9			4253					
3.2581		G-AlSi12										
3.3561		G-AlMg5										
3.5101		G-MgZn4sE1Zr1	ZE41	MAG5								
3.5103		MgSE3Zn27r1	EZ33	MAG6		G-TR3Z2						
3.5812		G-MgAl8Zn1	AZ81	NMAG1								
3.5912		G-MgAl9Zn1	AZ91	MAG7								
			A356-72	2789		NFA32-201						
A5052			356.1	LM25			4244				AK7	
		G-AlSi12	A413.2	LM6			4261					
ADC12		G-AlSi12(Cu)	A413.1	LM20			4260				AK12	
A6061		GD-AlSi12	A413.0				4247					
A7075		GD-AlSi8Cu3	A380.1	LM24			4250					

Technical Information

Material Groups

Mat'l No.	JIS	DIN	AISI/ASTM/SAE	BS	EN	Composition / Structure / Heat Treatment					HB	HRc		
						AFNOR	SS	UNI	UNE / IHA	UNS	GOST	Brands		
		N		VDI 3323 24		Material Description Aluminum-cast, alloyed					Composition / Structure / Heat Treatment ≤ 12% Si, Curable, Hardened		90	
2.1871		G-AlCu4TiMg												
3.1754		G-AlCu5Ni1,5												
3.2371		G-AlSi7Mg	4218B									AK8		
3.2373	C4BS	G-AlSi9MgWA	SC64D			A-57G	4251					AK9		
3.2381		G-AlSi10Mg										AK12		
3.5106		G-MgAg3SE2Zr1	QE22	mag12										
		G-ALMG5	GD-AISI12	LM5		A-SU12	4252							

Mat'l No.	JIS	DIN	AISI/ASTM/SAE	BS	EN	Composition / Structure / Heat Treatment					HB	HRc		
						AFNOR	SS	UNI	UNE / IHA	UNS	GOST	Brands		
		N		VDI 3323 26		Material Description Copper and Copper Alloys (Bronze / Brass)					Composition / Structure / Heat Treatment Cutting alloys, PB>1%		110	
2.0375		CuZn36Pb3										LS60-2		
2.1090		G-CuSn75pb	C93200			U-E7Z5pb4								
2.1096		G-CuSn5ZnPB	c83600	LG2										
2.1098		G-CuSn2Znpb	C83600											
2.1182		G-CuPb15Sn	C23000	LB1		U-pb15EB								

Mat'l No.	JIS	DIN	AISI/ASTM/SAE	BS	EN	Composition / Structure / Heat Treatment					HB	HRc		
						AFNOR	SS	UNI	UNE / IHA	UNS	GOST	Brands		
		N		VDI 3323 27		Material Description Copper and copper alloys (Bronze / Brass)					Composition / Structure / Heat Treatment CuZn, CuSnZn (Brass)		90	
2.0240	C2300	CuZn15										L90		
2.0321		CuZn37	C27200	c2108		CuZn36,CuZn37		C2700				L63		
2.0590		G-CuZn40Fe												
2.0592		G-CuZn35Al1	C86500	U-Z36N3		HTB1								
2.0596		G-CuZn34Al2	C86200	HTB1		U-Z36N3						LTs23AD		
2.1293		CuCrZr	C18200	CC102		U-Cr0-8Zr								

Mat'l No.	JIS	DIN	AISI/ASTM/SAE	BS	EN	Composition / Structure / Heat Treatment					HB	HRc		
						AFNOR	SS	UNI	UNE / IHA	UNS	GOST	Brands		
		N		VDI 3323 28		Material Description Copper and copper alloys (Bronze / Brass)					Composition / Structure / Heat Treatment CuSn, lead-free copper and electrolytic copper		100	
2.0060		E-Cu57												
2.0966		CuAl10Ni5Fe4	C63000	Ca104		U-A10N						BrAD		
2.0975		G-CuAl10Ni	B-148-52											
2.1050		G-CuSn10	c90700	CT1										
2.1052		G-CuSn12	C90800	pb2		UE12P								
2.1292		G-CuCrF35	C81500	CC1-FF										

Technical Information

Material Groups

TURNING

PARTING & GROOVING

MILLING

DRILLING

TECHNICAL INFORMATION

Mat'l No.	JIS	DIN	Material Description			Composition / Structure / Heat Treatment					HB	HRc
			AISI/ASTM/SAE	BS	EN	AFNOR	SS	UNI	UNE / IHA	UNS	GOST	Brands
<div style="display: flex; justify-content: space-between; align-items: center;"> <div style="font-size: 2em; font-weight: bold; color: #e67e22;">S</div> <div style="text-align: center;"> VDI 3323 31 </div> <div style="text-align: center;"> Material Description Heat resistant super alloys </div> <div style="text-align: center;"> Composition / Structure / Heat Treatment Fe Based, Annealed </div> <div style="text-align: center;"> HB 200 </div> <div style="text-align: center;"> HRc 15 </div> </div>												
1.4558	NCF 800TB	X2NiCrAlTi3220	N08800	NA15								
1.4562		X1NiCrMoCu32287	N08031									
1.4563		X1NiCrMoCuN31274	N08028			Z1NCU31-27-03	2584				EK77	
1.4864	SUH330	X12NiCrSi36-16	330	NA17		Z12NCS37-18					N08330	
1.4865	SCH15	GX40NiCrSi38-18		330C40				XG50NiCr3919			J94605	
1.4958		X5NiCrAlTi3120										

Mat'l No.	JIS	DIN	Material Description			Composition / Structure / Heat Treatment					HB	HRc
			AISI/ASTM/SAE	BS	EN	AFNOR	SS	UNI	UNE / IHA	UNS	GOST	Brands
<div style="display: flex; justify-content: space-between; align-items: center;"> <div style="font-size: 2em; font-weight: bold; color: #e67e22;">S</div> <div style="text-align: center;"> VDI 3323 32 </div> <div style="text-align: center;"> Material Description Heat resistant super alloys </div> <div style="text-align: center;"> Composition / Structure / Heat Treatment Fe Based, Aged </div> <div style="text-align: center;"> HB 280 </div> <div style="text-align: center;"> HRc 30 </div> </div>												
1.4977		X40CoCrNi2020				Z42CNKDWNb						

Mat'l No.	JIS	DIN	Material Description			Composition / Structure / Heat Treatment					HB	HRc
			AISI/ASTM/SAE	BS	EN	AFNOR	SS	UNI	UNE / IHA	UNS	GOST	Brands
<div style="display: flex; justify-content: space-between; align-items: center;"> <div style="font-size: 2em; font-weight: bold; color: #e67e22;">S</div> <div style="text-align: center;"> VDI 3323 33 </div> <div style="text-align: center;"> Material Description Heat resistant super alloys </div> <div style="text-align: center;"> Composition / Structure / Heat Treatment Ni or Co Based, Annealed </div> <div style="text-align: center;"> HB 250 </div> <div style="text-align: center;"> HRc 25 </div> </div>												
2.4360		NiCu30Fe		NA13		NU30					N04400	Monel400
2.4603		NiCr 30 FeMo	5390A			NC22FeD						Hastelloy G-30
2.4610		NiMo16Cr16Ti									N26455	HastelloyC-4
2.4630		NiCr20Ti		HR5,203-4		NC20T					N06075	Nimonic75
2.4631	NCF 80A	NiCr20TiAl		HR40		NC20TA					N07080	KHN77TYuR Nimonic 80A
2.4642	NCF 690	NiCr29Fe				Nnc30Fe					N06690	Inconel 690
2.4856		NiCr22Mo9Nb		NA21		NC22FeDNb					N06625	Inconel 625
2.4858		NiCr21Mo		NA16		NC21FeDU					N08825	KHN38VT Incoloy 825

Mat'l No.	JIS	DIN	Material Description			Composition / Structure / Heat Treatment					HB	HRc
			AISI/ASTM/SAE	BS	EN	AFNOR	SS	UNI	UNE / IHA	UNS	GOST	Brands
<div style="display: flex; justify-content: space-between; align-items: center;"> <div style="font-size: 2em; font-weight: bold; color: #e67e22;">S</div> <div style="text-align: center;"> VDI 3323 34 </div> <div style="text-align: center;"> Material Description Heat resistant super alloys </div> <div style="text-align: center;"> Composition / Structure / Heat Treatment Ni or Co Based, Aged </div> <div style="text-align: center;"> HB 350 </div> <div style="text-align: center;"> HRc 38 </div> </div>												
2.4375		NiCu30Al	4676	NA18		NU30AT					N05500	MonelK500
2.4662		NiFe35Cr14MoTi	5660			ZSNCDT42					N09901	Incoloy 901
2.4668		NiCr19Fe19NbMo	5383	HR8		NC19eNB					N07718	Inconel 718
2.4670		S-NiCr13Al16MoNb	5391	Mar-46		NC12AD						Nimocast 713
2.4694		NiCr16Fe7TiAl									N07751	Inconel 751
2.4955		NiFe25Cr20NbTi										
2.4964		CoCr20W15Ni	5772			KC20WN						Haynes 25
		CoCr22W14Ni	AMS 5772			KC22WN						

Technical Information

Material Groups

S		VDI 3323 35		Material Description Heat resistant super alloys			Composition / Structure / Heat Treatment Ni or Co Based, Cast					HB 320	HRC 34
Mat'l No.	JIS	DIN	AISI/ASTM/SAE	BS	EN	AFNOR	SS	UNI	UNE / IHA	UNS	GOST	Brands	
2.4669		NiCr15Fe7TiAl				NC15TNbA				N07750		Inconel X750	
2.4685		G-NiMo28								N10665		Hastelloy B	
2.4810		G-NiMo30										Hastelloy C	
2.4973		NiCr19Co11MoTi	AMS 5399			NC19KDT					VT5-1		
3.7115		TiAl5Sn2								R54520	VT1-00	ATI Grade 6	

S		VDI 3323 36		Material Description Titanium alloys			Composition / Structure / Heat Treatment Pure Titanium					HB 400 Rm	HRC
Mat'l No.	JIS	DIN	AISI/ASTM/SAE	BS	EN	AFNOR	SS	UNI	UNE / IHA	UNS	GOST	Brands	
2.4674		NiCo15Cr10MoAlTi	AMS 5397							N13100		IN 100	
3.7025		Ti1	R50250	2TA1						R50250		ATI 30 CP Gr.1	
3.7225		Ti1pd	R52250	TP1						R52250			

S		VDI 3323 37		Material Description Titanium alloys			Composition / Structure / Heat Treatment Alpha + Beta Alloys, Hardened					HB 1050 Rm	HRC
Mat'l No.	JIS	DIN	AISI/ASTM/SAE	BS	EN	AFNOR	SS	UNI	UNE / IHA	UNS	GOST	Brands	
3.7124		TiCu2		2TA21-24									
3.7145		TiAl6Sn2Zr4Mo2Si	R54620							R54620			
3.7165		TiAl6V4	AMS R56400	TA10-13		T-A6V					VT6		
3.7185		TiAl4Mo4Sn2		TA45-51									
3.7195		TiAl3V2.5								R56320		ATI 3-2.5	
		TiAl4Mo4Sn4Si0.5											
		TiAl5Sn2.5	AMS R54520	TA14/17		T-A5E							
		Ti6Al4VELI	AMS R56401	TA11									

Technical Information

Material Groups

TURNING

PARTING & GROOVING

MILLING

DRILLING

TECHNICAL INFORMATION

H		VDI 3323 38	Material Description				Composition / Structure / Heat Treatment					HB	HRC
			Hardened steel				Hardened					550	55
Mat'l No.	JIS	DIN	AISI/ASTM/SAE	BS	EN	AFNOR	SS	UNI	UNE / IHA	UNS	GOST	Brands	
1.1231	S70 C-CSP	Ck67	1070	060 A67	C675	XC68	1770	C70	F5103		70		
1.1248	C75	Ck75	1078, 1080	060 A78	C75S	XC75	1774	C75	F5107		75		
1.1274	SUP4	Ck101	1095	060 A96	C100S	XC100	1870	C100	F5117				
1.1545	SK3	C105W1	W1	BW2	C105U	Y1105	1880	C100KU	F5118		U10A		
1.2762		75CrMoNiW67	-	-	-	-	-	-	-				
1.3401	SCMnH1	GX120Mn12	A128(A)			Z120M12	2183	GX120Mn12	F8251		110G13L		
1.4021	SUS420J1	X20Cr13	420	420S37	X20Cr13	Z20C13	2303	X20Cr13	F5261		20KH13	ATI420	
1.4109	SUS440A	X65CrMo14	440A	-	X70CrMo15	Z70D14	-	-				ATI440A	
1.4112	SUS440B	X90CrMoV18	440B	409S19	X90CrMoV18	Z2CND1805	2327	XCrTi12					
1.4125	SUS440C	X105CrMo17	440C	-	X105CrMo17	Z100CD17	-	X105CrMo17			95KH18	ATI440C	
1.6746		32NiCrMo14-5	-	832M31	32NiCrMo145	35NCD14	-	-					
1.7176	SUP9(A)	55Cr3	5155	527A60	48	55C3	2253	55Cr3					
1.7225	SCM440(H)	42CrMo4	4140	708M40	42CrMo4	42CD4	2244	42CrMo4	F1252		38HM		

H		VDI 3323 40	Material Description				Composition / Structure / Heat Treatment					HB	HRC
			Chilled cast iron				Cast					400	42
Mat'l No.	JIS	DIN	AISI/ASTM/SAE	BS	EN	AFNOR	SS	UNI	UNE / IHA	UNS	GOST	Brands	
0.9620		GX260NiCr42	A532IB	Grade 2A	GJN-HV520	FBNi4Cr2BC	0512	-		F45001		Ni-Hard2	
0.9625		GX330NiCr42	A532IA	Grade 2B	GJN-HV550	FBNi4Cr2HC	0513	-		F45000		Ni-Hard1	
0.9630		GX300CrNiSi952	A532ID	Grade 2C	GJN-HV600	FBCr9Ni5	0457	-		F45003		Ni-Hard4	
0.9640		GX300CrMoNi1521	-	-	-	-	-	-		F45005			
0.9650		GX260Cr27	-	Grade 3D	-	-	0466	-					
0.9655		GX300CrNiMo271	-	Grade 3E	-	-	-	-			20C25N20S2		
1.4841	SUH310	X15CrNiSi25-20	310	314S31	X15CrNiSi2520	Z15CNS25-20	-	-		S31400		Cronifer 2520	

H		VDI 3323 41	Material Description				Composition / Structure / Heat Treatment					HB	HRC
			Hardened cast iron				Hardened					550	55
Mat'l No.	JIS	DIN	AISI/ASTM/SAE	BS	EN	AFNOR	SS	UNI	UNE / IHA	UNS	GOST	Brands	
0.9635		GX300CrMo153	-	-	-	-	-	-					
0.9645		GX260CrMoNi2021	-	-	-	-	-	-		F45007			

Application Guide
Steel Guide

Grade Recommendation based on Workpiece Material Condition

	<p>Pre Machined Condition No Outer Skin Uniform hardness on material Has stable machining condition</p>	<p>HARD</p> <p>↑</p> <p>YG3115</p> <p>YG3020</p> <p>YG3030</p> <p>↓</p> <p>TOUGH</p>
	<p>Welded Condition Soft / No Outer Skin Weld Bead Could be of Different Hardness than Actual Part Stock on Part could even except weld Seam during Machining causing shock loads</p>	
	<p>Cast Condition Hard Outer Skin Could have Sand Inclusion,- if Green Sand Cast Component could have uneven Stock during machining</p>	
	<p>Hot Rolled Condition Soft / No Outer Skin Usually heat treated before machine to reduce Hardness Component could have uneven Stock During Machining</p>	
	<p>Forged Condition Soft Outer Skin Usually heat treated before machine to reduce Hardness Component could have uneven Stock during machining</p>	

Chipbreaker, Feed Rate and Depth of Cut

		Sharp Edge	General	Strong Edge
	Continuous			
	General			
	Heavy Interrupt			

Application Guide

Steel Guide

TURNING

PARTING & GROOVING

MILLING

DRILLING

TECHNICAL INFORMATION

P										
Non Alloy Steel, About 0.15% C (Low Carbon Steel)										
VDI	JIS	DIN	Mat'l No.	AISI/ASTM	SS	AFNOR	UNI	UNE	BS	GOST
1	S15C	CK15	1.0401	1015	1350	XC18	C15	F.1110	080M15	15

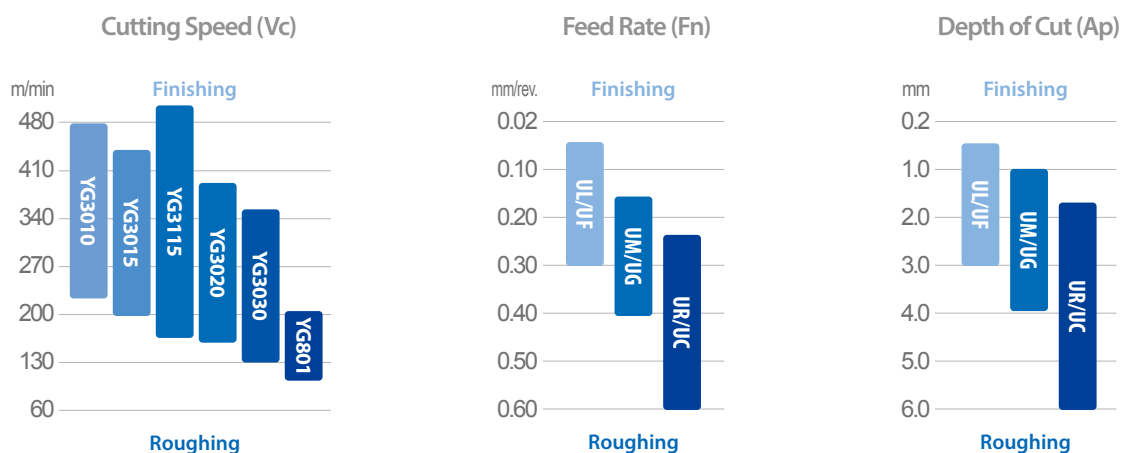

First Choice Grade and Value
YG3030 - Vc 280m/min

P										
Non Alloy Steel, About 0.45% C (Medium Carbon Steel)										
VDI	JIS	DIN	Mat'l No.	AISI/ASTM	SS	AFNOR	UNI	UNE	BS	GOST
2-3	S45C	C45	1.0503	1045	1672	XC42H1TS	C45	F.1140	060A47	45

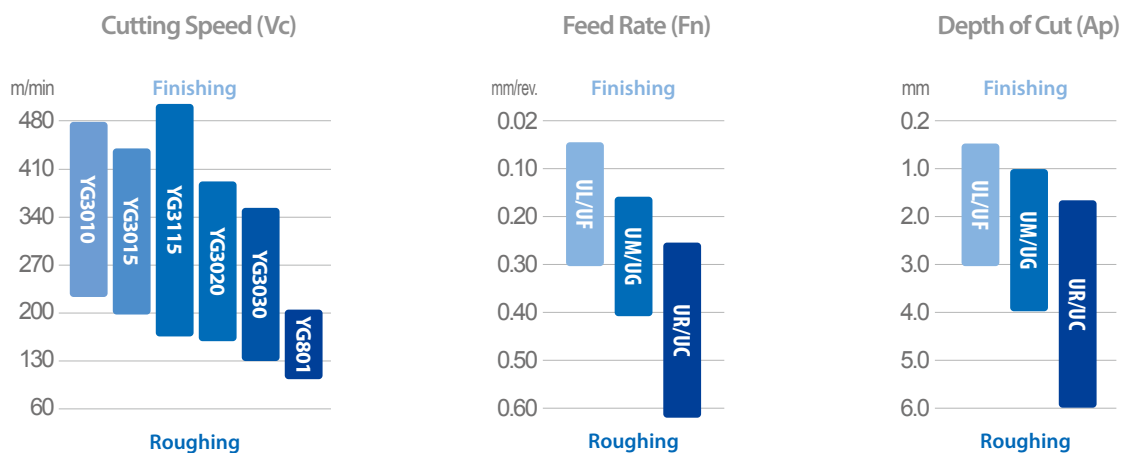

First Choice Grade and Value
YG3115 - Vc 330m/min

Application Guide

Steel Guide

P Low-alloyed Steel										
VDI	JIS	DIN	Mat'l No.	AISI/ASTM	SS	AFNOR	UNI	UNE	BS	GOST
6~9	SCM440	42CrMo4	1.7225	4140	2244	42 CD 4	42CrMo4	F.1252	708M40	38HM

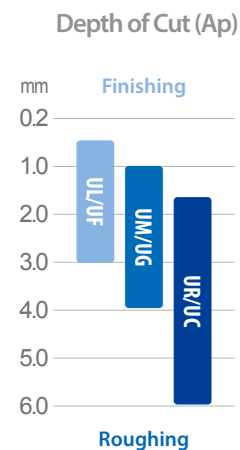
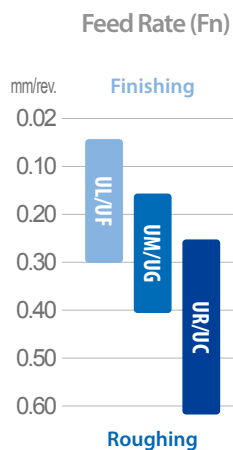
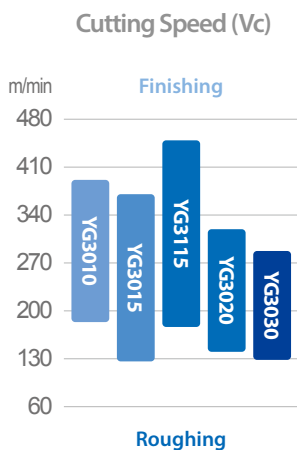

First Choice Grade and Value
YG3020 - Vc 240m/min

P High Alloyed Steel, and Tool Steel										
VDI	JIS	DIN	Mat'l No.	AISI/ASTM	SS	AFNOR	UNI	UNE	BS	GOST
10~11	SKD11	X155CrVMo121	1.2379	D2	2310	Z160CDV12	X165CrMoW12KU	F.5318	BD2	KH12MF

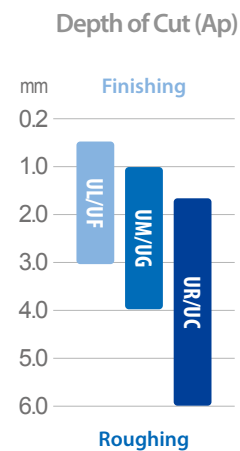
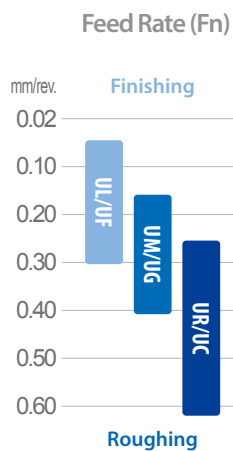
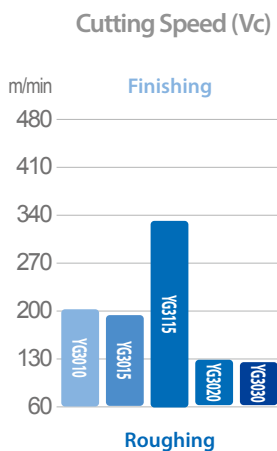

First Choice Grade and Value
YG3115 - Vc 150m/min

Application Guide

Stainless steel Guide

TURNING

PARTING & GROOVING

MILLING

DRILLING

TECHNICAL INFORMATION

M Ferritic / Martensitic Stainless										
VDI	JIS	DIN	Mat'l No.	AISI/ASTM	SS	AFNOR	UNI	UNE	BS	GOST
12~13	SUS430	X6Cr17	1.4016	430	2320	Z8C17	Z8C17	F3113	430S15	12C17

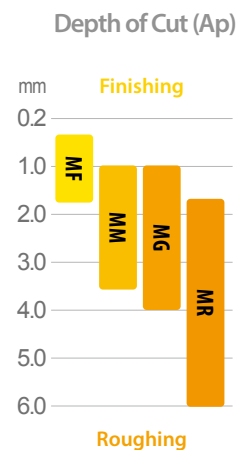
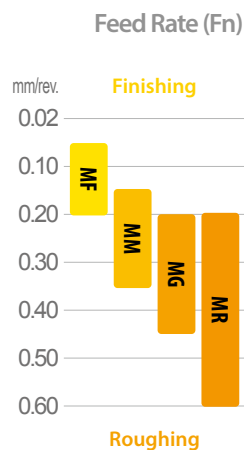
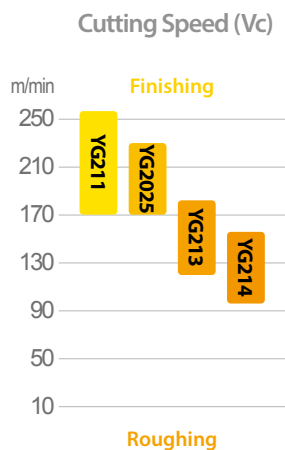

First Choice Grade and Value

Ferritic Stainless steel
 YG213 - Vc 160m/min
 YG2025 - Vc 190m/min

Martensitic
 YG213 - Vc 130m/min
 YG2025 - Vc 160m/min

M Austenitic Stainless steel										
VDI	JIS	DIN	Mat'l No.	AISI/ASTM	SS	AFNOR	UNI	UNE	BS	GOST
14	SUS304	X5CrNi18 9	1.4350	304	2332	Z6CN18 09	X5CrNi18 10	F3551	304S15	03KH18N11

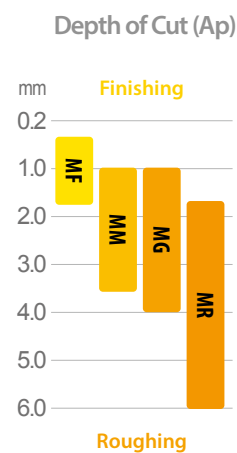
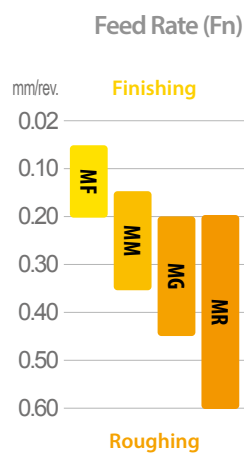
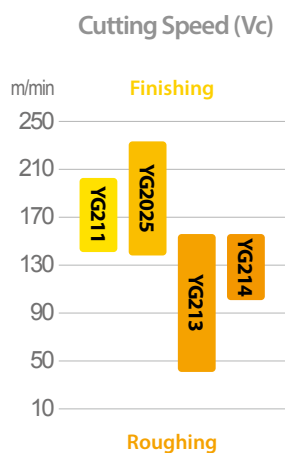

First Choice Grade and Value

YG2025 - Vc 190m/min

Application Guide

Cast iron Guide

Grey cast iron											
K	VDI	JIS	DIN	Mat'l No.	AISI/ASTM	SS	AFNOR	UNI	UNE	BS	GOST
15~16	FC250	GG25	0.6025	A48 40 B	0125	Ft 25 D	G25	FG25	Grade 260	Sc 25	

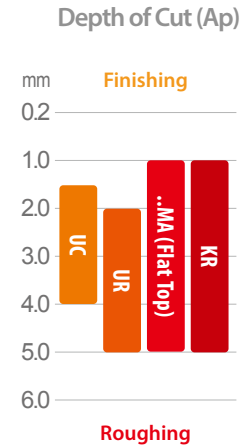
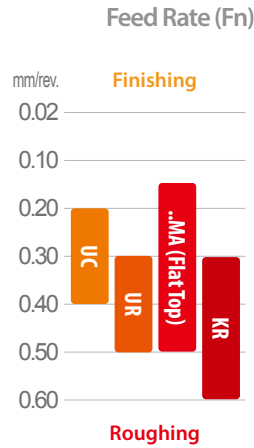
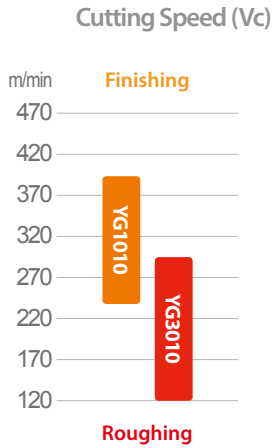

First Choice Grade and Value
YG1010 - Vc 370m/min

Nodular cast iron											
K	VDI	JIS	DIN	Mat'l No.	AISI/ASTM	SS	AFNOR	UNI	UNE	BS	GOST
17~18	FCD500	GGG50	0.7050	80-55-06	0.7050	FGS 500-7	GS 500-7	FGE50-7	SNG 500-7	Vc 50-2	

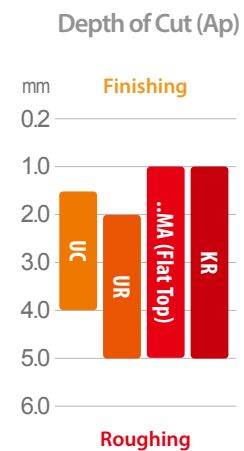
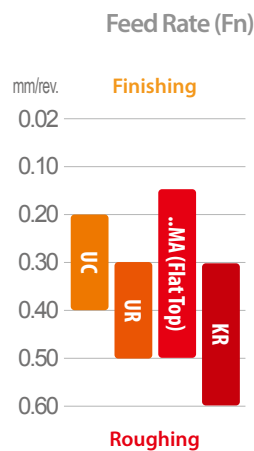
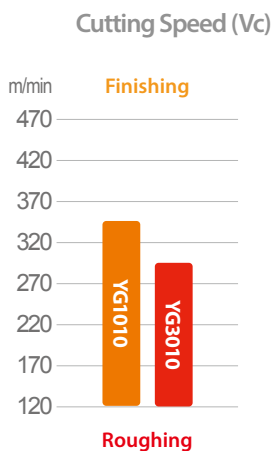

First Choice Grade and Value
YG1010 - Vc 230m/min

Application Guide
HRSA Guide

TURNING

PARTING & GROOVING

MILLING

DRILLING

TECHNICAL INFORMATION

S Superalloys & Titanium Alloys										
VDI	DIN	Mat'l No.	AISI/ASTM	AFNOR	BS	UNS	Brands	UNE	BS	GOST
31-37	NiCr19Fe19NbMo	2.4668	5383	NC19eNB	HR8	N07718	Inconel 718	F.3113	430S15	12C17

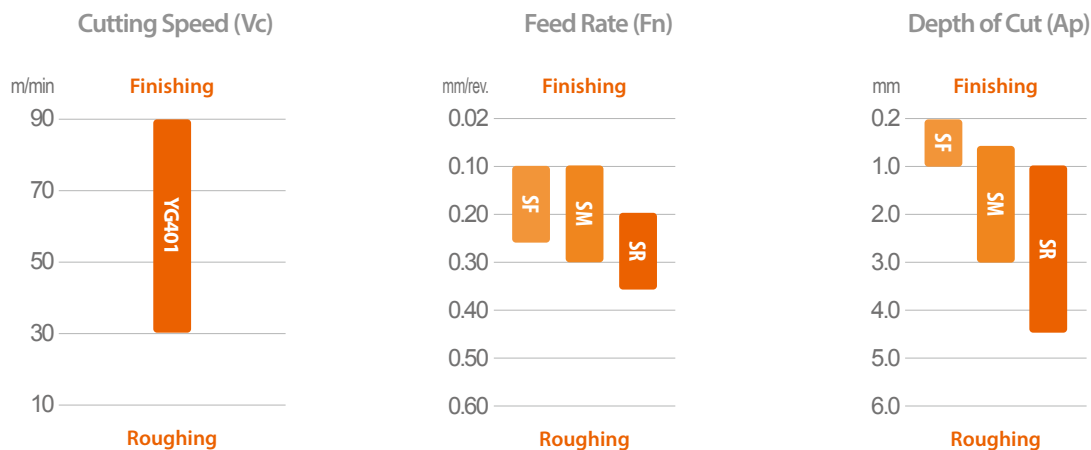

First Choice Grade and Value
YG401 - Vc 50m/min

Surface Roughness Guide

Trouble Shooting

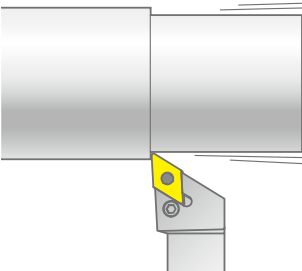
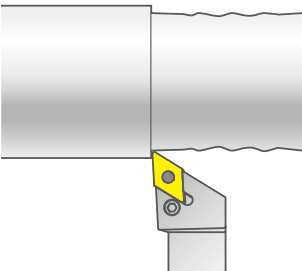
Pattern	Reasons	Solutions
<p>Vibration</p> 	<ul style="list-style-type: none"> - High radial or tangential force - Unstable condition 	<ul style="list-style-type: none"> - Lower depth of cut (ap) - Use sharper chipbreaker - Check stability, and position of tool and workpiece - Reduce the overhang (bigger and shorter tool)
<p>Bad Surface</p> 	<ul style="list-style-type: none"> - Work material is damaged by chips - Feed is too high for corner radius 	<ul style="list-style-type: none"> - Different chipbreaker - Lower depth of cut (ap) - Lower feed - Larger corner radius

Theoretical Surface Roughness

Ra / Rz μm	Insert Corner Radius Code ISO					
	02	04	08	12	16	24
Feed Rate mm/rev						
0.4 / 1.6	0.05	0.07	0.1	0.12	0.14	0.18
1.6 / 6.3	0.1	0.14	0.2	0.25	0.28	0.35
3.2 / 12.5	0.14	0.2	0.28	0.35	0.4	0.49
6.3 / 25	-	0.28	0.4	0.49	0.57	0.69
8 / 32	-	-	0.45	0.55	0.64	0.78

Trouble Shooting

Trouble Shooting Guide map

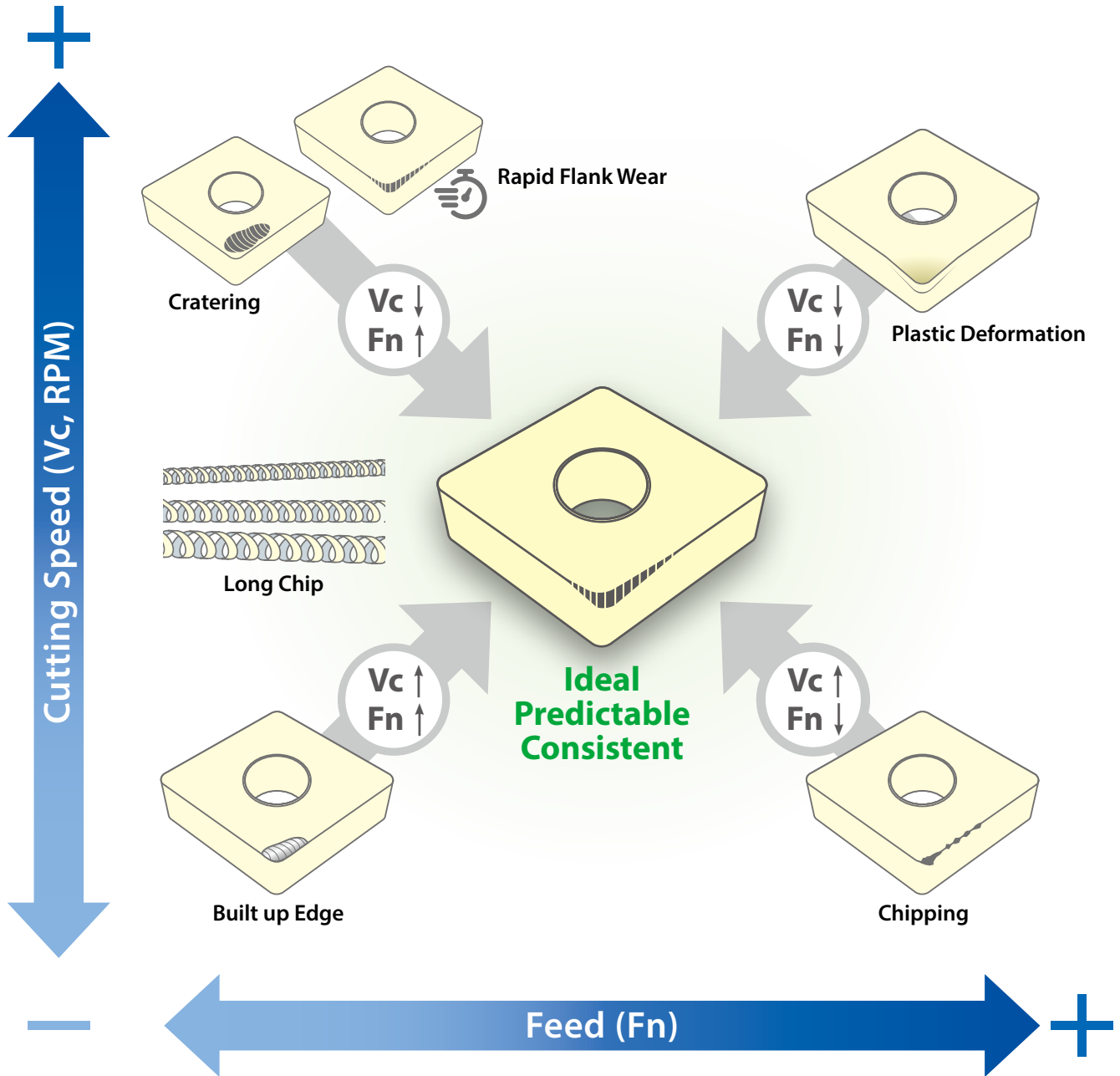

TURNING

PARTING & GROOVING

MILLING

DRILLING

TECHNICAL INFORMATION

Application Guide

Trouble Shooting

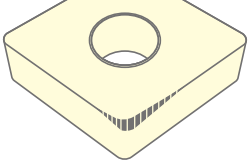
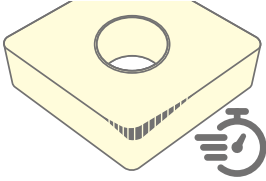
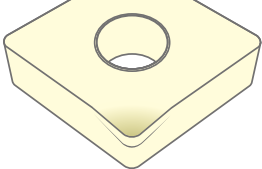
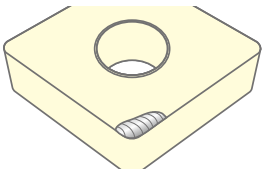
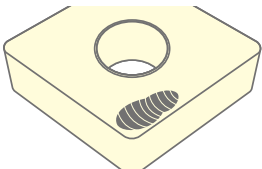
Pattern	Reasons	Solutions
<p>General Flank Wear</p>  <p>Flank face near by corner is abraded</p>	<ul style="list-style-type: none"> - The most ideal wear - Consistent and predictable - General wear behavior when machining condition is normal 	
<p>Rapid Flank Wear</p>  <p>Looks same as general flank wear, but happens quickly</p>	<p>Grade</p> <ul style="list-style-type: none"> - Not enough wear resistance - Too tough grade <p>Heat</p> <ul style="list-style-type: none"> - Cutting speed is too high - Not enough coolant 	<ul style="list-style-type: none"> - More wear resistant grade - Reduce the cutting speed (Vc, SFM, RPM or SFPM) - Optimize coolant - Increase Feed (Fn) if feed is low
<p>Plastic Deformation</p>  <p>Deformed Edge</p>	<ul style="list-style-type: none"> - Excess thermal load - Excess mechanical load 	<ul style="list-style-type: none"> - Reduce cutting temperature - More wear resistant grade - Reduce the cutting speed (Vc, SFM, RPM or SFPM) - Lower feed (Fn) - Lower depth of cut (ap) - Optimize coolant
<p>Built up Edge</p>  <p>Workpiece material is welded on the cutting edge</p>	<ul style="list-style-type: none"> - Sticky materials (low carbon steel, Stainless steel, non-ferrous metal, heat resistant super alloys) - Too low cutting speed 	<ul style="list-style-type: none"> - Increase cutting speed - Lower feed rate - Sharper chipbreaker & geometry - Use high pressure coolant - Use PVD grade - Use Positive Insert
<p>Cratering</p> 	<p>Heat</p> <ul style="list-style-type: none"> - Cutting speed is too high - Too tough grade 	<ul style="list-style-type: none"> - Reduce cutting temperature - Lower cutting speed (Vc, SFM, RPM or SFPM) - Adjust Feed (Fn) - Harder grade

TURNING

PARTING & GROOVING

MILLING

DRILLING

TECHNICAL INFORMATION

Application Guide

Trouble Shooting

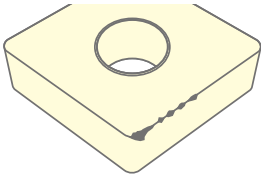
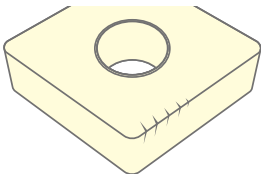
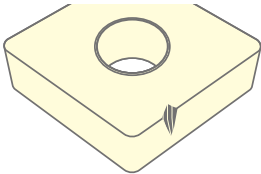
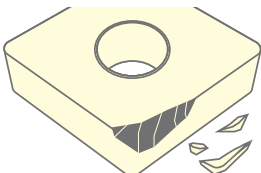
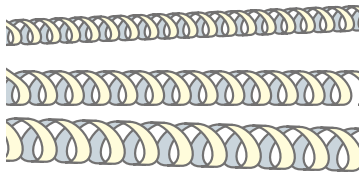
Pattern	Reasons	Solutions
Chipping 	<ul style="list-style-type: none"> - Unstable machining condition (Vibration) - Grade is too hard / brittle - Cutting edge is too sharp 	<ul style="list-style-type: none"> - Focus on stabilizing cutting condition - Reduce overhang (shorter and bigger tool) - Tougher grade - Tougher chipbreaker
Thermal Crack 	<ul style="list-style-type: none"> - Thermal stress due to rapid change of temperature 	<ul style="list-style-type: none"> - Tougher grade - Lower cutting speed (Vc, SFM, RPM or SFPM) - Lower feed (Fn) - Sharper chipbreaker - Change coolant / dry cut
Notching 	<ul style="list-style-type: none"> - Improved edge strength work piece has hardened skin 	<ul style="list-style-type: none"> - More wear resistant grade - Reduce the cutting speed (Vc, SFM, RPM or SFPM) - Adjust Feed (Fn) - Lower depth of cut (ap) - Optimize coolant - Go for tougher chipbreaker
Breakage (Mechanical Fracture) 	<ul style="list-style-type: none"> - Mechanical load is too heavy (feed or depth is too high) - Heavy interrupted cut - Grade is too hard for work material - Unstable machining (vibration) - Cutting speed is too low - Impurities in work material 	<ul style="list-style-type: none"> - Lower feed (Fn) or depth of cut (ap) - Tougher grade - Reduce overhang and check stability of tool and work material - Higher cutting speed (Vc, SFM, RPM or SFPM)
Long Chip 	<ul style="list-style-type: none"> - Feed is too low for chip breaking - Depth of cut is too shallow for corner radius - Chip area (Fn x Ap) too low 	<ul style="list-style-type: none"> - Higher feed - Sharper chipbreaker - Higher depth of cut - Select a smaller corner radius

Technical Information

Comparison Chart - Turning Chipbreakers

Negative Inserts

ISO	Application	YG-1	SANDVIK	ISCAR	KENNAMETAL	Seco	Walter	Mitsubishi	Kyocera	Tungaloy	Sumitomo	Taegutec	Korloy
P	Super Finish	SF	-	SF	FF (G-class), WF, UF	FF1, FF2	FP5, FV5	PK (G-class), FY, FH, FS	DP (G-class), GP WQ	01, TF	FA, FL, FB	FA	VL
	Finish	UF	QF	F3P, NF	FN	MF2	NF4, NF3	FP, C	PP, GP DP, XF, XP	TS, TSF, ZF, 11, NS, NM, CB	LU, FE, SU	FLP, FA, FS, GG-FU, FX, FLP, FG, FM	VF, VB
		PSF	XF	NF, TF	FN	MF2	MP3	FP, FH	HQ	TSF	NSU	FG, FM	VQ
		UL	PF, XF		FN, MN	MF3	NS6	C (Cermet)	CQ, VC, PP	AS	SE	MLP, FC, FT	VQ, VC
	Semi Finish	UM			-	MF5	MP3	SH, SA, LP	PQ, CJ, VF, XQ	ZM, AM	SX		LP
		Medium	UG	PM, QM, XM	PP, TF, M3P, M4PW	MN	M3, M5, MR3	NM4, MP5, MU5, NM6	MA, MH, MP MV	GS, PS, PG	TM AM, DM, ZM	GU (□UG□), GE, UX	MLP, MC, MGP, PC, MM
	Rough	UC	PR	GN	MR, RP	MR4, M5, M6	MG-	MG-, None C/B	XS	TH, THS	UZ	MT, MGP, MG-	B25
		UR	XMR	R3P, NR	RN	MR3, MR6	NR4, RP5, RP7	RP, GH	PT, GT, PH	TU, TRS, TUS	MU, ME, MX	RGP, RT, RX	HR, GR
Wiper	PWM	WF, WR WMX, WM	WF, WG	FW, MW, RW	W-M3, W-MF2, W-MF5, M6, W-R4	NF, NM	SW, MW	WP, WF, WQ, WE	AFW, FW, ASW, SW	LUW, SEW, GUW	WS, WA, WT	VW, LW	
M	Finish	MF	MF	SF, F3M, NF	FF, FP	MF1	NF4, FM5	SH, LM	MQ, SQ	SF, SA	SU, EF	EA, SF	VP2, MP
	Medium	MM	MM	M3MW, TF, M3M	MP, UP	MF4	MM5(NM4)	MS, GM	TK, MS	SM, SS	GU	EM, ML	HS, MM
		MG		VL, PP	MR		RM5, NR4	MM, ES	SG, SX	S, TA	EX, EG		
Rough	MR	MR, XMR, MRR	GN, R3M, NR	P, RP	M5, M6 MR7, RR6	NRS	GH, RM	MU	TH, SH, TU	MU, HM, EM	ET	GS, RM	
K	Finish	UC	KF	M3P, GN	T-20, FN, MT	MF3, MF5, M4	NM, MK5	LK, MA	None C/B, C	CF	UZ	MT	MP
	Medium	UG	KM	GN, A	UN(RP), T-20	M5	NM5, RK5	MK, GK	KQ, KG	CM, None C/B	GZ	MG-	B25, MK
	Rough	..MA	KR, KRR	NR, A	MR, S-20, ... MA, T-20	MR7	MV7, RK7	RK, -MA	-MA, GC, KH, ZS	CH	(□UX□)	KT, RT	-MA, RK
S	Super Finish	SF	SF	SF	FS (G-class) LF (G-class)	MF1	NF4	FJ(G-class)	MQ	-	EF	EA, SF	VP1
	Medium	SM	NGP, SM	PP, TF, VL	MS, GP, P, UN	MF4	NMS, NMT	MJ(G-class), MS	SQ, MS, MU, TK	HRM HMM	EX	EM MGS, MP, MK	VP3
	Rough	SR	SR, SMR	MR	RP	MR3, MR4	NRS, NRT	RS, GJ	SG, SX	SA	MU	ET	VP4

Positive Inserts

ISO	Application	YG-1	SANDVIK	ISCAR	KENNAMETAL	Seco	Walter	Mitsubishi	Kyocera	Tungaloy	Sumitomo	Taegutec	Korloy
P	Finish	PF	PF	PF, F3P	FP	FF1	FP4	SV, FP	GP	PSF, PF	FB, LU	FA, FG	VL, VF
		UF	PF, UF UM	PF, F3P SM, 14	11, UF	F1	FP4, PS5	SMG(G-class), FV, LP	CF, PF, DP, PP, VF	01, TSF	FP, SU, SC	FX, GT-SL, GT-SA, GT-SM	VL
	Medium	PM	SM, M3P	MF	MF2, F2	MP4	MV	HQ, GK	PSS, PS	SU, SC	FM, PC, MT	MP	
		UG	PM, XM, XF	SM, M3P	LF, FP (Posi)	M5	FP6, PM5, E47	MP	XQ, XP	PM, TM 23, 24	MU, LB, SF	MT, PMR-	HMP
M	Finish	MF	MF, MMC	PF, SM, M3M, 14	11, UF, GT-LF, FP	F1, F2	FM4	FM, LM	MQ	PSF, PSS, PS	FC, SI LU, SU	FG, SA	VP1
	Medium	MM	MM	M3M, SM	MP, MF	M3	MM4, RM4	MM		PM	MU		VL
K	Medium	UG	KM, KR	SM, 14	MT, T-20, MP, C	M5	F2, FK6, MK4, RK6	MK, None C/B	None C/B	CM, None C/B	MU, None C/B	PC, MT	MP, C25
S	Super Finish	SF	GT-UM		GT-HP, LF	GT-F1	GT-PF2	FS(G-class) LS(G-class)				GT-FGS, SA	VP1
	Finish	SM	MF, UM	SM, PF, F3M, 14	FP, LF	F1, F2	PF4, PS5	FS-P(G-class) LS-P(G-class)	MQ	PSF	SI	FG	VL
	Medium	SR	MM	M3M, SM		MF2	PM5	LS, MS		PSS, PS		PC	MP
N	Finish	AL	AL	AS	HP	AL	MN2	AZ	AP, AH	AL, PP	AG	GT-SA, FL	AK, AR



Technical Information

Comparison Chart - Turning Grades

CVD Coated

ISO	YG-1	ISCAR	SANDVIK	SECO	PRAMET	KENNAMETAL	TUNGALOY	mitsubishi	WALTER	TAEGUTEK	KORLOY	SUMITOMO	KYOCERA
P	YG3010	IC8150 IC9150 IC9015	GC4415 GC4305 GC4315	TP0501 TP1500 TP1501	T9310 T9315	KCP05B KCP05 KCPK05 KCP10B KCP10	T9205 T9105 T9215 T9115	UE6105 UE6110 MY5015 MC6015	WPP10G WPP01 WPP05S WPP10S	TT8105B TT8115B TT8105 TT8115	NC3215	AC8015P AC810P AC700G	CA510 CA515 CA5505 CA5515
	YG3115	IC8150 IC9150	GC4315 GC4415	TP1501 TP1500	T9315	KCP10 KCP10B	T9115 T9215	MC9015 MC6115 UE6110	WPP10 WPP10S	TT8115 TT8115B	NC3215	AC8015P AC8020P AC810P	CA515 CA5515
	YG3020	IC8250 IC9250	GC4425 GC4325	TP2500 TP2501	T9325	KCP25 KCP25B	T9225 T9125	MC6025 UE6020	WPP20G WPP20S WMP20S	TT8125B TT8125 LC225P	NC3120 NC3225	AC8025P AC820P	CA025P CA525 CA5525
	YG3030	IC8350 IC9350	GC4235 GC2135 GC4035	TP3500 TP3501	T9335	KCP30B KCP30 KCP40B KCP40	T9235 T9135	MC6035 UE6035 UH6400	WPP30G WPP30S WKP30S		NC3030 NC5330	AC8035P AC830P	CA530 CA5535
M	YG3030	IC6015 IC6025 IC9300 IC520M IC4050 IC635	GC2015 GC2025 GC2035 GC235	TM1501 TM2501 TM3501	T7325 T7330 T7335	KCM15B KCM15 KCM25B KCM25 KCM35B KCM35	T6120 T6020 T6130 T6030	MC7015 MC7025 US7020 US735 UH6400	WMP20S	TT9215 TT9225 TT9235	NC9115 NC9125 NC9135 NC5330	AC6020M AC610M AC6030M AC630M AC6040M AC830P	CA6515 CA6525
	YG2025	IC9025 IC9325	GC2220	TM2501 TM2000		KCM25	T6120 T9125	MC7025 US7020		TT9225 TT5100		AC6020M AC6030M	CA6525
K	YG1010 YG1001	IC5005 IC5010 IC4028 IC8150	GC3205 GC3210 GC3215	TK0501 TK1501	T5305 T5315	KCK05 KCK05B KCK15 KCK15B KCK20 KCK20B KCPK05	T5105 T515 T5115 T1215 T1115 T5125 T5020	MC5005 UC5105 MC5015 UC5115 MY5015	WKK10S WKK20S WAK30 WKP30S WKK10 WKK20	TT3005 TT7005 TT7310 TT7015	NC6310 NC6315 NC5330	AC4010K AC405K AC4015K AC415K AC420K AC8025P	CA310 CA315 CA320 CA4505 CA4515

PVD Coated

P	YG801	IC807 IC830 IC507 IC908	GC1025	TP1030 TP1020	T6310 T8430 T8345	KU10T KCU10 KT315 KU25T KC5010	AH330 AH725 AH730 SH725 SH730	VP10RT MS6015 VP15TF VP20MF VP20RT UP20M	WTA43 WTA41	TT4410 TT9020 TT4430 TT9080 TT8080	PC5300 PC5400 PC3035	AC1030U	PR930 PR1225 PR1535 PR1725
M	YG211	IC3028 IC907	GC1105 GC1115 GC2015	TS2000 TS2050	T6310 T8315	KCU10 KCU5010	AH120 AH140 AH630 AH645	VP10RT	WSM21 WSM01 WSM10S	TT5030	PC8105 PC8110	SC520U AC1030U	
	YG401	IC807						MP9005		TT5080	PC8115	AC5005S	
	YG213	IC908	GC2025	CP200 CP500	T8330 M6330	KCU25 KCU5025	SH725 AH7025	VP15TF VP20MF VP20RT UP20M MP7025	WSM20S	TT9080	PC5300 PC8120 PC9030	AC530U	PR930 PR1225 PR1535 PR1725
	YG214	IC330 IC830	GC2035	CP600	T8430		SH730 GH330 GH730 AH4035		WSM30S	TT8080 TT8020	PC5400		
S	YG401	IC804 IC806 IC830 IC807 IC908	GC1025 GC1105 GC1125	TS2000 TS2050 TS2500 TH1000 CP200	M6330 T6310	KCS10 KCU10 KCU25 KC5010 KC5025	AH110 AH120	MP9005 VP05RT MP9015 VP10RT MP9025 VP20RT	WSM01 WSM10S WSM20S WSM21 WSM30S	TT3010 TT3020 TT5080 TT5030	PC8105 PC8110 PC8115 PC5300 PC5400	AC5015S SC5025S AC510U AC520U	PR005S PR015S PR1535 PR1125 PR1305 PR1310

Non Coated

N	YG10	IC20		KX		K313		HT10	WK1		H01 H05	H1	KW10
----------	-------------	------	--	----	--	------	--	------	-----	--	---------	----	------

Cermet

P10	YT100	IC30N	CT5005 CT5015 CT525 GC1525	TP1030 CMP CM	TT010 TT310	KT5020 KT125 KT150	GT730 GT530 NS520 NS720	UP35N	TN60 TN610 TN620 TN90	CT3000	CN1500 CN2500 CC125	T1500A T1000A T2500Z	TN60 TN610 TN620 TC40N
------------	--------------	-------	-------------------------------------	---------------------	----------------	--------------------------	----------------------------------	-------	--------------------------------	--------	---------------------------	----------------------------	---------------------------------

Technical Information

Comparison Chart - Milling Grades

ISO	YG-1	SANDVIK	SECO	KENNAMETAL	ISCAR	WALTER	TUNGALOY	mitsubishi	TAEGUTEK	KORLOY	SUMITOMO	KYOCERA	HITACHI	DUJET
P	YG712	GC4220 GC1130	T250M MP3000	KC715M KC522M KC635M		WKP25S WKP25 WAM10	T3130 GH330	MP8010 MP6120 MP6130 MP9120	TT7070 TT7080 TT7030	PC3700 PC3600 PC3500	ACP2000 ACZ310	PR730	CY9020 JP4020 TB6045	JC5003
	YG713	GC4230 GC4330	T350M F25M	KC525M	IC950 IC1008	WAM20 WAM30	AH710 AH120 T3225			PC210F	ACP200 ACZ330	PR830 PR630	JP4120 CY250	JC5015
	YG602	GC1030 GC4240	F30M	KC725M KC735M	IC900 IC808 IC908 IC330	WKP35G WKP35S	T3130 AH3035 AH110	VP15TF VP20RT MP9130	TT9030 TT9080	NC5330 PC5300 NCM325 NC5350	ACP3000	PR1025 PR1225	PTH30E JS4060 JP4160	JC5030 JC5040
	YG613	GC4340 GC1040	F40M T60M	KCPM20 KC935M KCPM40	IC830 IC928	WKP45S WKP45X WSP45S	AH725 AH730 GH330 AH130 AH140	FH7020 VP30RT F7030	TT8020 TT8025 TT8080	NC5340 PC5400 NCM335	ACP300 ACZ350	PR1525 PR1230 PR660	JM4160 PTH40H	
M	YG602	GC2030 GC1030	F25M	KC635M KC522M KC725M	IC330	WAM30 WXM35 WSM35	AH725 AH120 GH110 AH730	VP15TF MP7130 MP7030	TT9030 TT9080	PC210F PC5300 NCM325 NC5350	XCU2500 ACM100 ACP200 ACM300	PR1025 PR1225 PR1525 PR630	JX1015 TB6020 CY250 GX2160 JX1045	JC5003 JC5015 JC5030
	YG613	GC2040	F30M F40M	KC722	IC928 IC328	WSP45	AH140 GH340	MP9030 MP7140 VP30RT	TT8080 TT8020	PC9530 NCM335 PC5400	ACP300 ACZ350 ACP400	PR660 PR1535 PR660	TB6045 JX1060 TB6060	JC5040
K	YG5020	GC3220 GC1020	MK1500 MP1500	KC915M	DT7150 IC5100 IC418	WAK15	T1015	VP15TF	TT6290 TT7515 TT6800	NC5330 PC8110	XCK2000	PR1510 PR510		JC5003
	YG501	GC3040	MK2050 MK2000	KCK15 KC520M	IC910 IC810	WKK25S WKP25	T1115 T1215 AH120	MP8010 MC5020	TT6080 TT6030	PC6510 NC5340	ACK200 ACZ310	PR1210 PR905		JC5015
	YG622		MK3000			WKP35	GH110	VP20RT		NC5350 PC5300	ACK300	CA420M		
S	YG602	GC1025 GC1040	F40M MM4500	KC510M KCU30M	IC328 IC408	WSM35S		VP15TF VP30RT	TT9030 TT8020 TT9540	PC5300 PC5400 PC9540	AC520U	CA6535 PR620	ACS05E	
	YG613	S30T S40T	MS2500	KC725M	IC903	WSM45S WSM45X		MP9130	TT8080 TT3540	UPC845		PR660 PR1535		
	YG012	GC1130 GC1030	MP1500 MP3000		IC1008			VP15TF						

ISO ↔ ANSI

ISO	ANSI
CC.. 060201	CC.. 21.50
CC.. 060202	CC.. 21.50.5
CC.. 060204	CC.. 21.51
CC.. 060208	CC.. 21.52
CC.. 09T301	CC.. 32.50
CC.. 09T302	CC.. 32.50.5
CC.. 09T304	CC.. 32.51
CC.. 09T308	CC.. 32.52
CC.. 120402	CC.. 430.5
CC.. 120404	CC.. 431
CC.. 120408	CC.. 432
CC.. 120412	CC.. 433
CN.. 090308	CN.. 322
CN.. 090312	CN.. 323
CN.. 090408	CN.. 332
CN.. 090412	CN.. 333
CN.. 120401	CN.. 430
CN.. 120402	CN.. 430.5
CN.. 120404	CN.. 431
CN.. 120408	CN.. 432
CN.. 120412	CN.. 433
CN.. 120416	CN.. 434
CN.. 160608	CN.. 542
CN.. 160612	CN.. 543
CN.. 160616	CN.. 544
CN.. 190608	CN.. 642
CN.. 190612	CN.. 643
CN.. 190616	CN.. 644
CN.. 190624	CN.. 646
CN.. 250924	CN.. 866
DC.. 070202	DC.. 21.50.5
DC.. 070204	DC.. 21.51
DC.. 070208	DC.. 21.52
DC.. 11T301	DC.. 32.50

ISO	ANSI
DC.. 11T302	DC.. 32.50.5
DC.. 11T304	DC.. 32.51
DC.. 11T308	DC.. 32.52
DC.. 11T312	DC.. 32.53
DN.. 110404	DN.. 331
DN.. 110408	DN.. 332
DN.. 150404	DN.. 431
DN.. 150408	DN.. 432
DN.. 150412	DN.. 433
DN.. 150604	DN.. 441
DN.. 150608	DN.. 442
DN.. 150612	DN.. 443
SC.. 09T304	SC.. 32.51
SC.. 09T308	SC.. 32.52
SC.. 120408	SC.. 432
SD.. 1203	SD.. 42
SC.. 120412	SC.. 433
SD.. 120420	SD.. 435
SD.. 1504	SD.. 53
SE.. 1203	SE.. 42
SN.. 090304	SN.. 321
SN.. 090308	SN.. 322
SN.. 120404	SN.. 431
SN.. 120408	SN.. 432
SN.. 120412	SN.. 433
SN.. 120416	SN.. 434
SN.. 150612	SN.. 543
SN.. 190612	SN.. 643
SN.. 190616	SN.. 644
SN.. 190624	SN.. 646
SN.. 250724	SN.. 856
SN.. 250924	SN.. 866
SP.. 1203	SP.. 42
SP.. 120308	SP.. 422

ISO	ANSI
SP.. 1504	SP.. 53
TC.. 110204	TC.. 21.51
TC.. 110208	TC.. 21.52
TC.. 16T302	TC.. 32.50.5
TC.. 16T304	TC.. 32.51
TC.. 16T308	TC.. 32.52
TN.. 160404	TN.. 331
TN.. 160408	TN.. 332
TN.. 160412	TN.. 333
TN.. 220404	TN.. 431
TN.. 220408	TN.. 432
TN.. 220412	TN.. 433
TN.. 220416	TN.. 434
TP.. 1603	TP.. 32
TP.. 160308	TP.. 322
TP.. 2204	TP.. 43
VB.. 110301	VB.. 220
VB.. 110302	VB.. 220.5
VB.. 110304	VB.. 221
VB.. 110308	VB.. 222
VB.. 160402	VB.. 330.5
VB.. 160404	VB.. 331
VB.. 160408	VB.. 332
VC.. 110301	VC.. 220
VC.. 110302	VC.. 220.5
VC.. 110304	VC.. 221
VC.. 110308	VC.. 222
VC.. 160402	VC.. 330.5
VC.. 160404	VC.. 331
VC.. 160408	VC.. 332
VN.. 160404	VN.. 331
VN.. 160408	VN.. 332
VN.. 160412	VN.. 333
WN.. 060404	WN.. 331

ISO	ANSI
WN.. 060408	WN.. 332
WN.. 060412	WN.. 333
WN.. 080404	WN.. 431
WN.. 080408	WN.. 432
WN.. 080412	WN.. 433
WN.. 080416	WN.. 434

Search

Description	Page
INSERT	
ADKT	149
AOMT	149
APGT	150
APKT	151
APMT	152
CCGT	57
CCMT	57
CNGG	33
CNMA	30
CNMG	31
CNMM	34
DCGT	59
DCMT	59
DNGG	38
DNMA	35
DNMG	35
DNMM	39
DNUX	40
ENMX	153
KNUX	41
ODMT	155
ODMW	155
OFER	156
OFMT	156
ONHU	157
ONMU	157
PNMU	158
RCMT	61
RCMX	62
RDKT	159
RDKW	159
RDMT	160
RDMW	160
RPMT	161

Description	Page
RPMW	161
SCGT	63
SCMT	63
SDCN	162
SDKN	162
SDMT	163
SDMW	163
SEGT	164
SEKT	165
SEMT	166
SEKR	167
SEKN	167
SNMA	42
SNMG	43
SNMM	46
SNMX	168
SPCN	169
SPKN	169
SPKR	169
SPMT	170
SPMX	201
SPUN	171
SYMX	200
TCGT	64
TCMT	64
TDN	119
TDP	119
TDY	119
TNMA	47
TNMG	47
TNGG	49
TNUX	50
TPKT	172
TPCN	173

Description	Page
TPKN	173
TPKR	173
TPUN	174
VBGT	66
VBMT	66
VCGT	67
VCMT	67
VNMA	51
VNMG	51
WCMX	202
WNEX	175
WNGG	56
WNMA	53
WNMG	53
NCBP	132
NCBO	133
NCBF	134
NCPR	135
NCGR	136
NCGS	137
NCFI	138
NCFE	138
NCCH	139
NCTH	140
NCHI	141

Description	Page
TURNING HOLDER	
CKJNR/L	79
MTJNR/L	84
MWLNRL/L	85
PCBNR/L	72
PCLNR/L	93
PDJNR/L	73
PDNNN	73
PSBNR/L	74
PSDNN	74
PSKNR/L	74
PSSNR/L	74
PTFNR/L	75
PTGNR/L	75
PTJNR/L	75
PTTNR/L	75
PWLNR/L	76
SCACR/L	86
SCLCR/L	86
SDJCR/L	87
SDNCN	87
SRDCN	88
SRGCR/L	88
SSDCN	89
SSSCR/L	89
STFCR/L	90
STGCR/L	90
STJCR/L	90
STUCR/L	90
SVHBR/L	91
SVHCR/L	92
SVJBR/L	115
SVJCR/L	92
SVVBN	91
SVVCN	92

Search

Description	Page
TURNING HOLDER	
TCLNR/L	77
TDHNR/L	78
TDJNR/L	78
TDNNN	78
TSDNN	80
TSKNR/L	80
TSSNR/L	80
TTGNR/L	81
TTJNR/L	81
TVHNR/L	82
TVVNN	82
TWLNRL/L	83
...-MCLNR/L	104
...-MDUNR/L	104
...-MTFNR/L	105
...-MTUNR/L	105
...-MTQNR/L	105
...-MWLNR/L	106
...-PCLNR/L	93
...-PDQNR/L	94
...-PDUNR/L	94
...-PSKNR/L	95
...-PTUNR/L	96
...-PWLNR/L	97
...-SCFCR/L	108
...-SCLCR/L	109
...-SDPCR/L	110
...-SDQCR/L	110
...-SDUCR/L	111
...-SRGCR/L	112
...-SSSCR/L	113
...-STFCR/L	115
...-STUCR/L	114
...-SVJBR/L	115

Description	Page
...-SVQBR/L	115
...-SVQCR/L	116
...-SVUBR/L	115
...-SVUCR/L	116
...-TCLNR/L	98
...-TDQNR/L	99
...-TDUNR/L	99
...-TSKNR/L	100
...-TTUNR/L	101
...-TVUNR/L	102
...-TWLNR/L	103

PARTING & GROOVING HOLDER

YTER/L	120
YTFR	122
YTFPR	123
YTER/L-S	124
YTIR/L	125
YGB	126
YGBU	127

DRILL HOLDER

YGSY	203
YGSP	207
YGWC	211

Description	Page
MILLING CUTTER	
...-APKT10-...	178
...-APKT16-...	180
...-ENMX06...	182
...-ENMX09...	183
...-ODMT06-...	185
...-OFER07-...	185
...-ONMU08-...	184
...-PNMU12-...	186
...-RDKT08-...	187
...-RDKT10-...	187
...-RDKT12-...	188
...-SDMW12-...	189
...-SE12T3-...	190
...-SEKT12-...	190
...-SNMX12-...	192
...-SPKN12-...	191
...-TPKN16-...	193
...-TPKN22-...	193
...-TP11-...	194
...-TP16-...	195
...-WN08-...	196

MEMO



A large grid of small squares, typical of graph paper, covering the majority of the page. The grid is composed of light gray dotted lines forming a uniform pattern of squares.

HIGH QUALITY PRODUCTS and ON TIME DELIVERY for WORLD-WIDE CUSTOMERS

Since 1982, YG-1 has been committed to quality, innovation and the unique customer experience. Our performance and experience have granted YG-1 the global impression of one of the leading manufacturers of high quality cutting tool solutions. This global footprint expands over 75 countries, with international logistic centers, pledging to our customers to give the best service available today - and tomorrow.

EUROPE



ASIA PACIFIC



AMERICAS



AFRICA



 YG-1 CO., LTD.

* For the more information on sales network, please contact the head office as below;

HEAD OFFICE

13-40, Songdogwahak-ro 16beon-gil, Yeonsu-gu, Incheon 21984, South Korea

Phone: +82-32-526-0909 <https://www.yg1.kr> E-mail: yg1@yg1.kr



HEAD OFFICE

13-40, Songdogwahak-ro 16beon-gil, Yeonsu-gu, Incheon 21984, South Korea

Notice YG-1 Global head office is relocating from December 2020 to a new address as above;

Phone: +82-32-526-0909

Https://www.yg1.kr **E-mail:** yg1@yg1.kr

Note The information is provided for reference only. Tool specifications are subject to change without prior notice. Although we endeavor to supply accurate and timely information, there can be no guarantee to cover every particular application. YG-1 or publishers are not liable for any damage for use of the information.



Search 'YG-1' on social media outlets

YG1YEIT240714004